

S.N.C.F.

RÉGION DU SUD-OUEST

CARNET

DE

PROFILS ET SCHÉMAS

1958

CARTE DE LA REGION SUD-OUEST

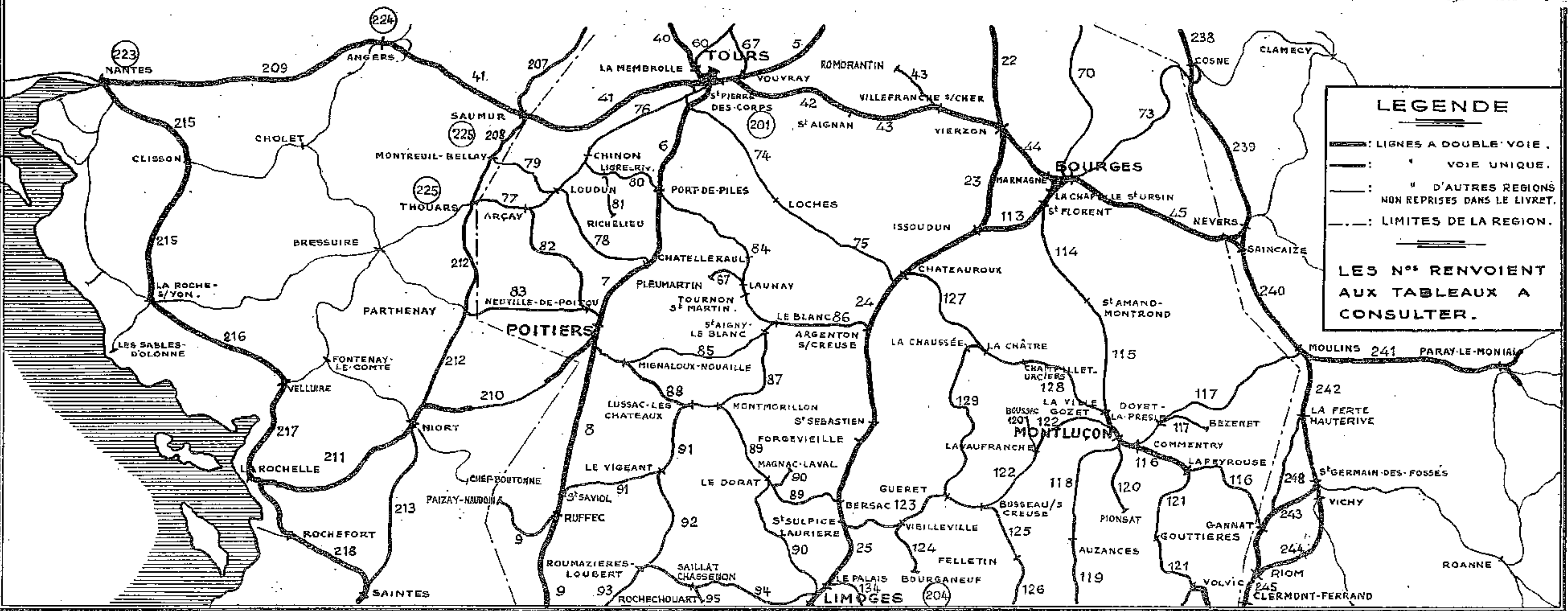
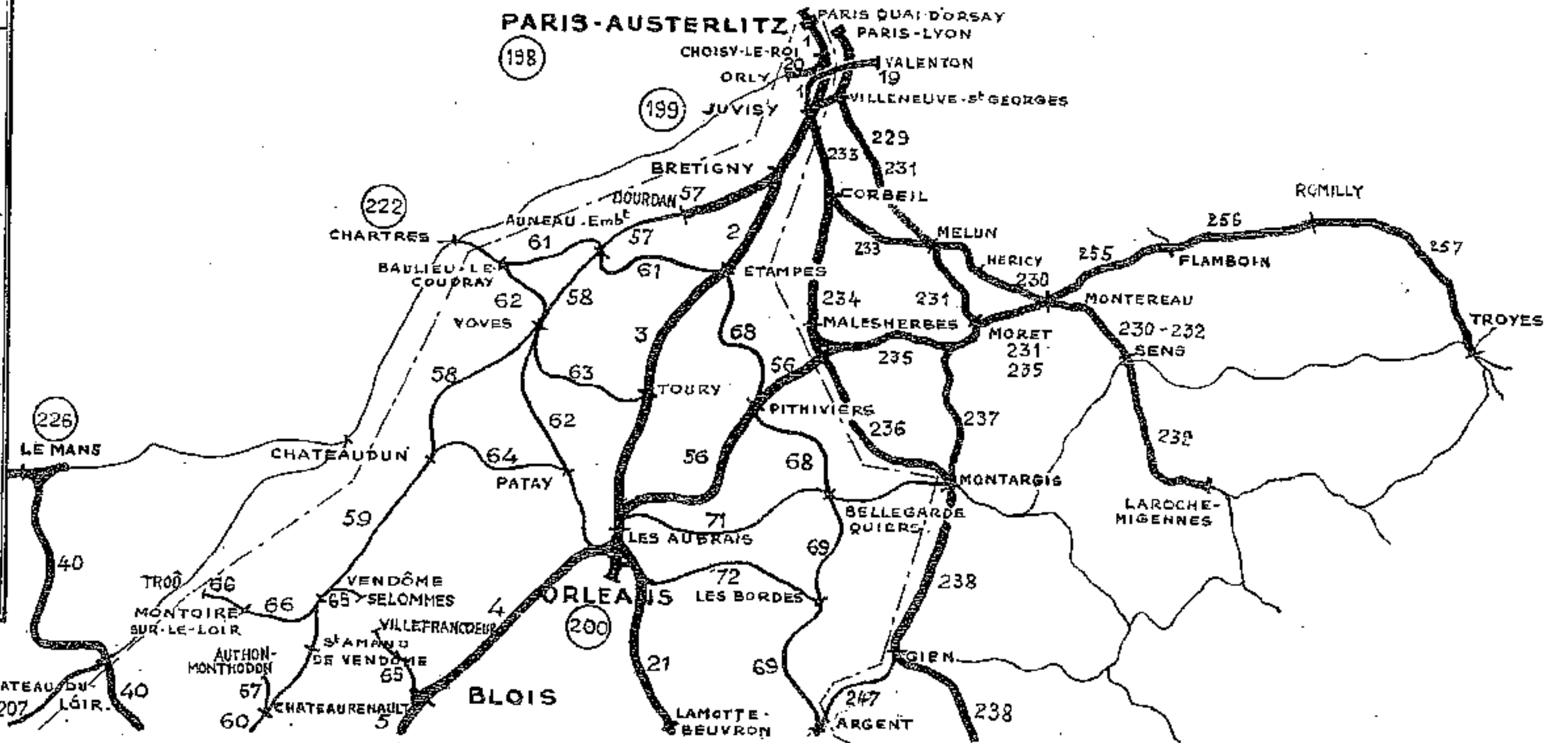
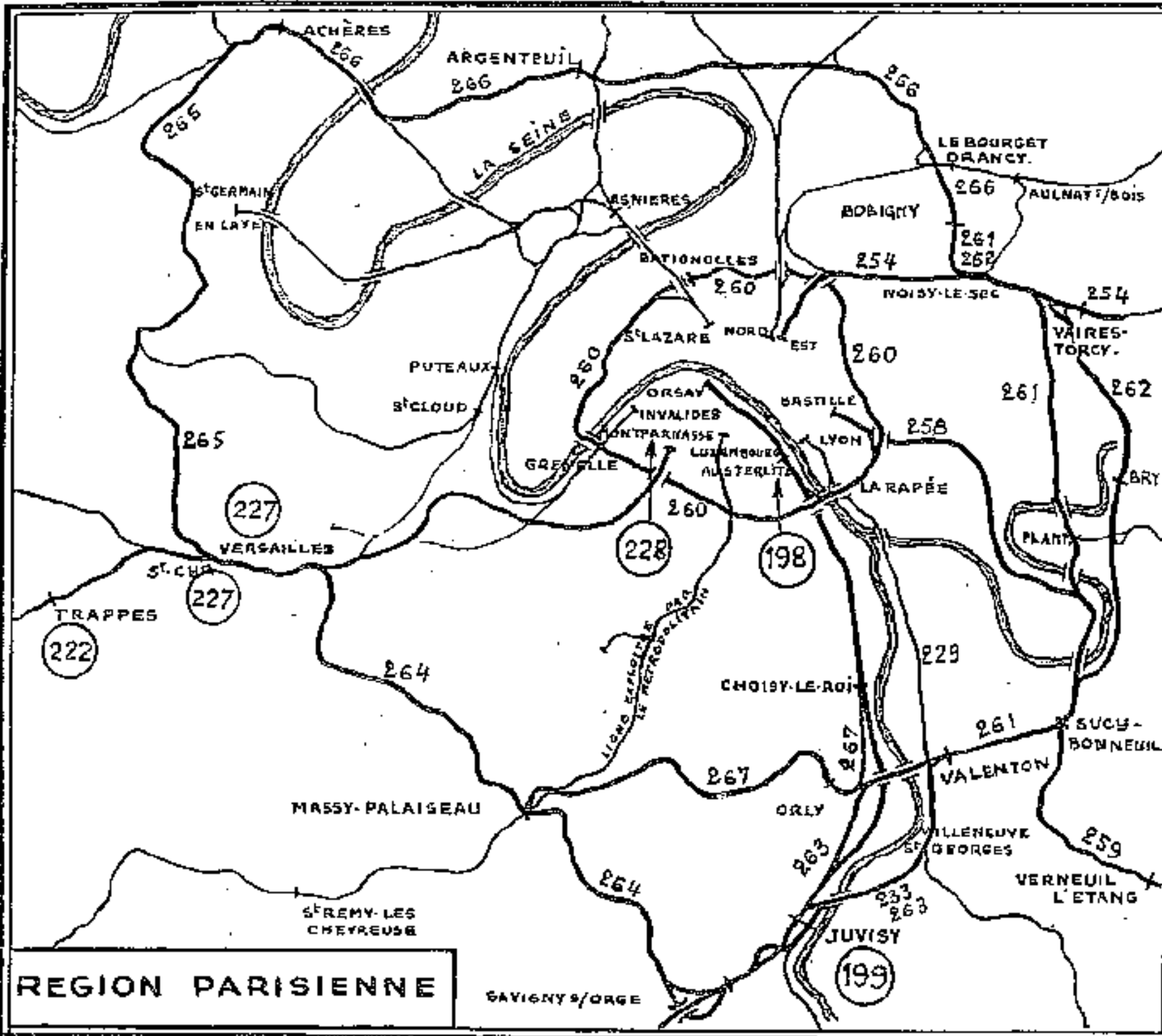

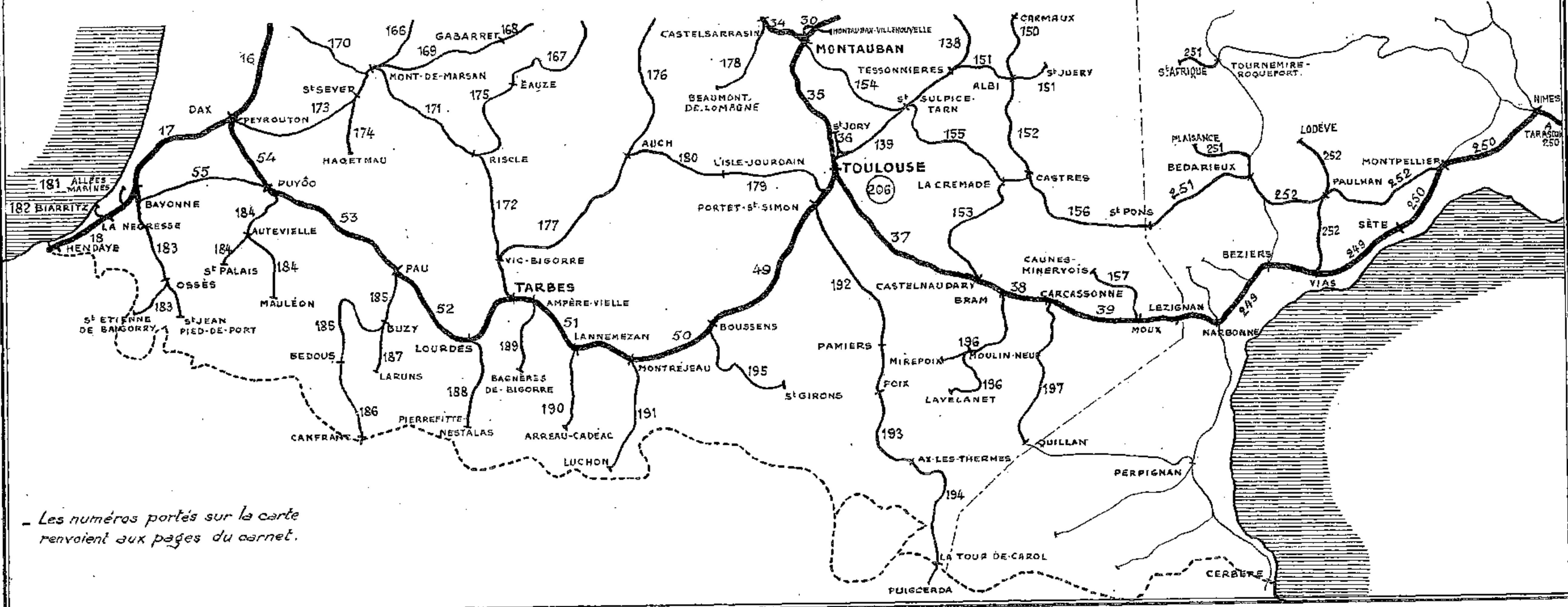
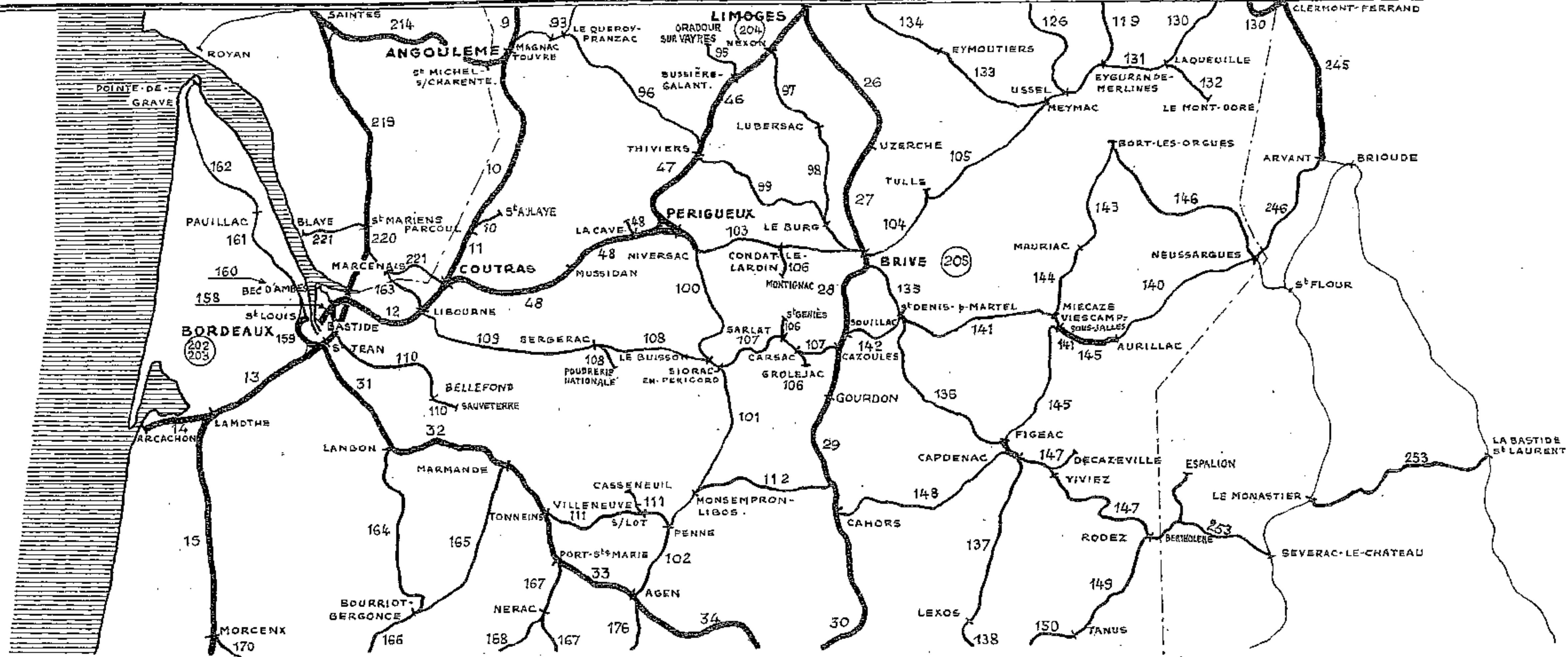

Les numéros portés sur la carte renvoient aux pages du carnet.

Abords de Paris-Austerlitz (voir 198)

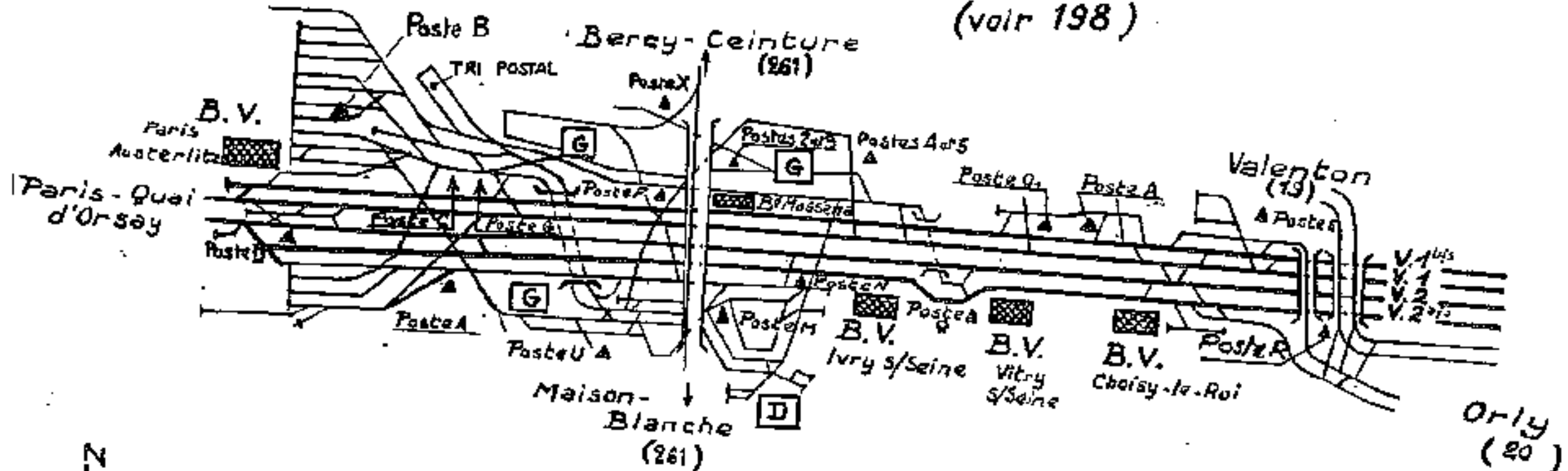

Ligne de Paris à Orléans

Section de Paris à Juvisy

Abords de Juvisy (voir 199)

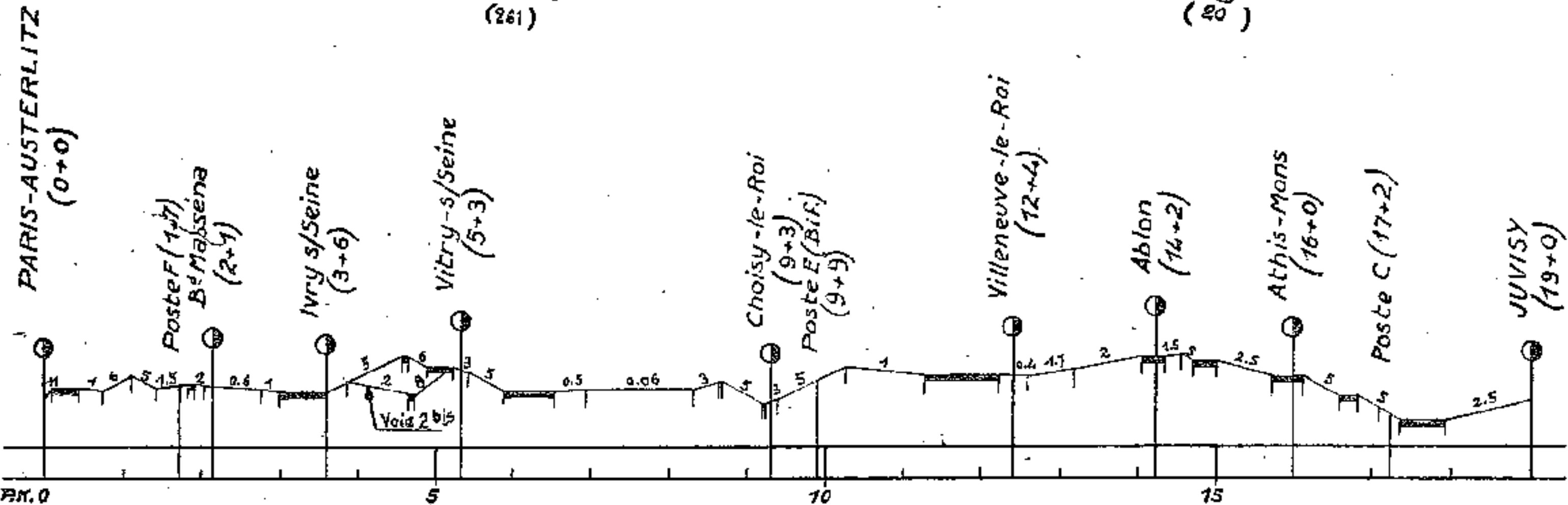
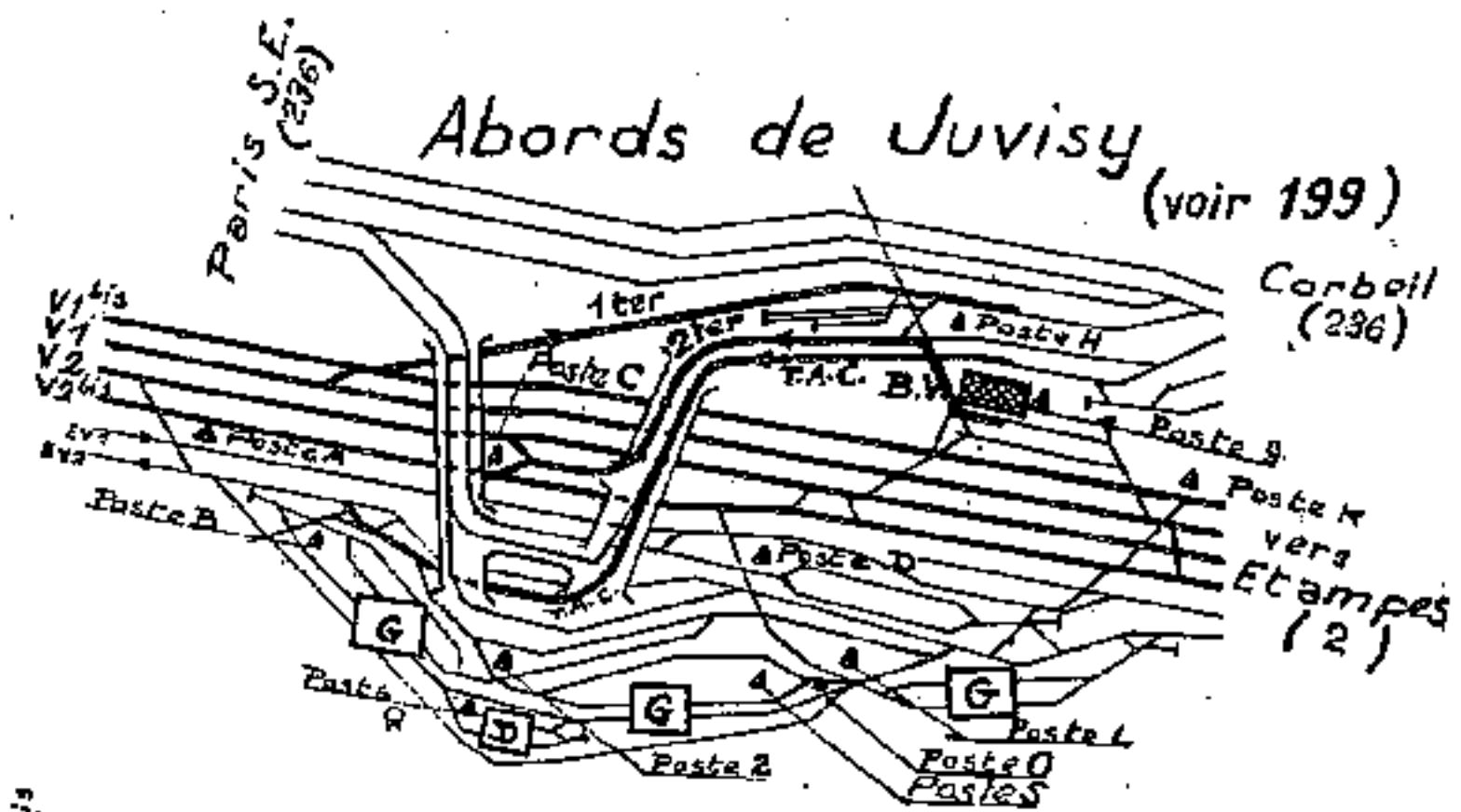

Voies de liaison S.O.-S.E. vers Carbeil

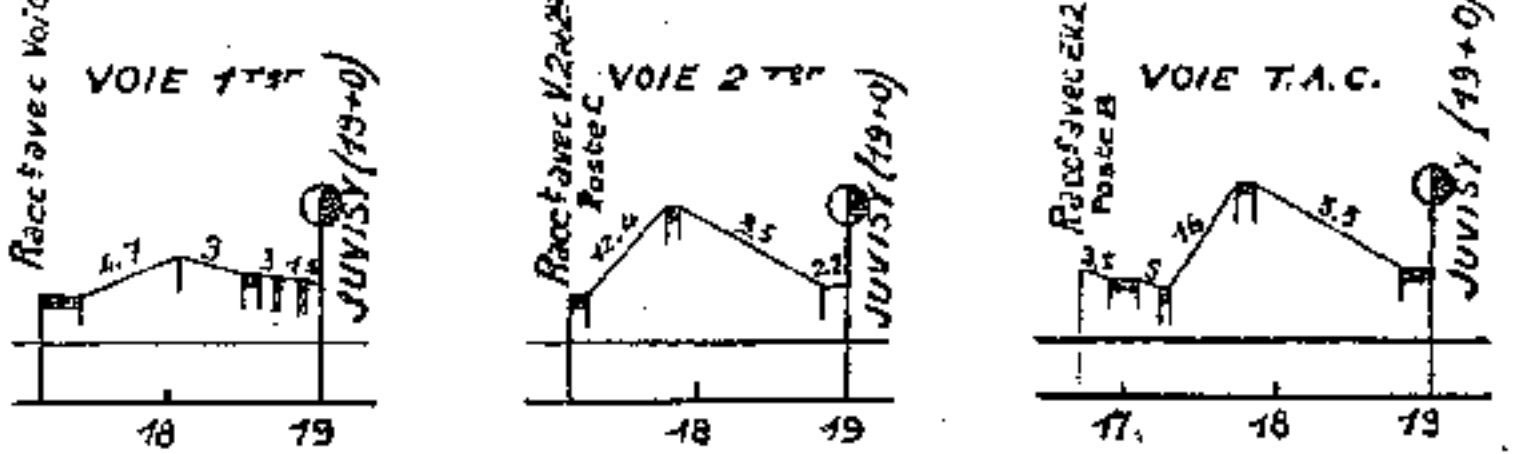

Abords d'Etampes

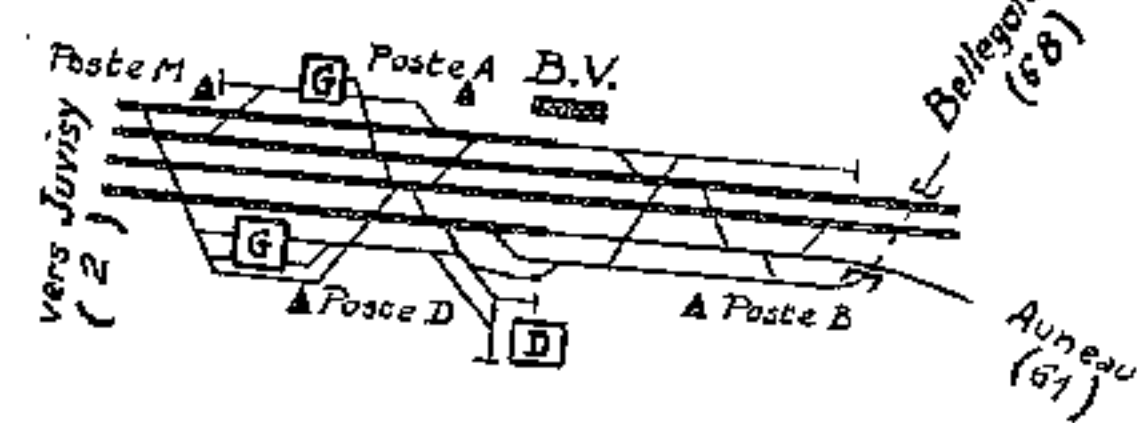

Abords de Toury

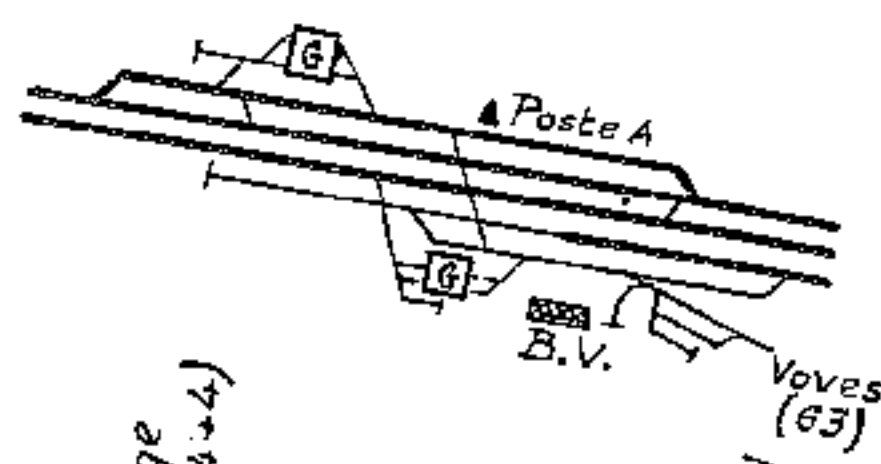

Ligne de Paris à Orléans
Section d'Etampes à Orléans

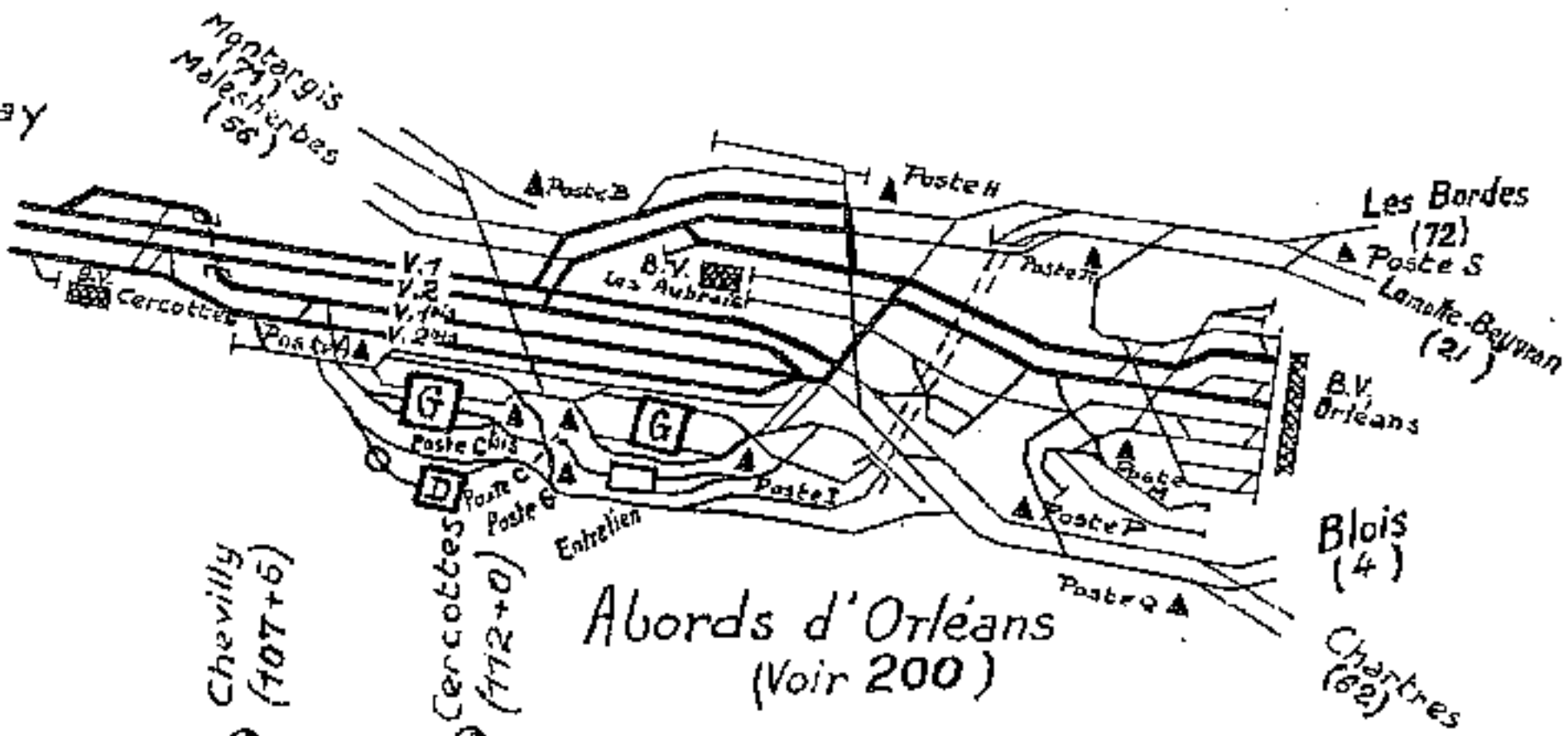
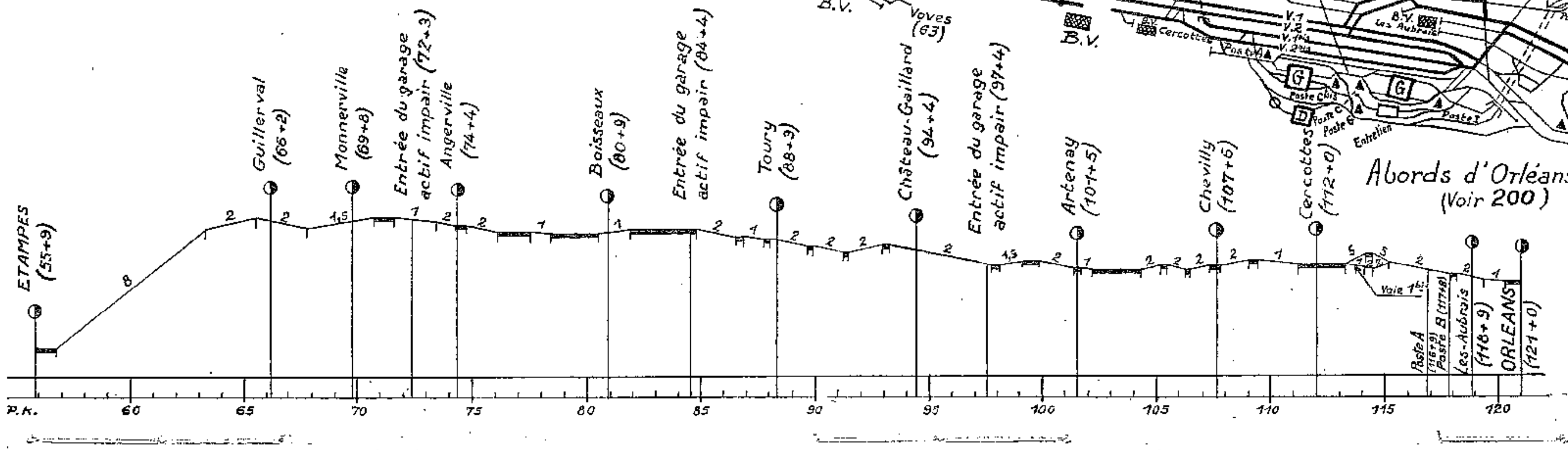

Abords de Juvisy
(Voir 199)

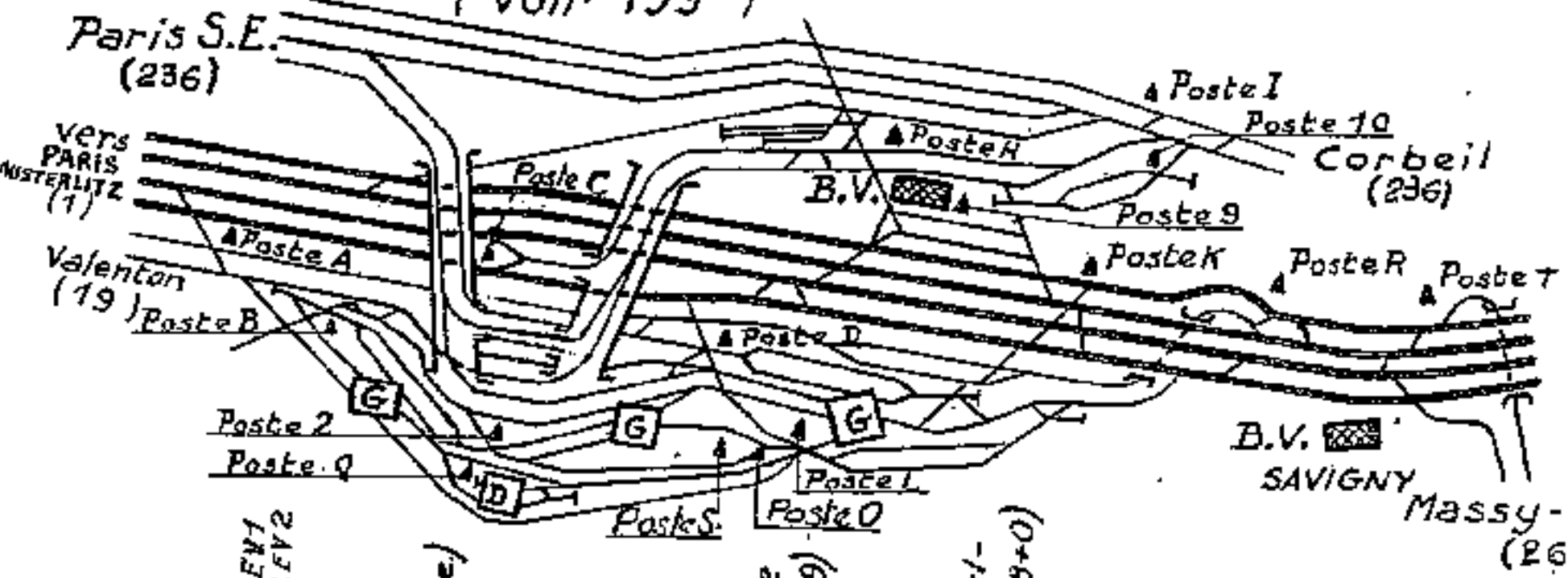

Abords de Brétigny

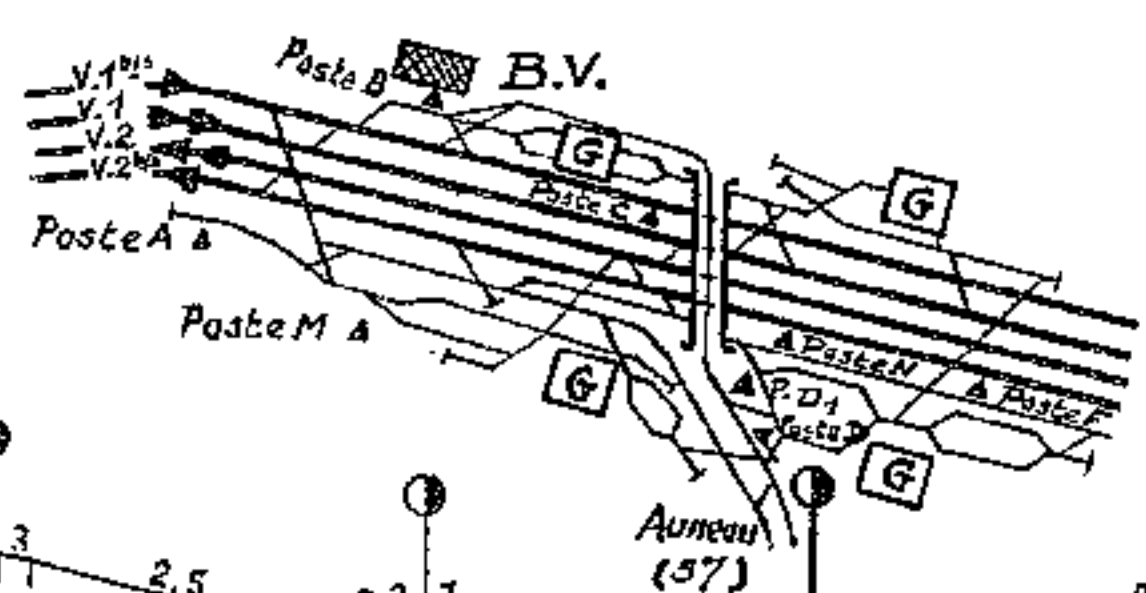

Ligne de Paris à Orléans
Section de Juvisy à Etampes

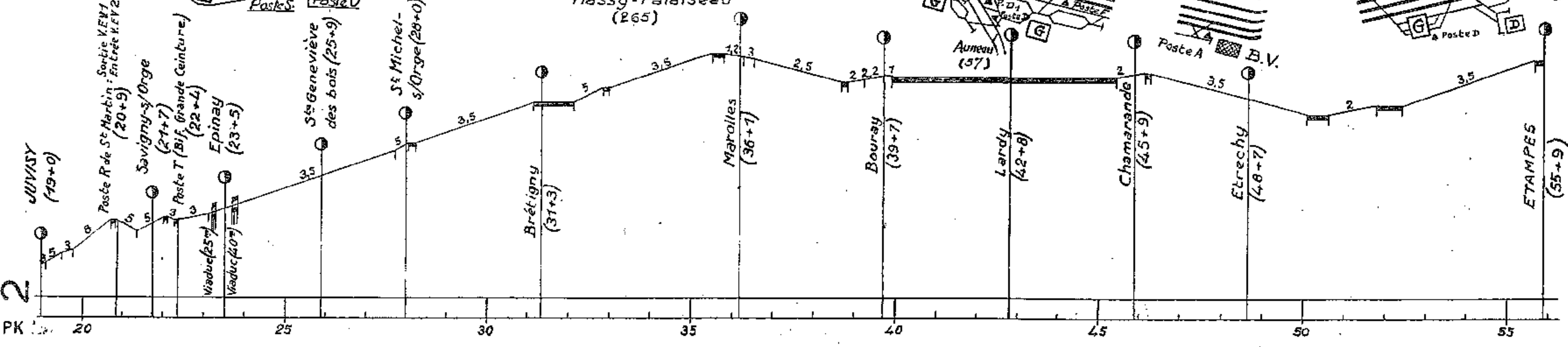

Abords d'Etampes

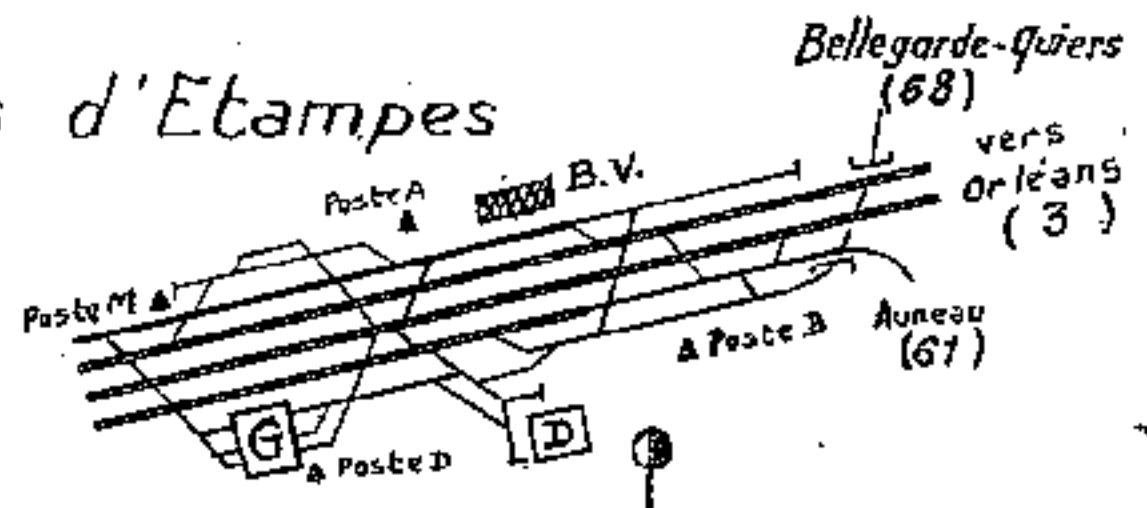

Abords de Blois

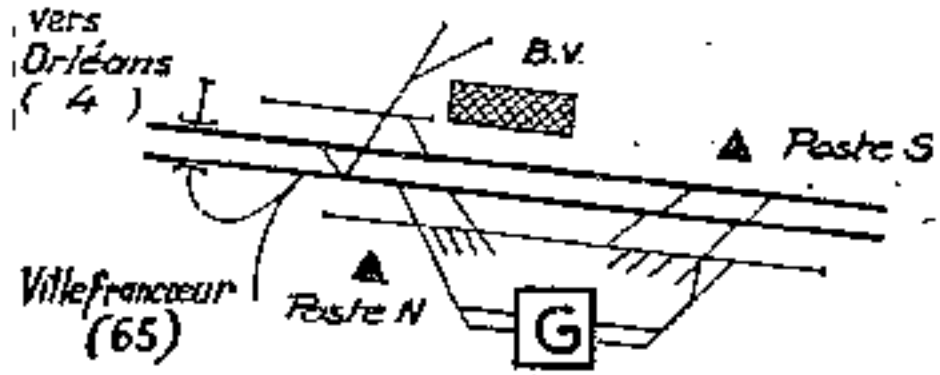

Ligne d'Orléans à Tours

Section de Blois à Tours

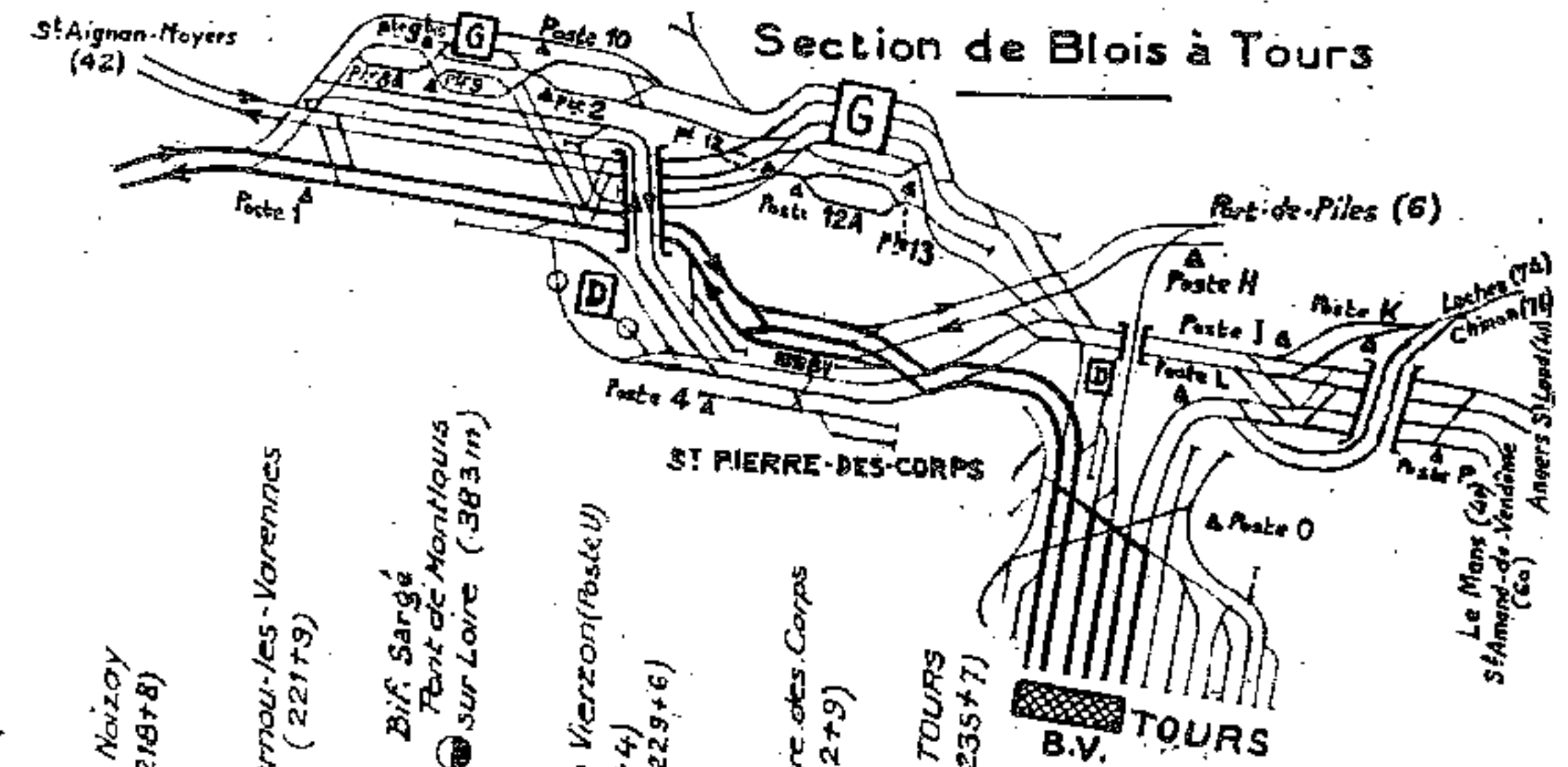

Abords de Vouvray

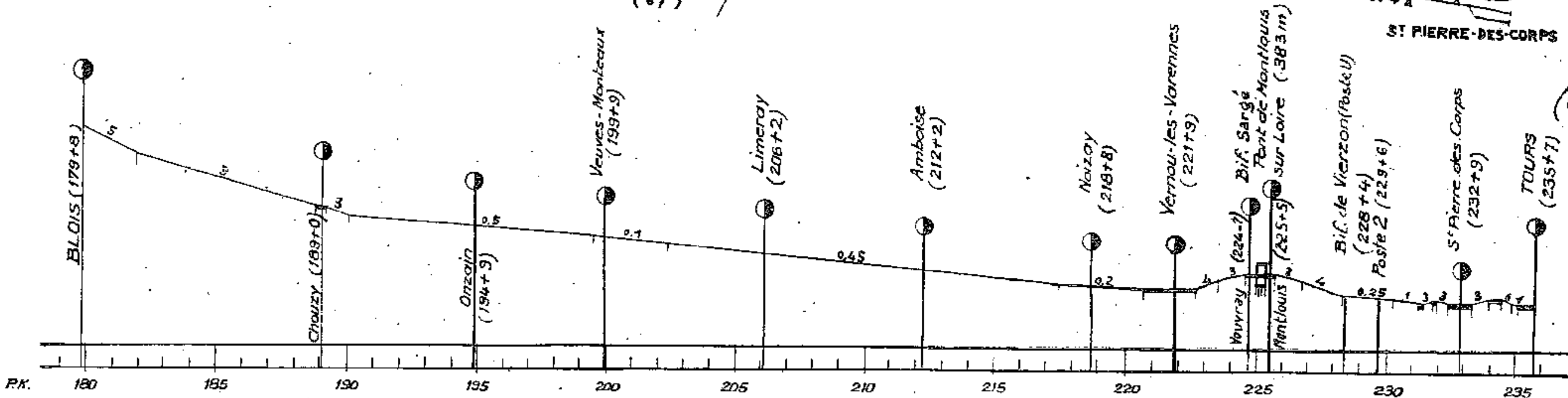
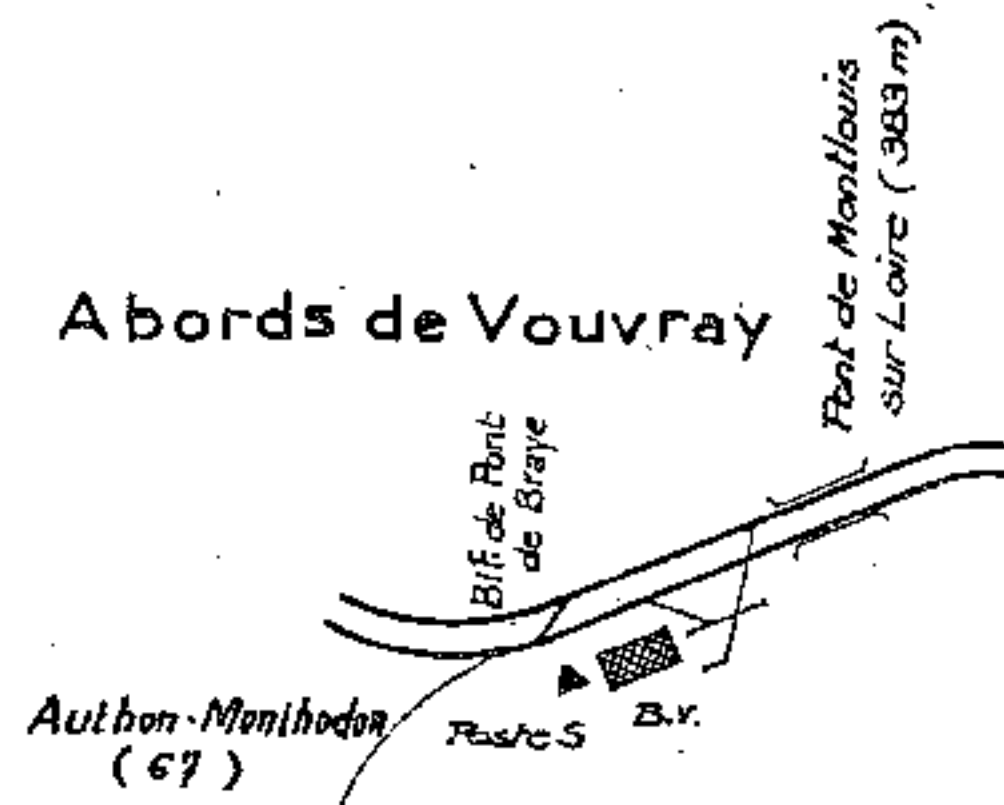

Abords de Tours -
S. Pierre des Corps
(voir 201)

Abords d'Orléans (voir 200)

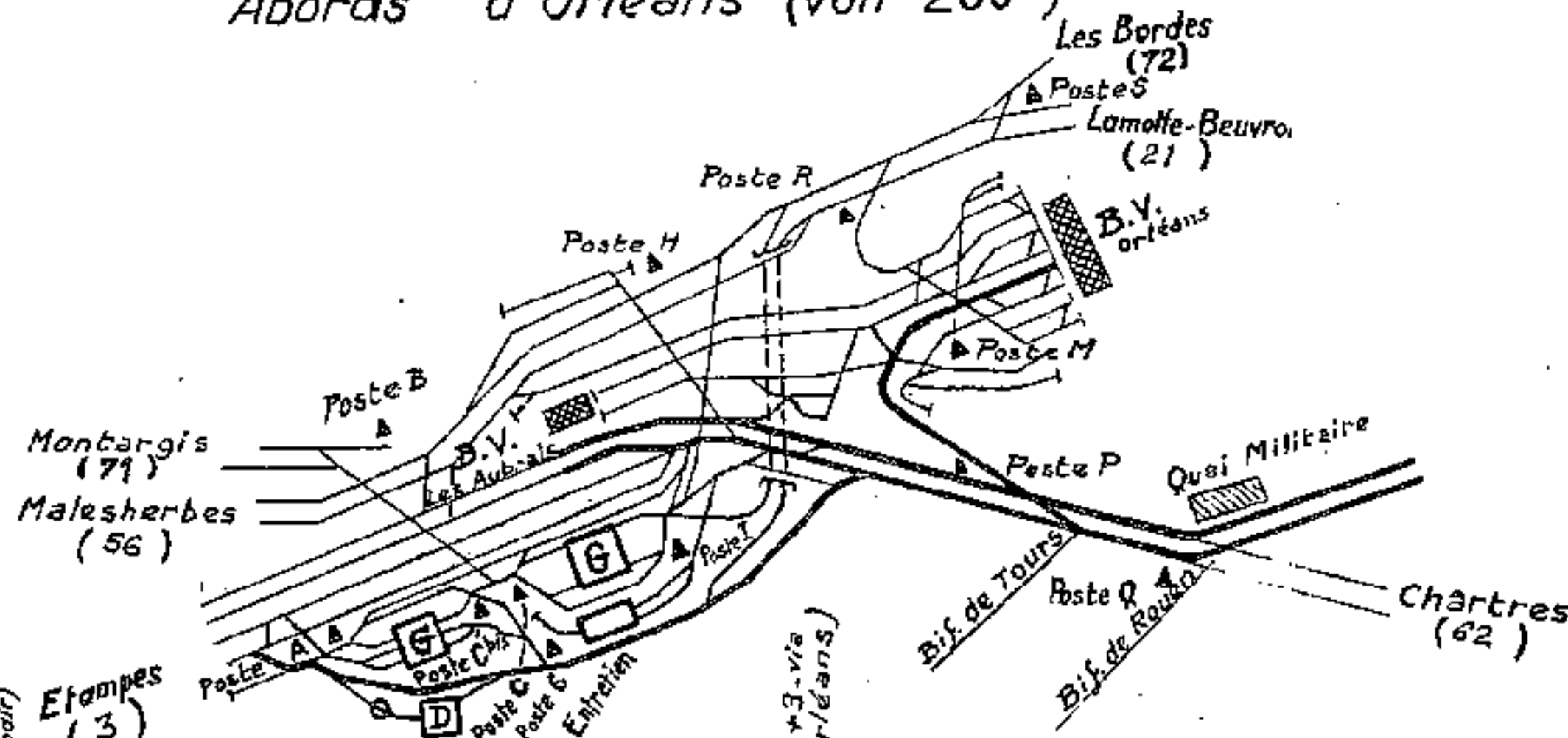

Ligne d'Orléans à Tours

Section d'Orléans à Blois

Abords de Blois

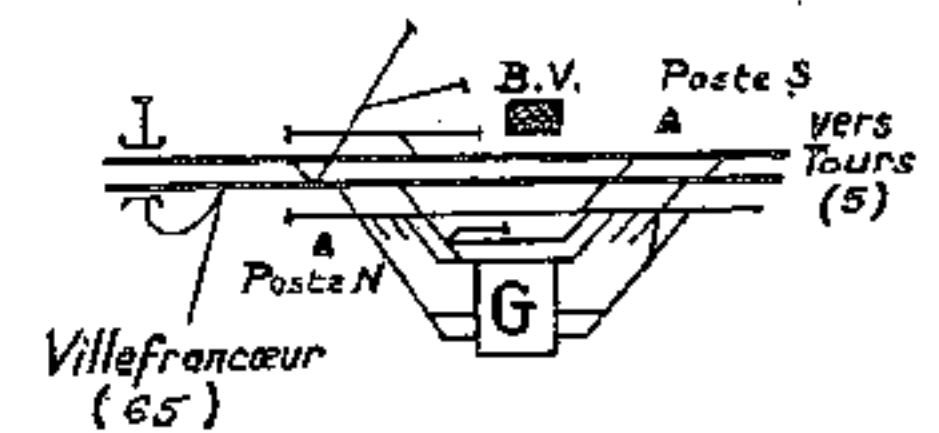

B.V.
Viaduc de Beaugency (210m)

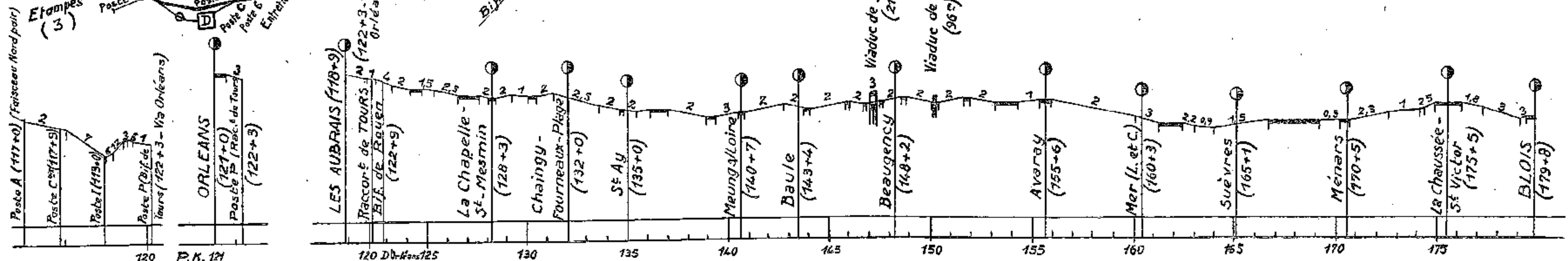

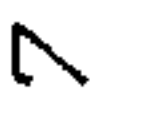

Abords de Port-de-Piles

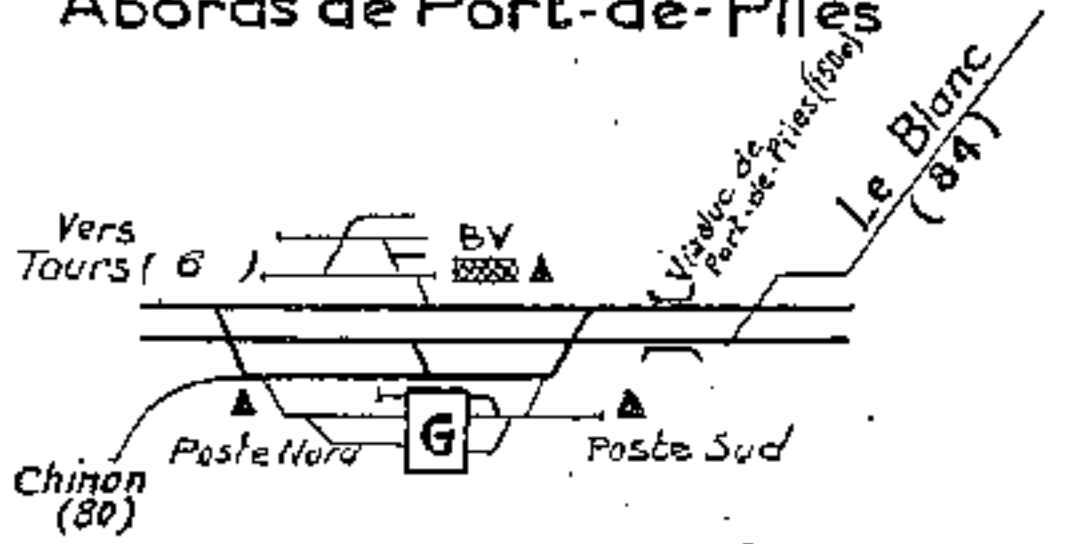

Abords de Châtellerault

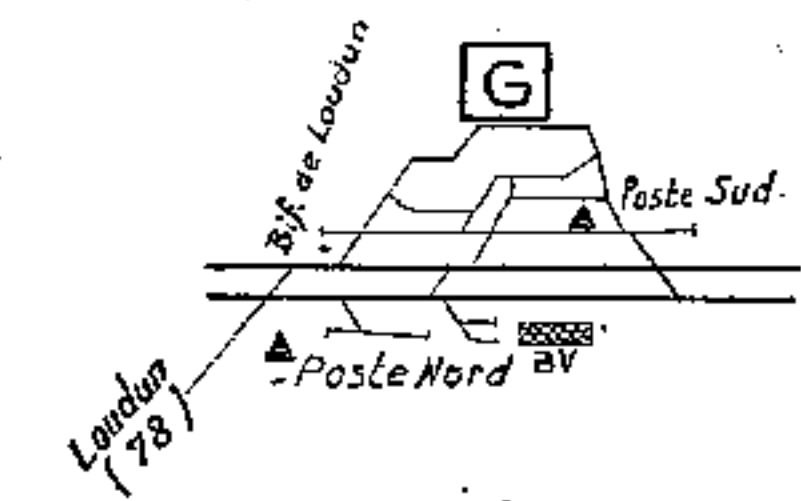

Ligne de Tours à Poitiers

Section de Port-de-Piles à Poitiers

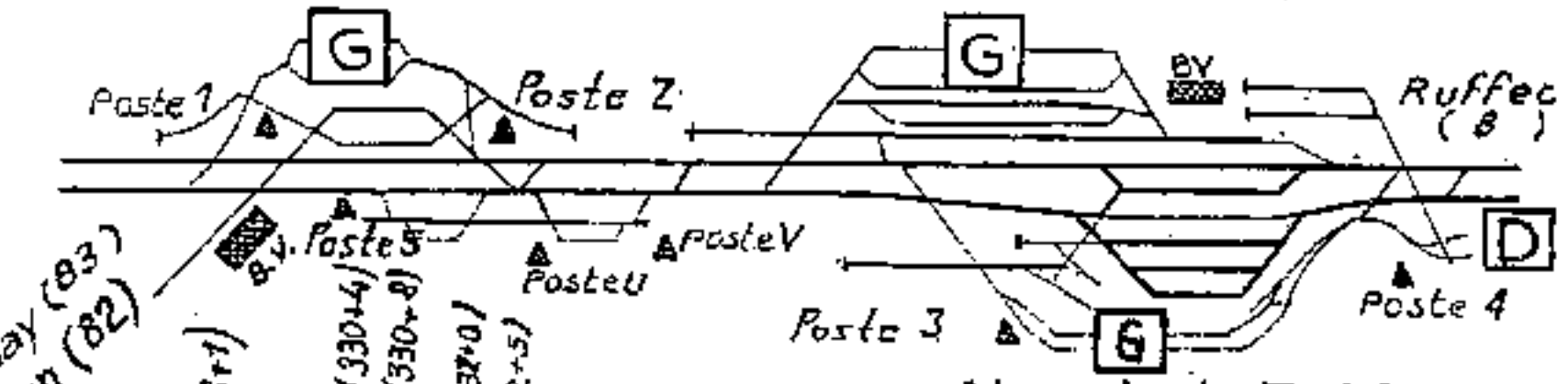

Abords de Poitiers Grand-Pont-Preuilly

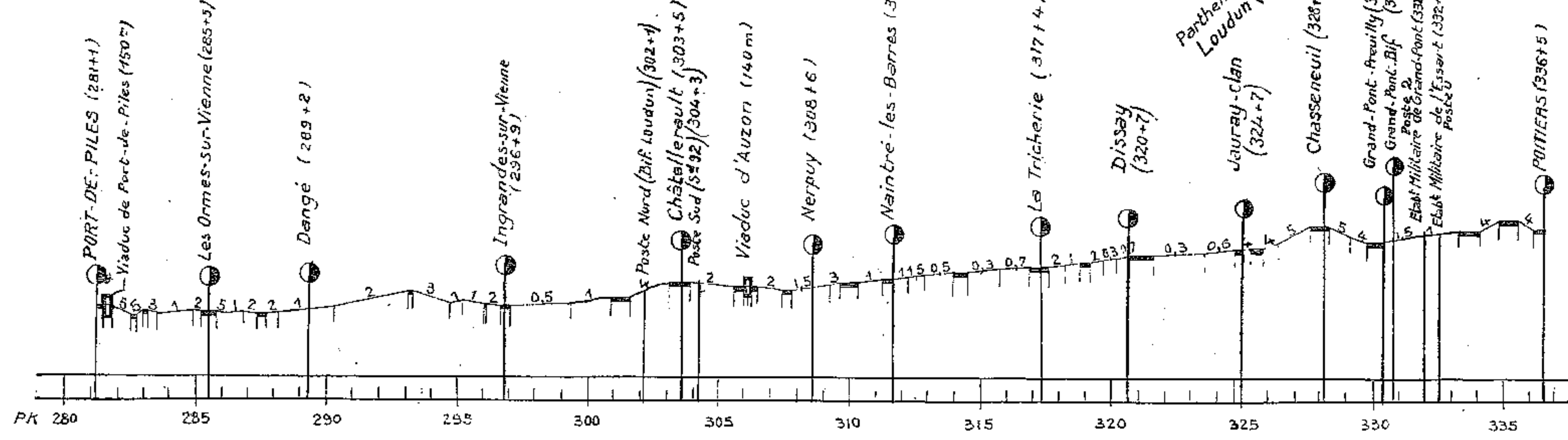

Abords de Tours - St Pierre-des-Corps (voir 201)

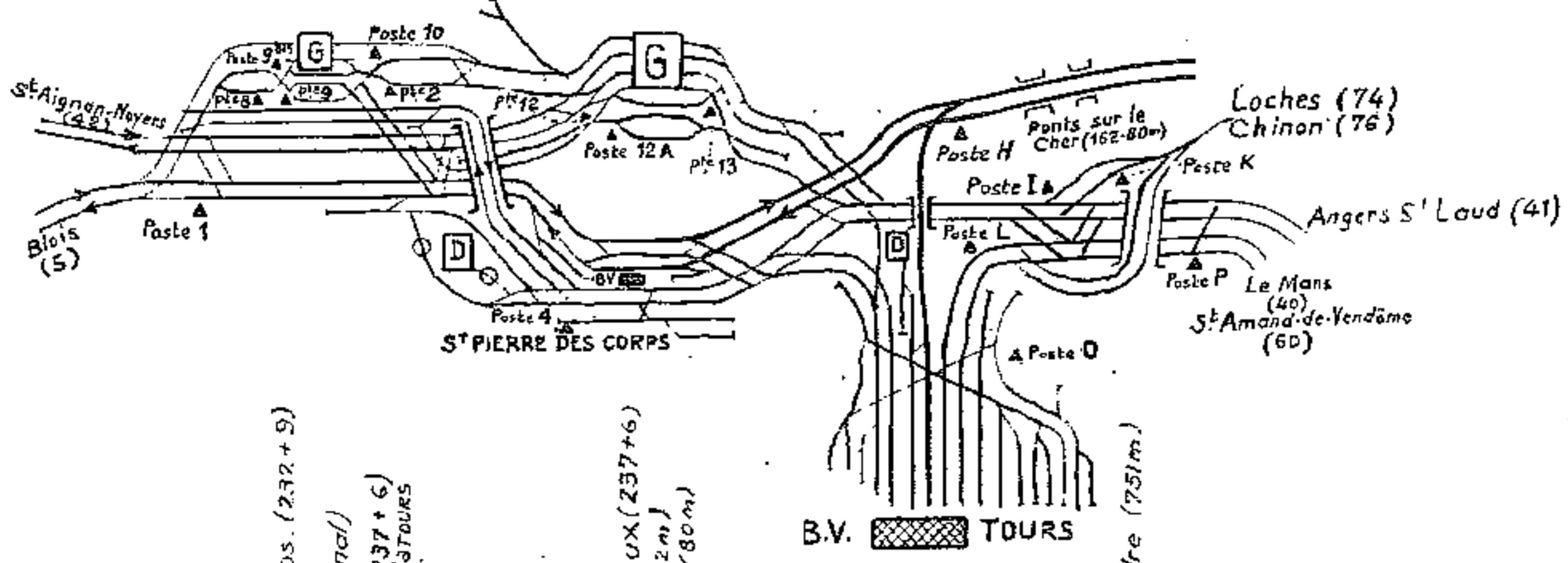

Ligne de Tours à Poitiers

Section de Tours St Pierre à Port-de-Piles

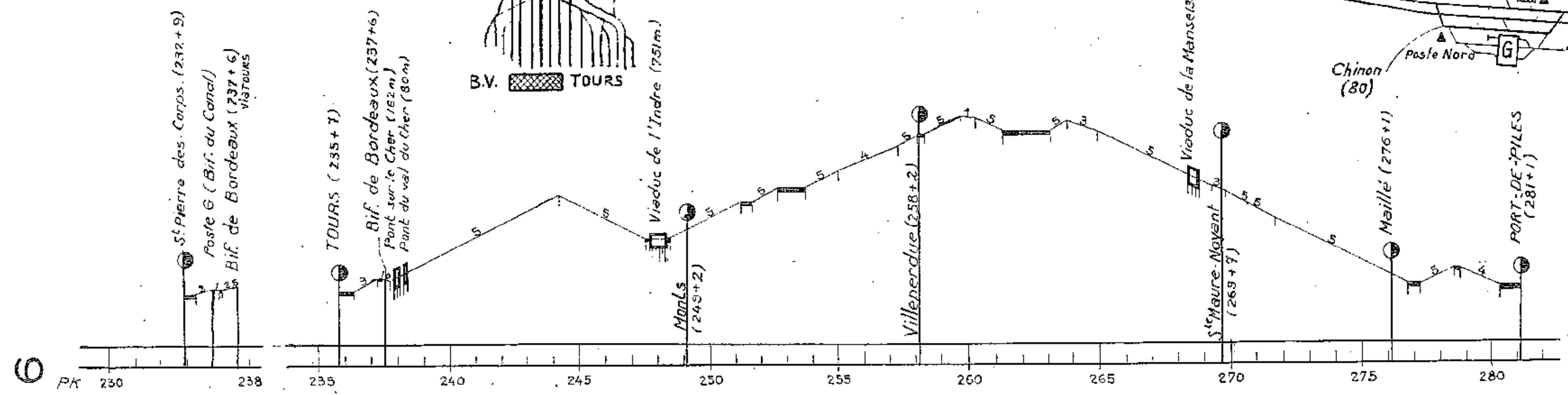
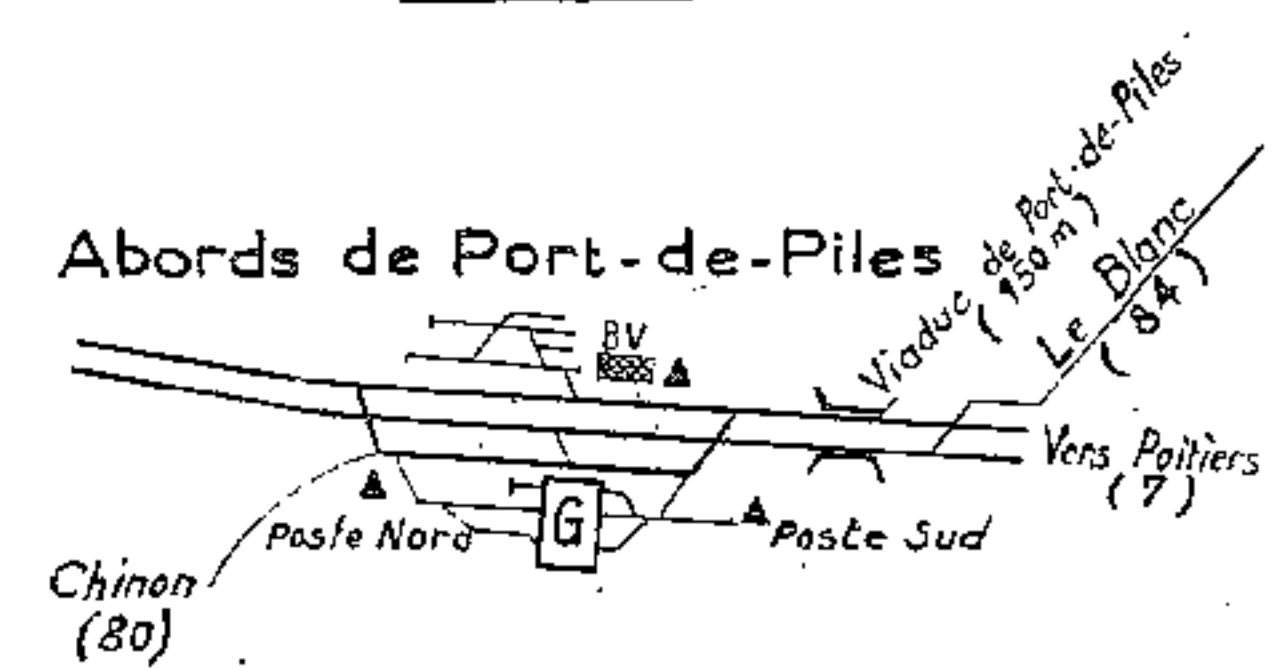

①

Ligne de Poitiers à Angoulême

Abords de Ruffec

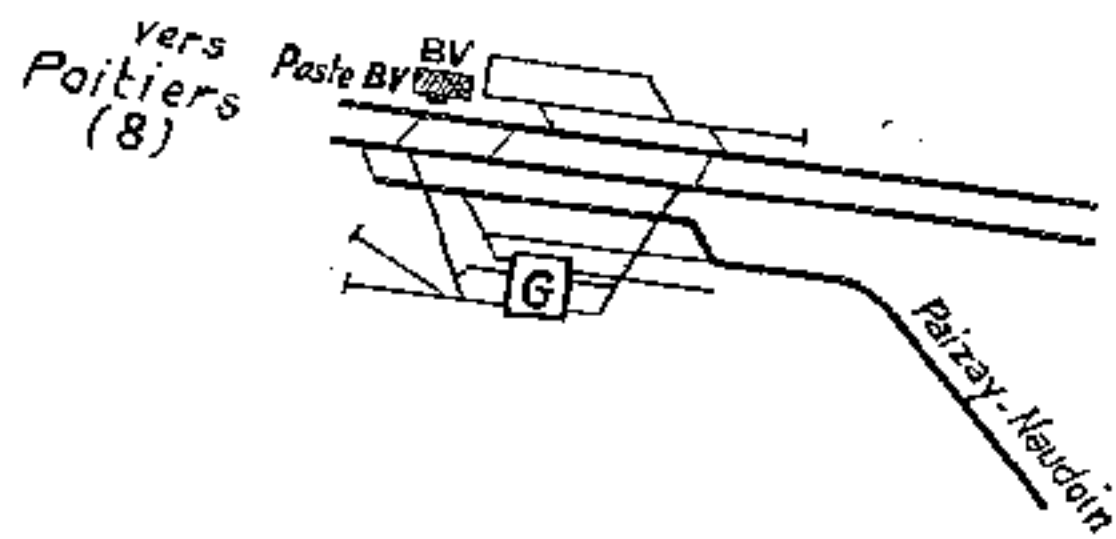

Section de Ruffec à Angoulême

Abords d'Angoulême

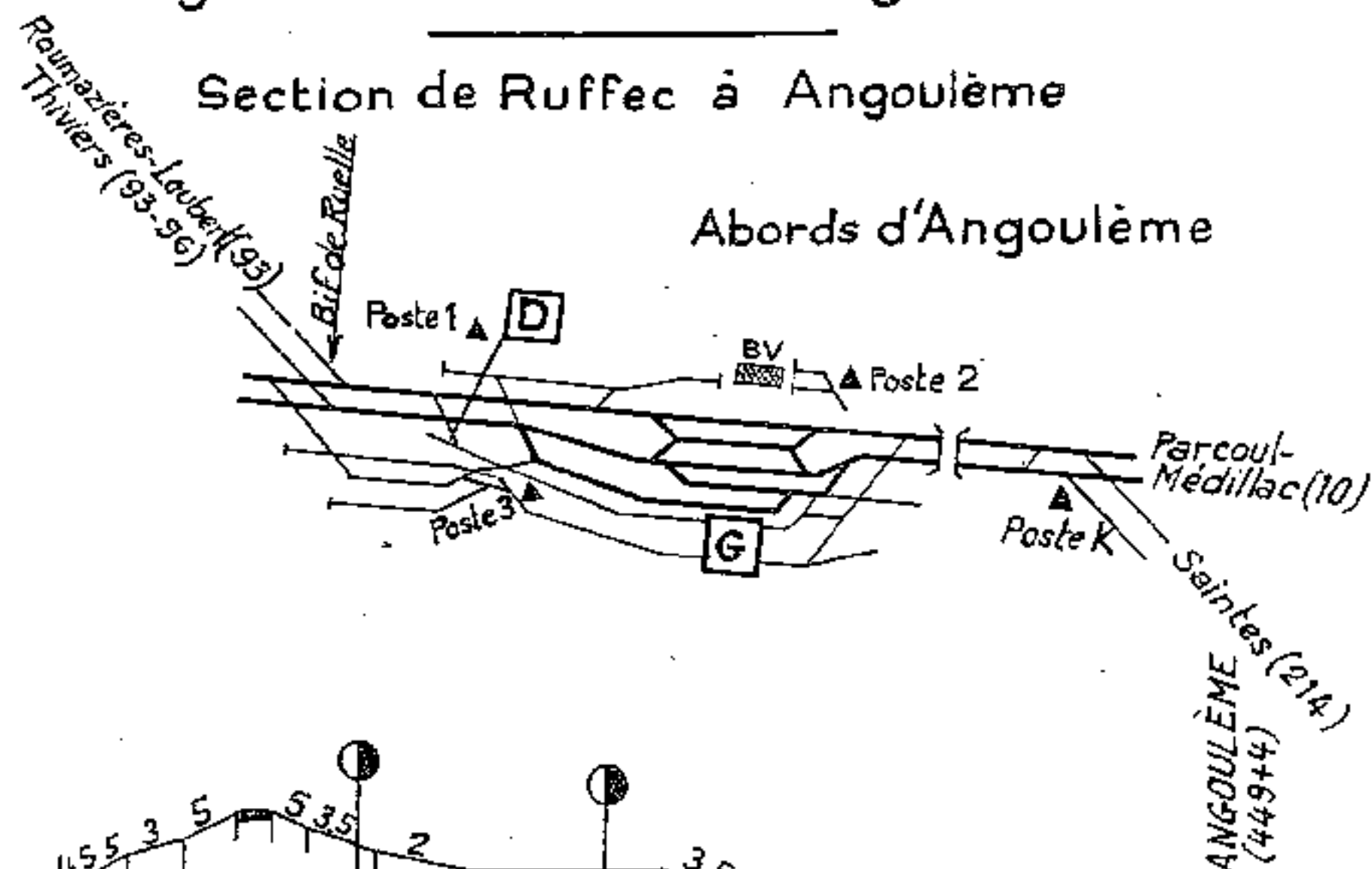

Ligne de Paizay-Naudoin à Ruffec

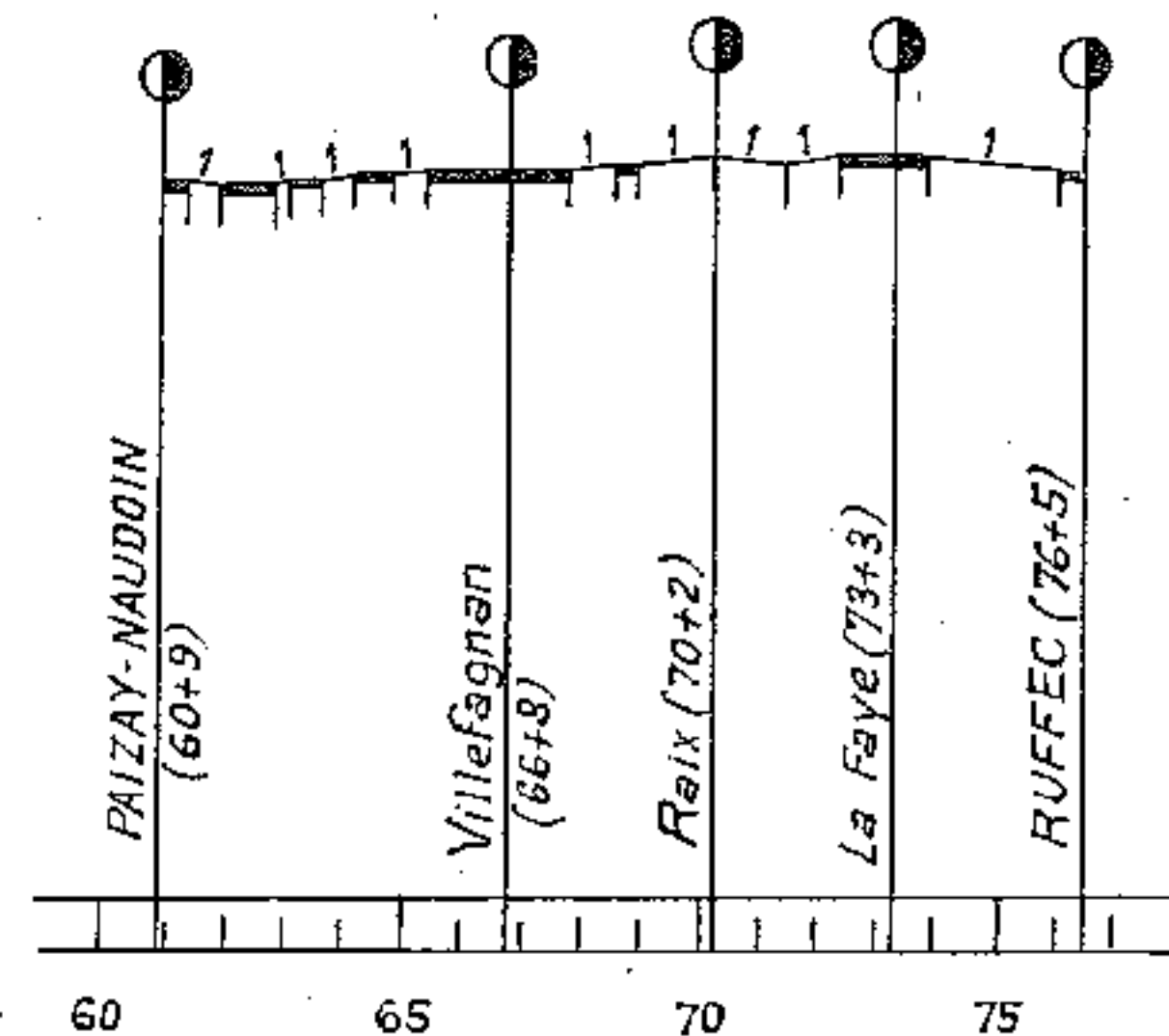
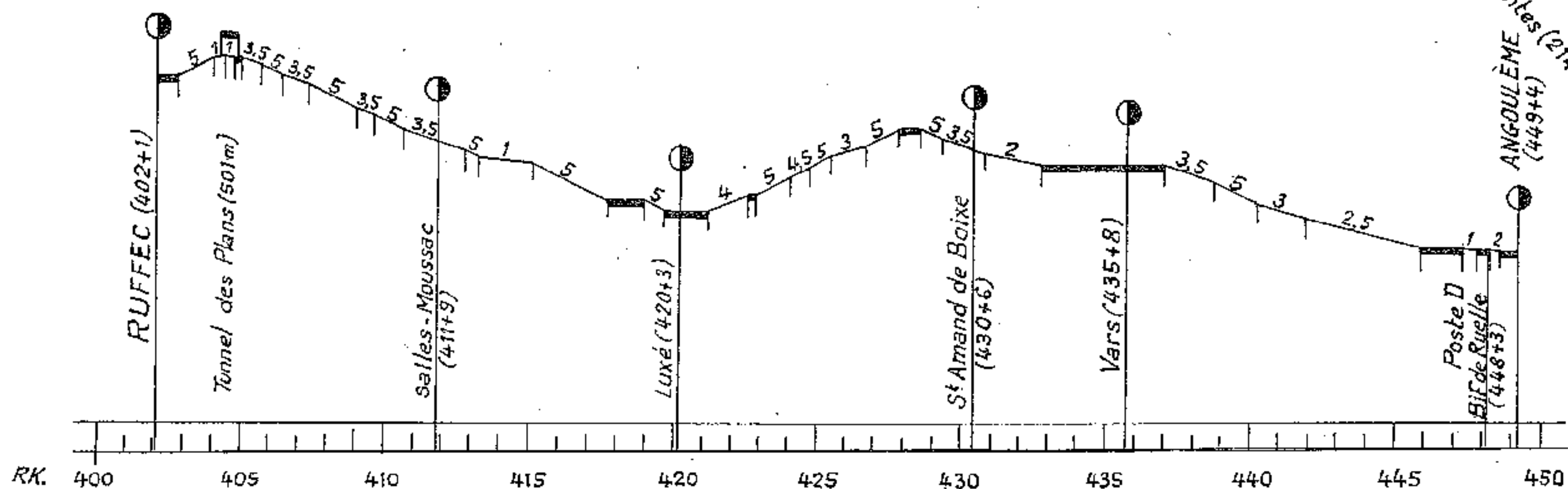

Abords de Poitiers - St. Benoit

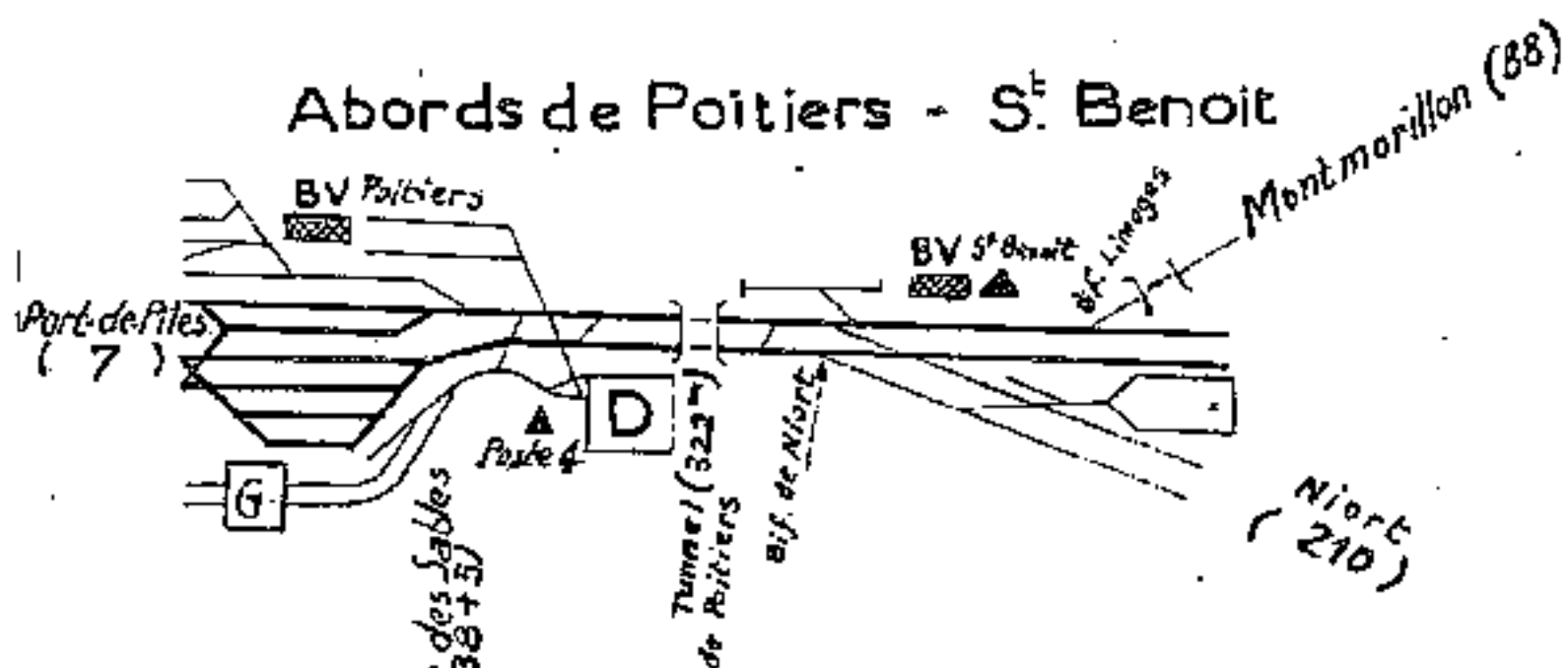

Abords de St. Saviol

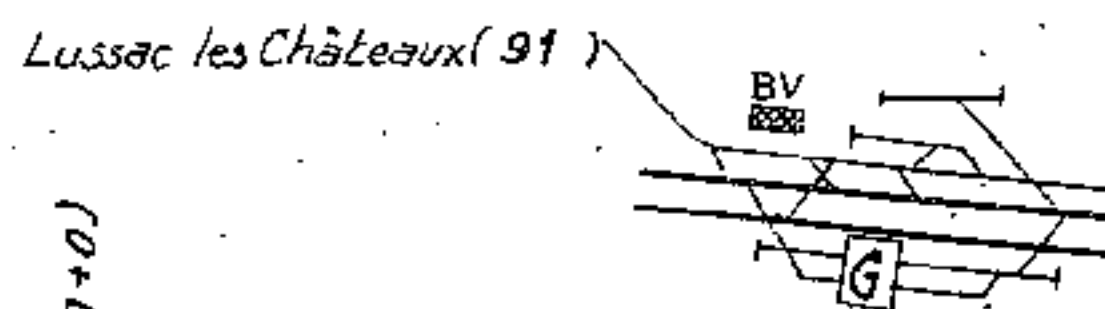

Ligne de Poitiers à Angoulême

Section de Poitiers à Ruffec

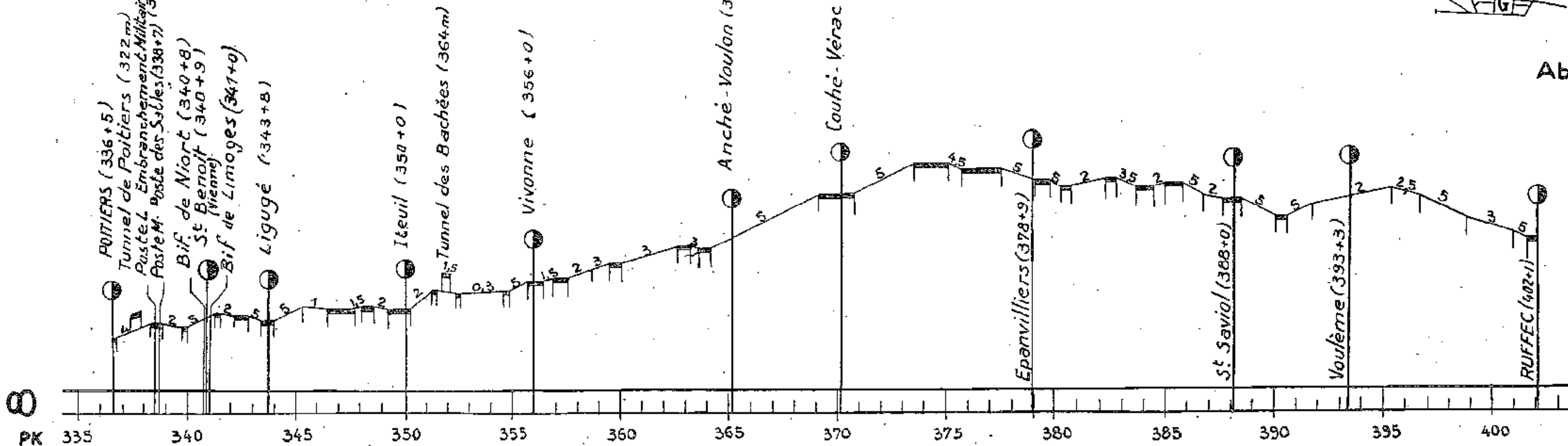
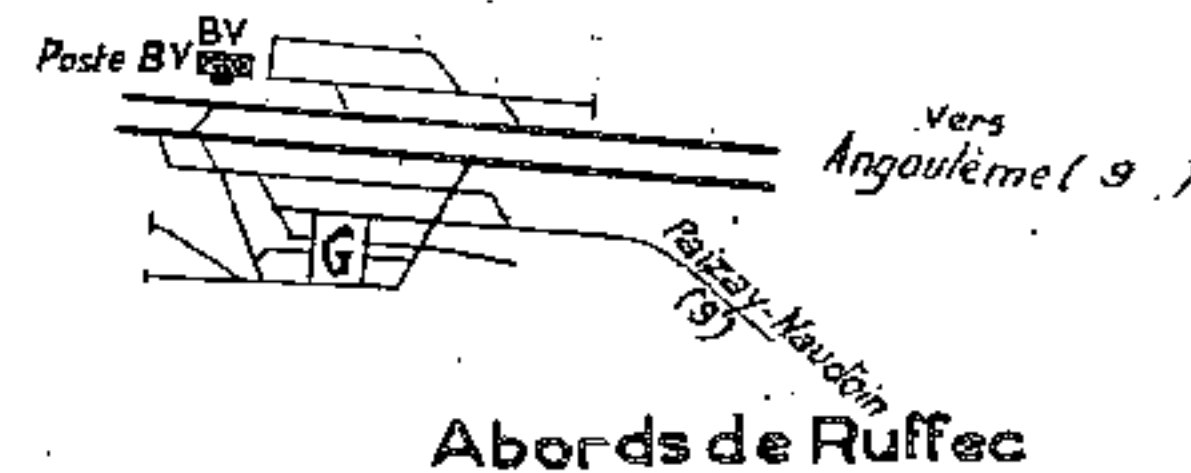

Abords de Parcou-Médillac

Ligne d'Angoulême à Bordeaux

Section de Parcou-Médillac à Libourne

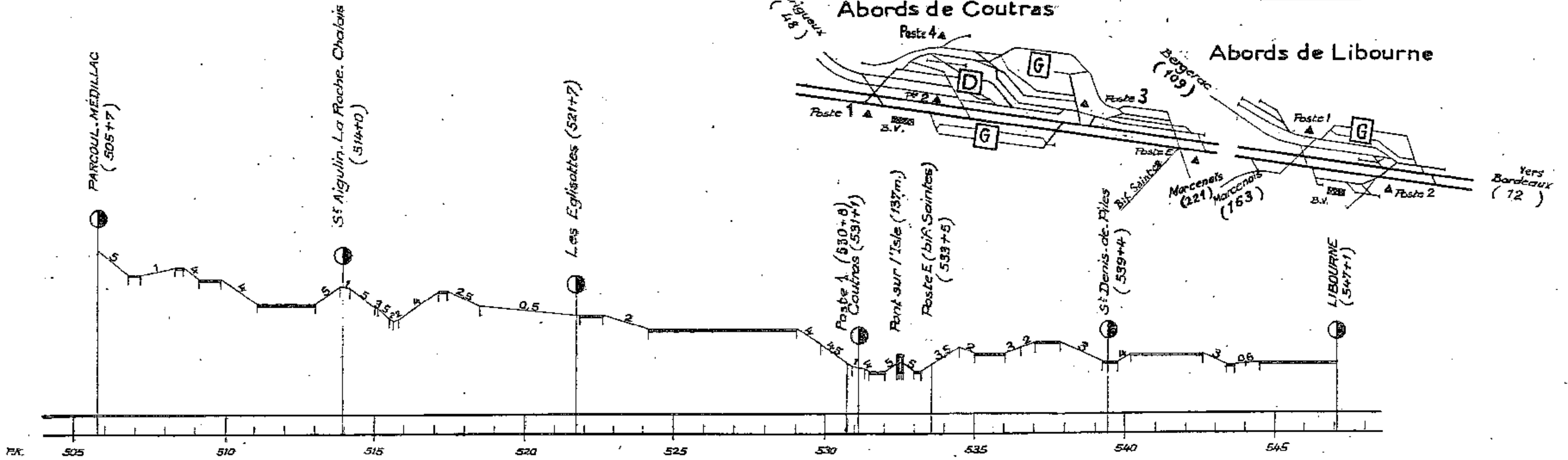

Abords d'Angoulême

Ligne d'Angoulême à Bordeaux

Ligne de St Aulaye à Parcou-Médillac

Section d'Angoulême à Parcou-Médillac

Abords de Parcou-Médillac

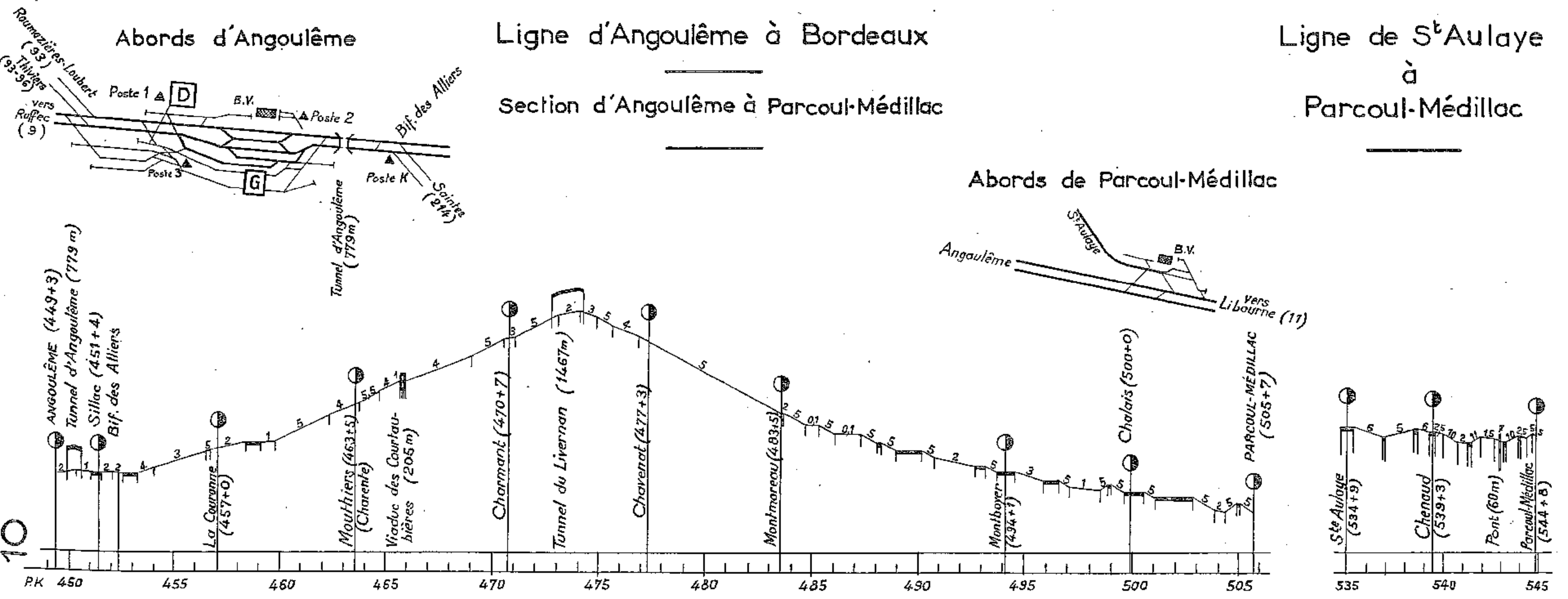

Abords de Bordeaux - S^t Jean (voir 203)

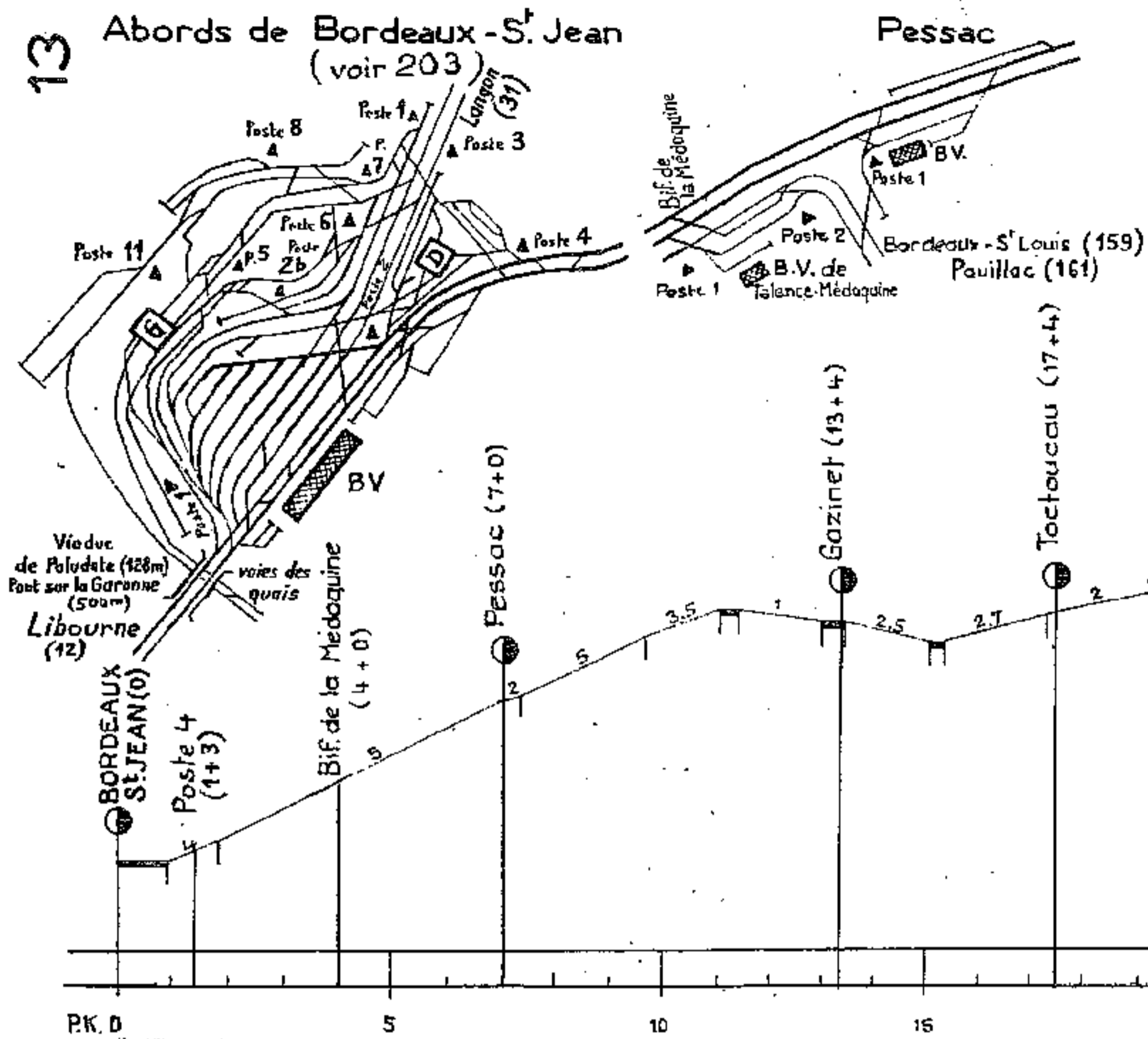

Ligne de Bordeaux - S^t Jean à Dax
Section de Bordeaux - S^t Jean à Lamothe

Abords de Lamothe

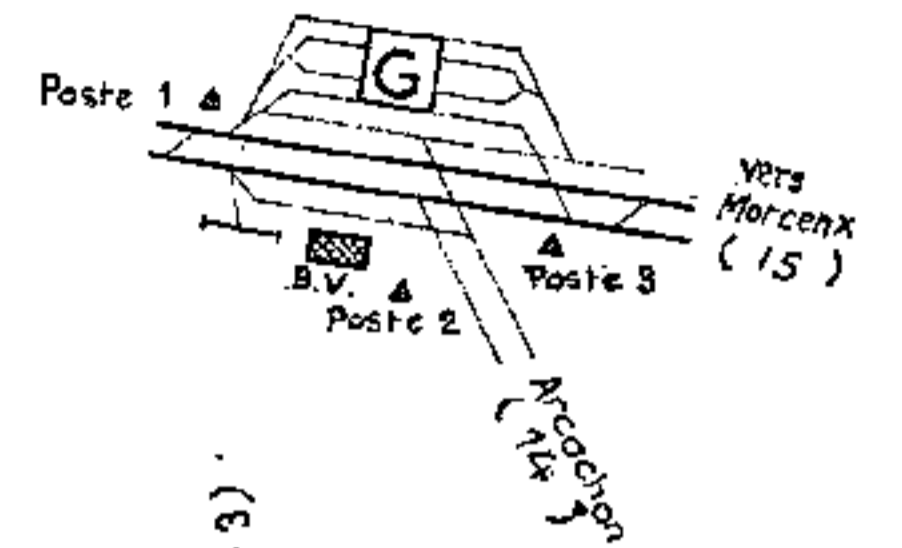

Abords de Libourne

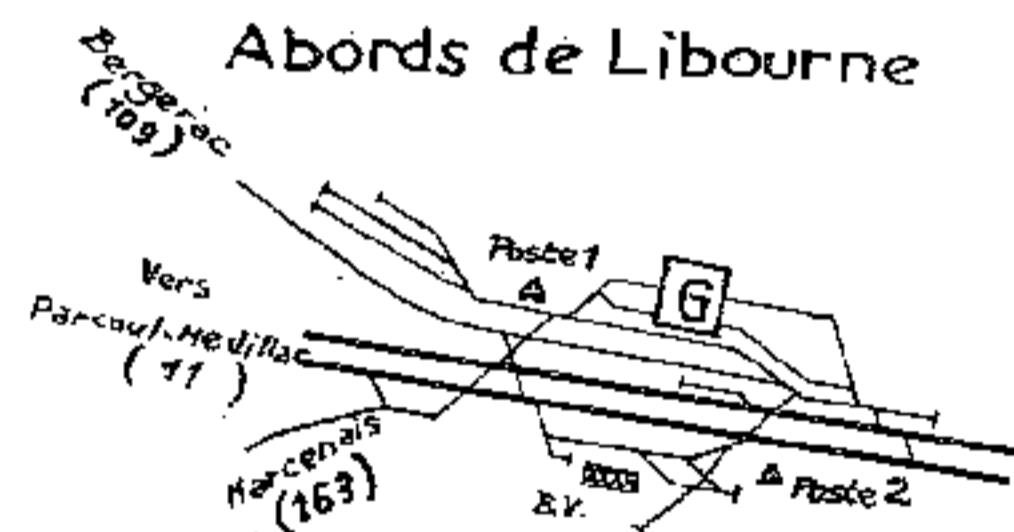

Ligne d'Angoulême à Bordeaux
Section de Libourne à Bordeaux

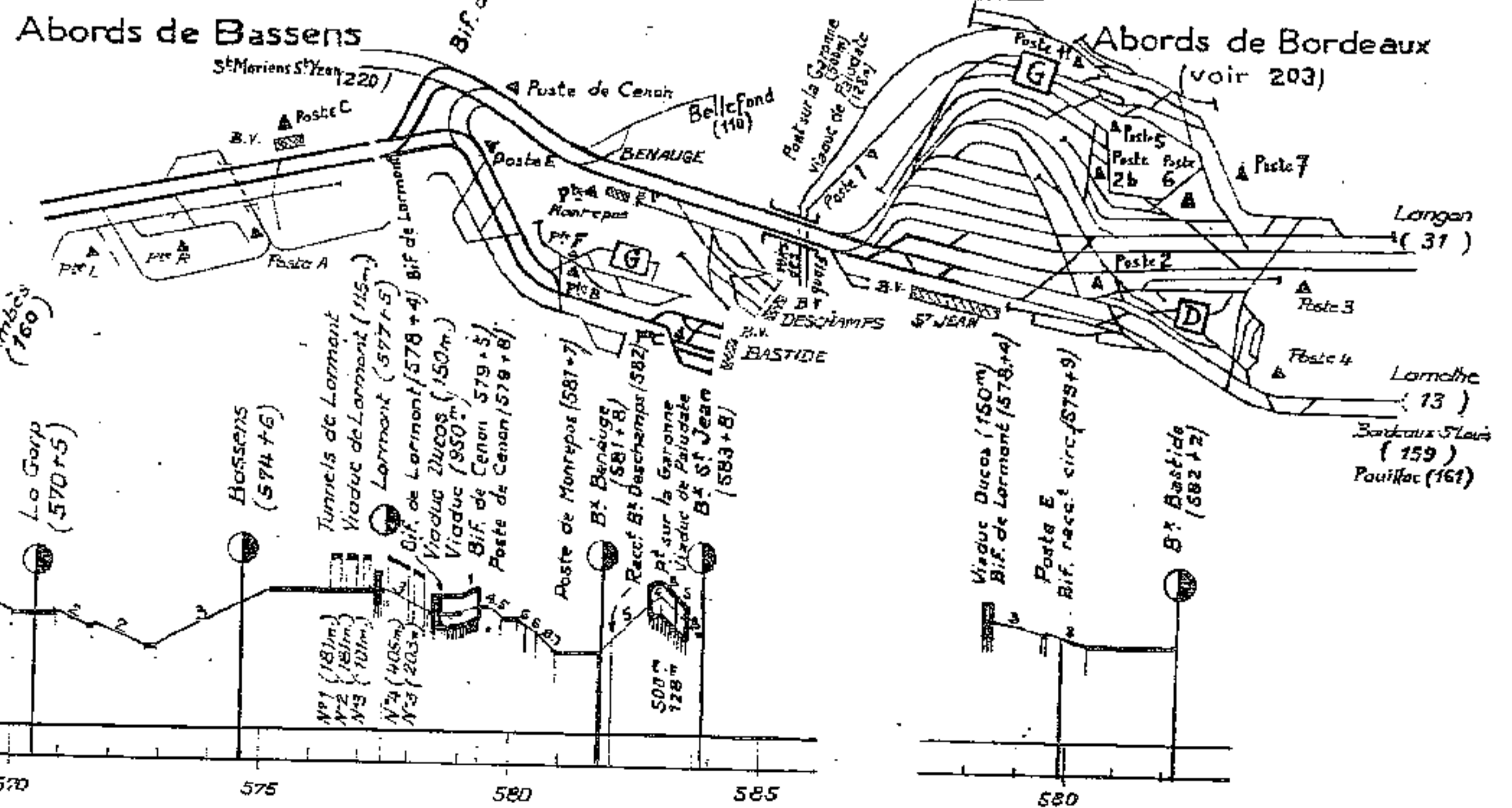

Abords de Lamothe

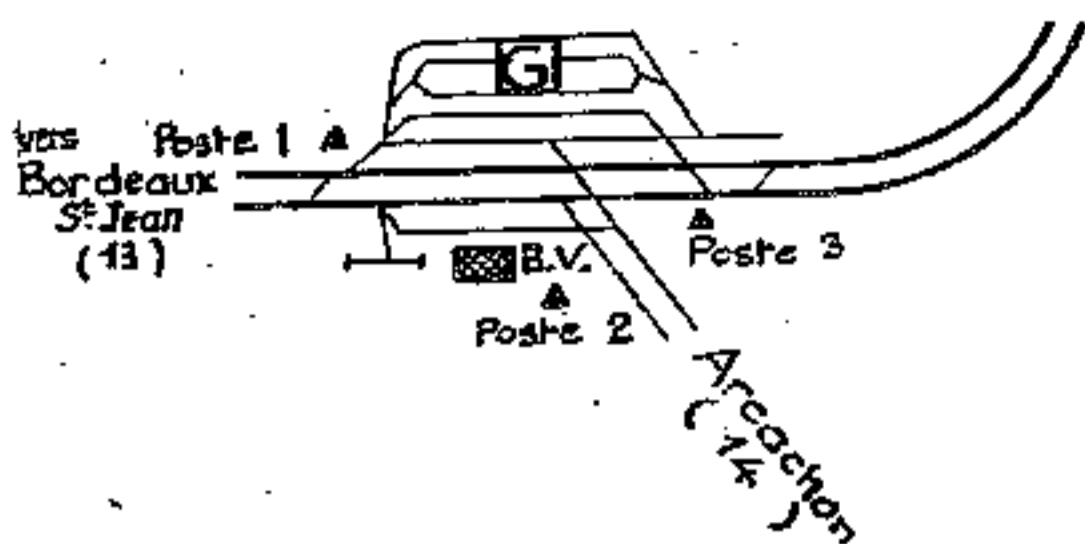

Ligne de Bordeaux-St. Jean à Dax
Section de Lamothe à Morcenx

Abords de Morcenx

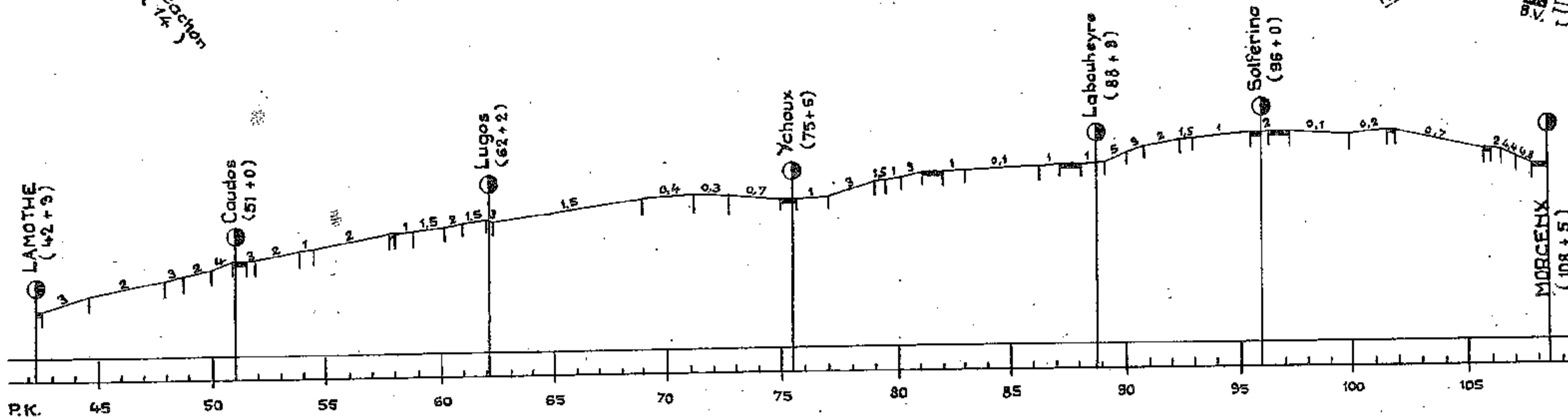

Abords de Lamothe

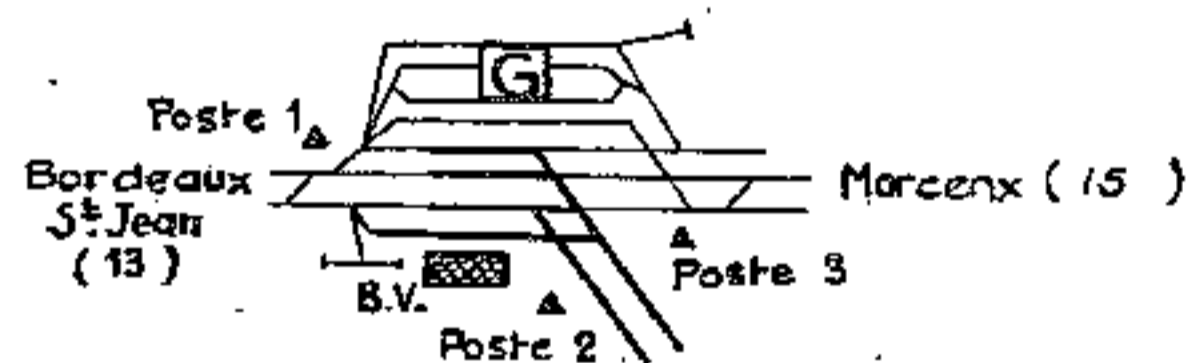

Ligne de Lamothe à Arcachon

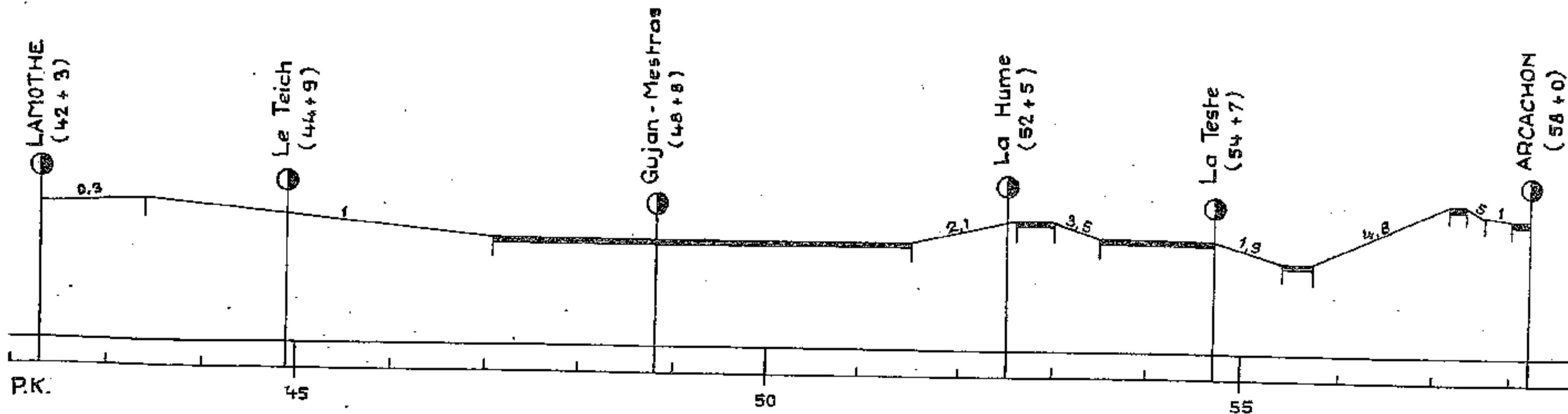

Abords de Dax

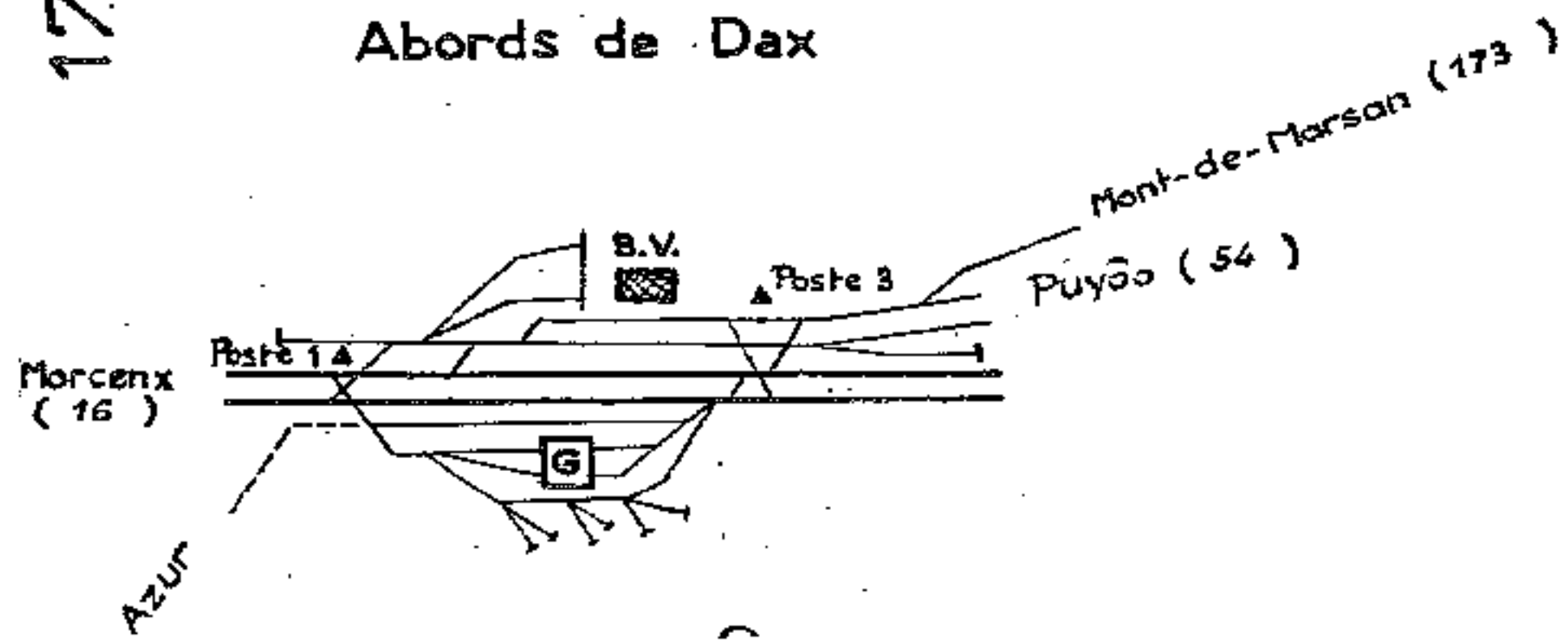

Ligne de Dax à Hendaye

Section de Dax à Bayonne

Abords de Bayonne

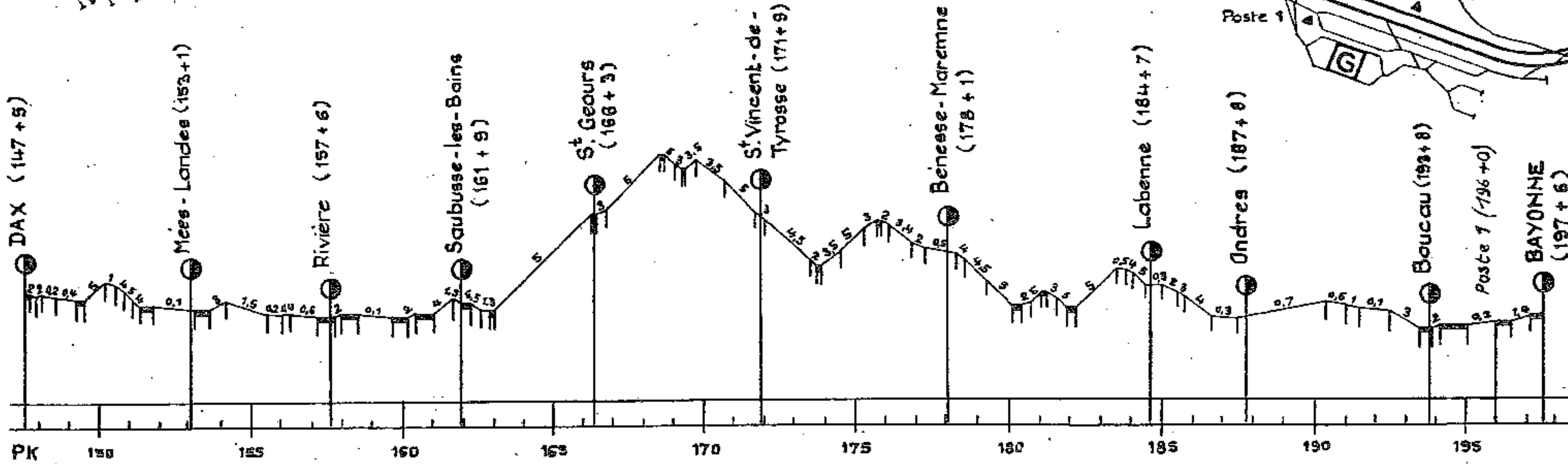
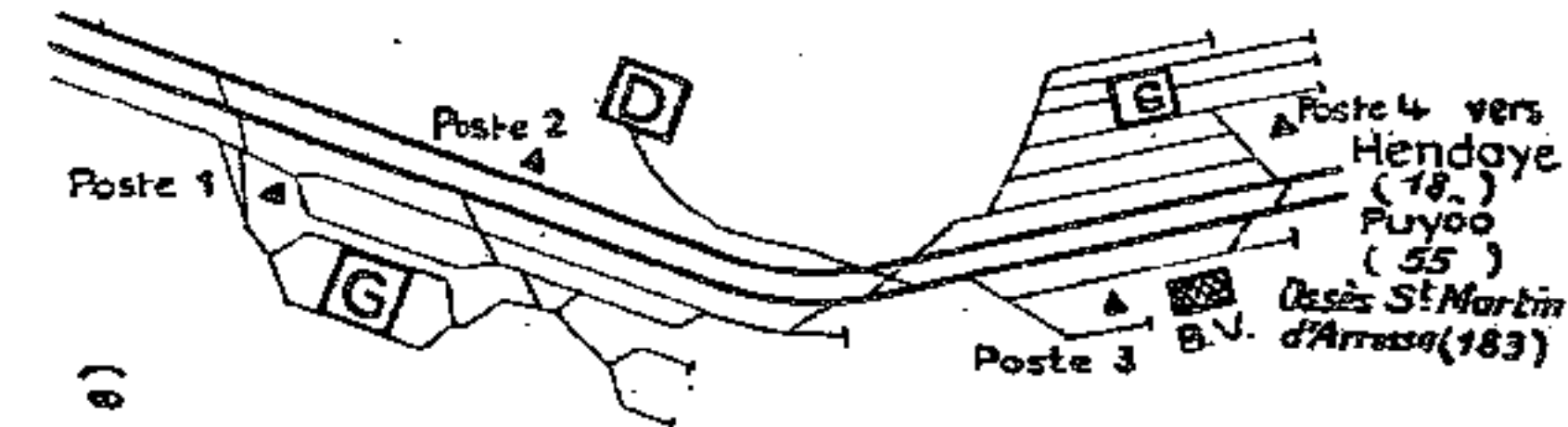

Abords de Morcenx

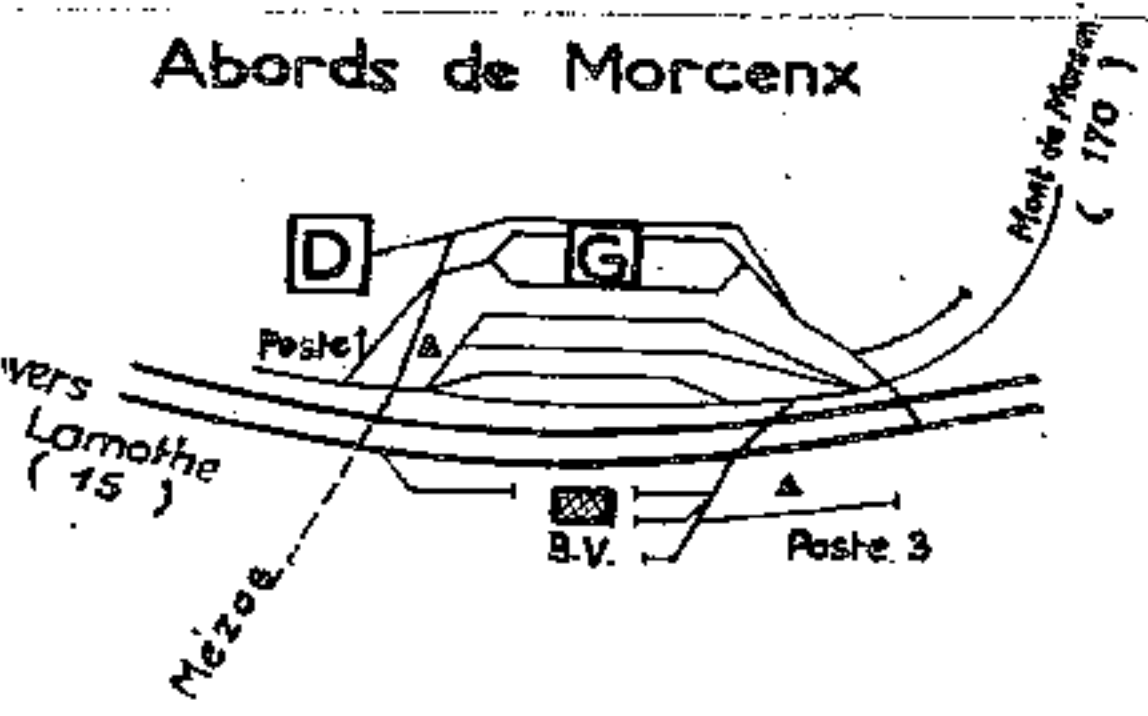

Ligne de Bordeaux-St-Jean à Dax

Section de Morcenx à Dax

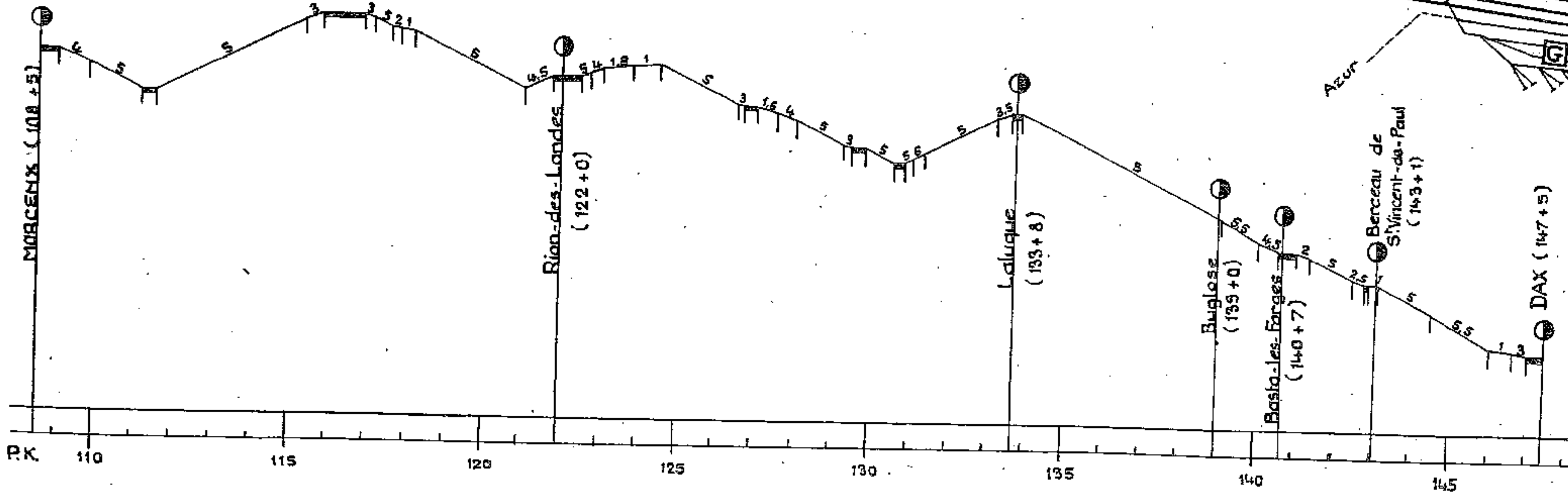
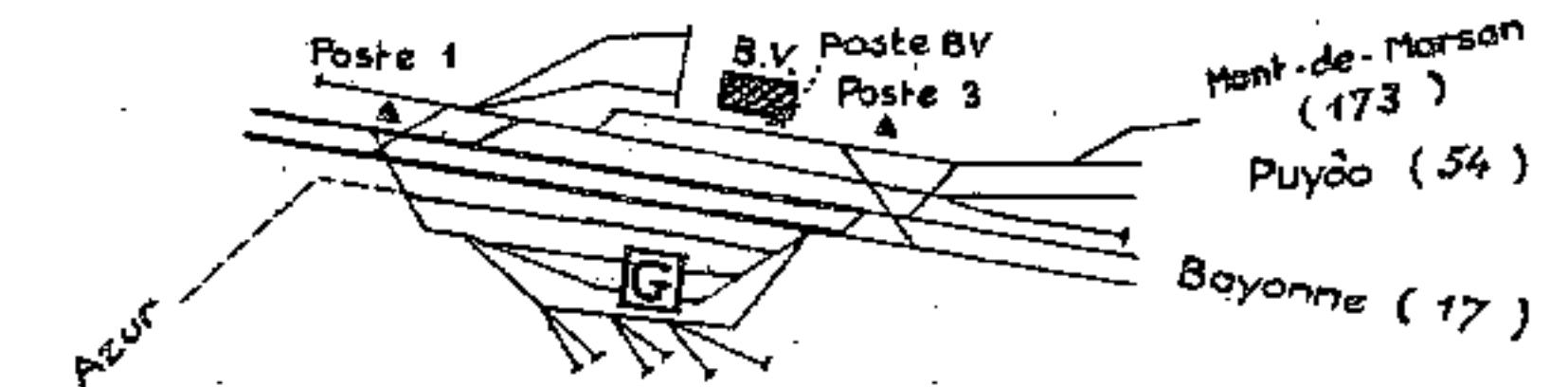

Abords de Dax

Abords de Valenton

Abords de Juvisy (voir 199)

Ligne de Valenton à Juvisy

et raccordement sur Paris Orléans

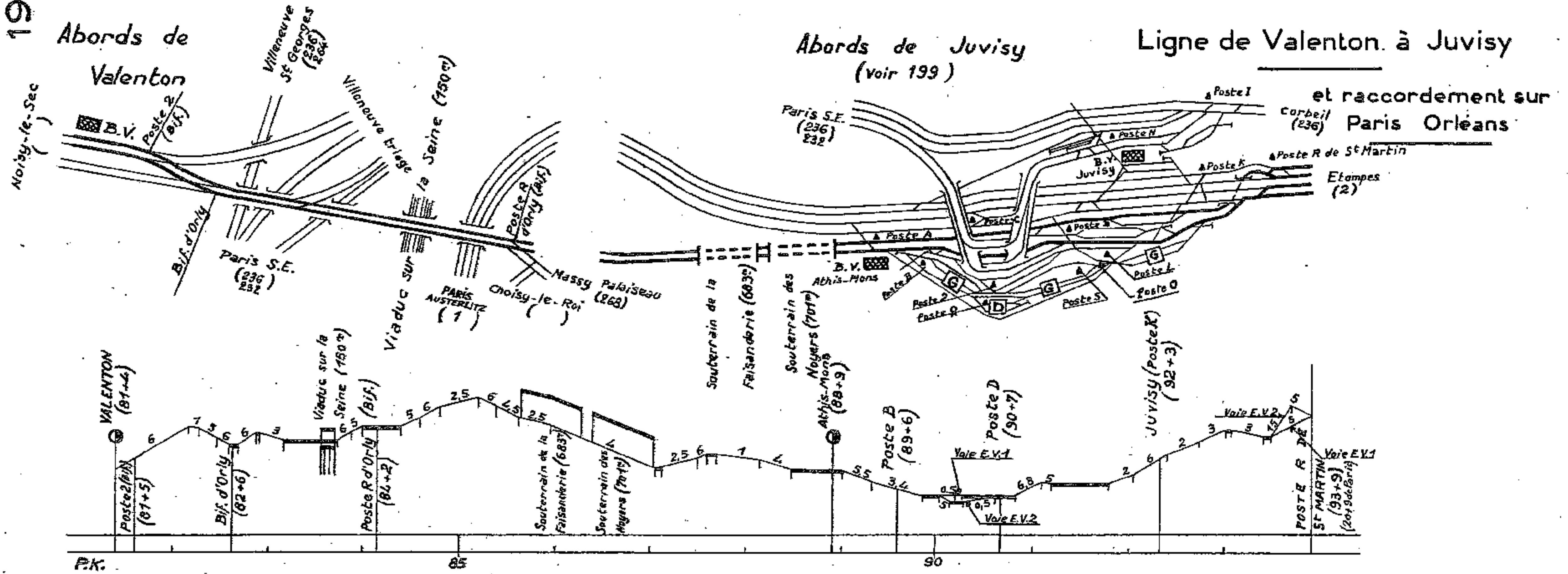

Abords de Bayonne

Abords de Biarritz-la-Négresse

Ligne de Dax à Hendaye

Section de Bayonne à Hendaye

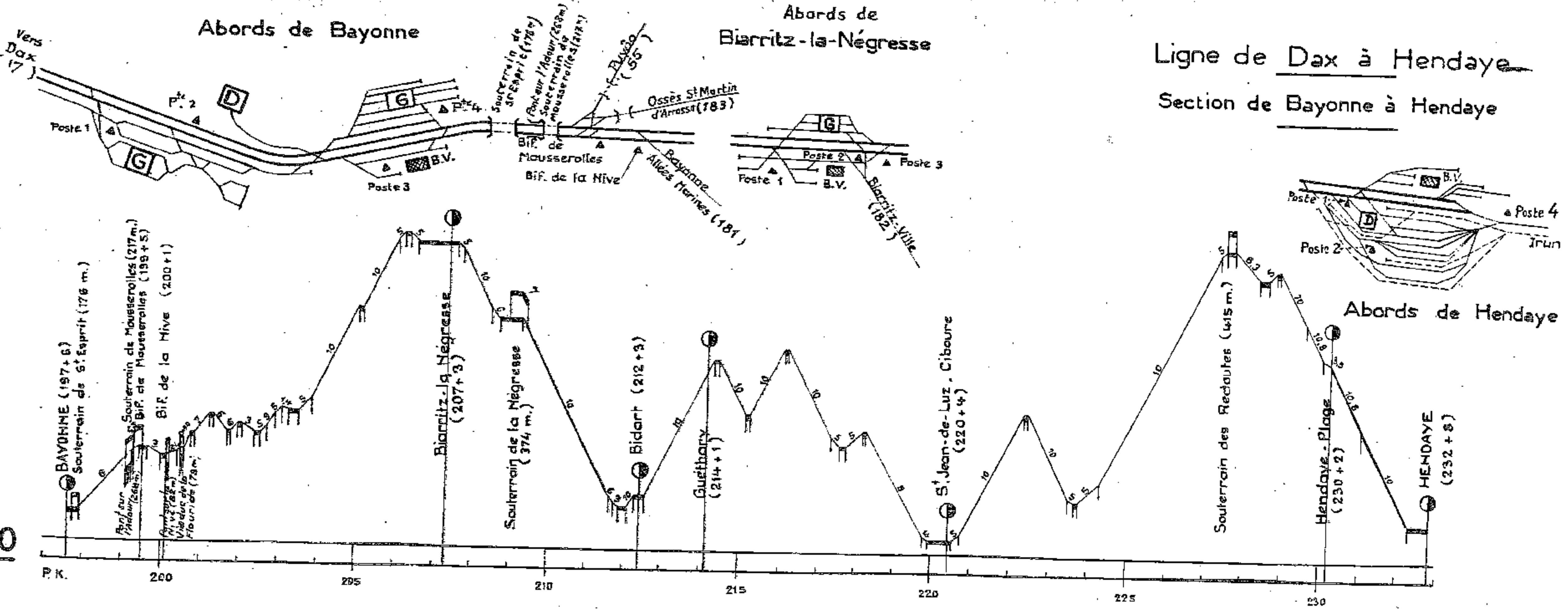

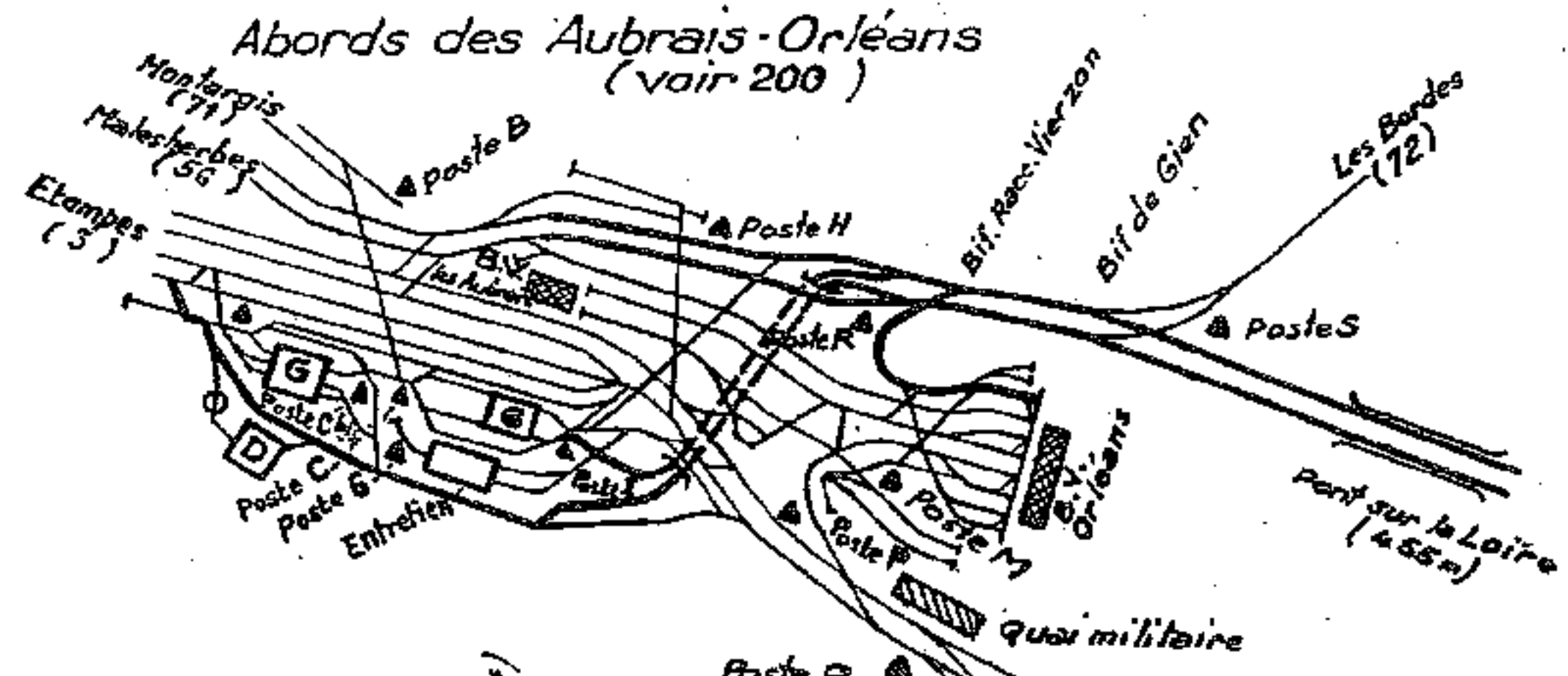

Ligne des Aubrais-Orléans à Vierzon

Section des Aubrais Orléans à Lamotte Beuvron

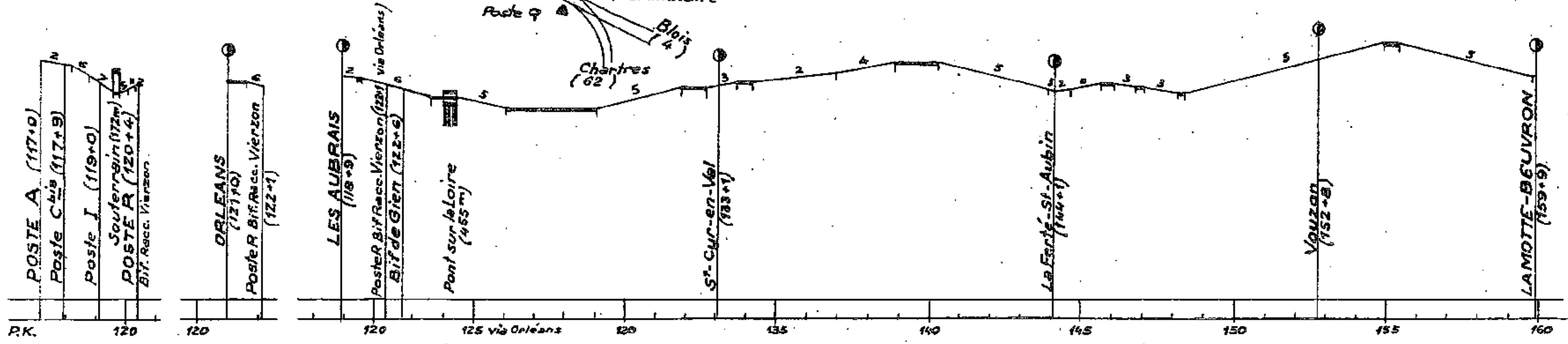

Ligne de Choisy-le-roi à Orly

Abords de Choisy-le-Roi

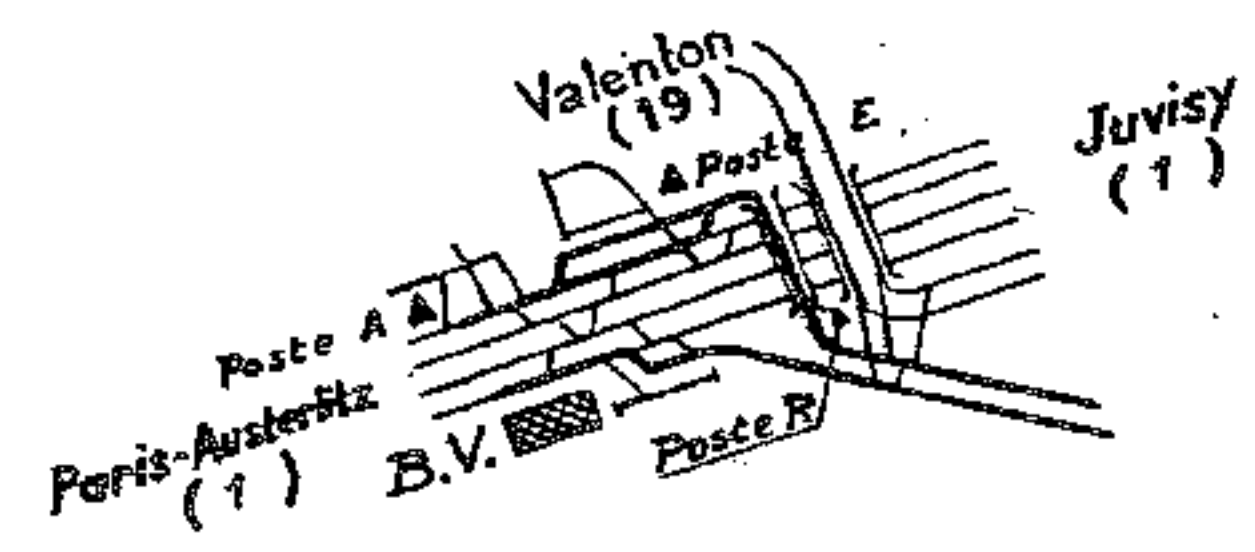

Abords d'Orly

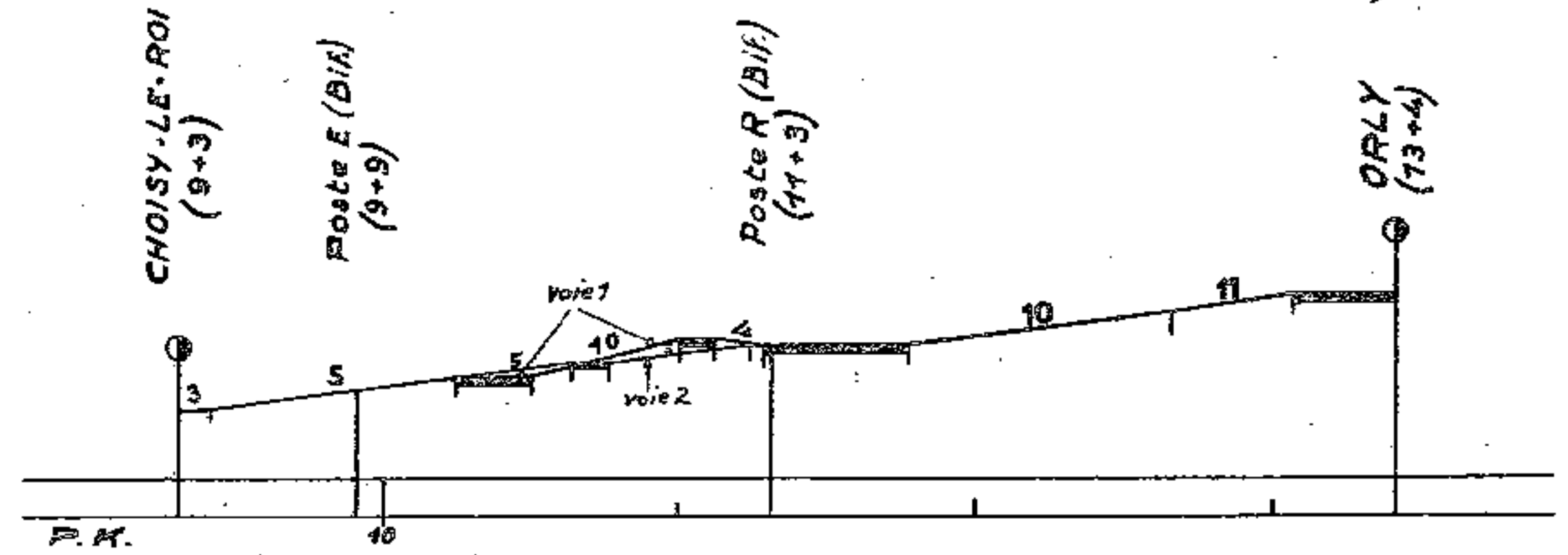
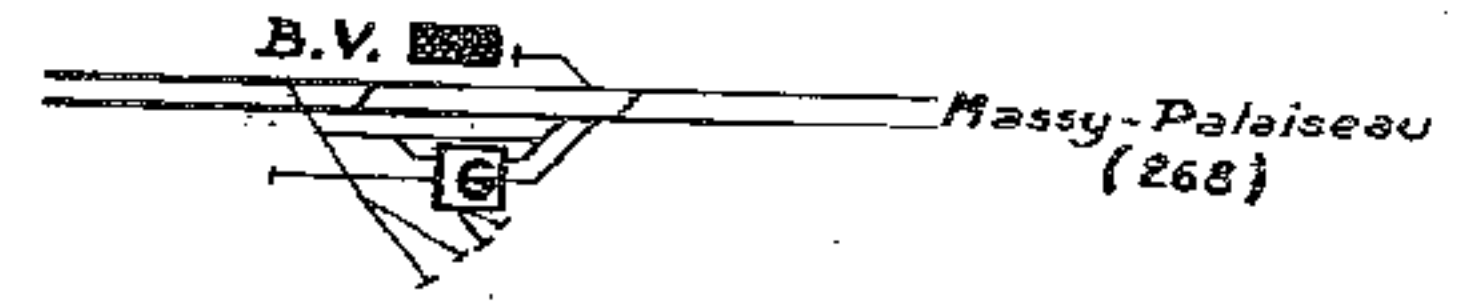

Ligne de Vierzon à Châteauroux

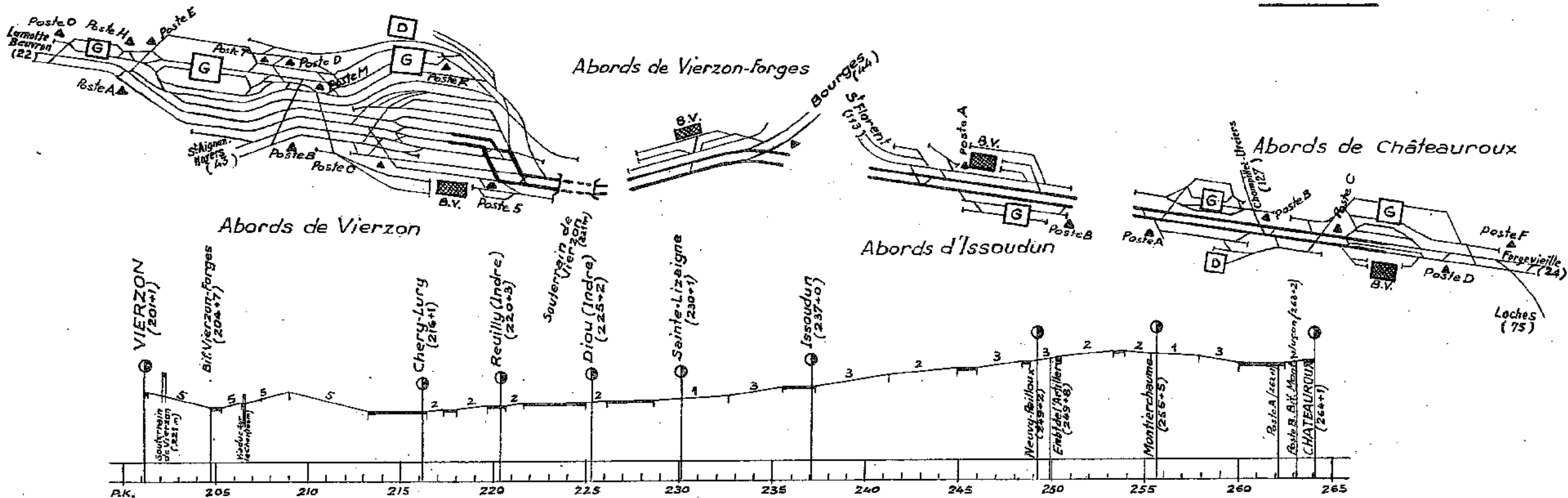

Ligne d'Orléans à Vierzon

Section de Lamotte-Beuvron à Vierzon

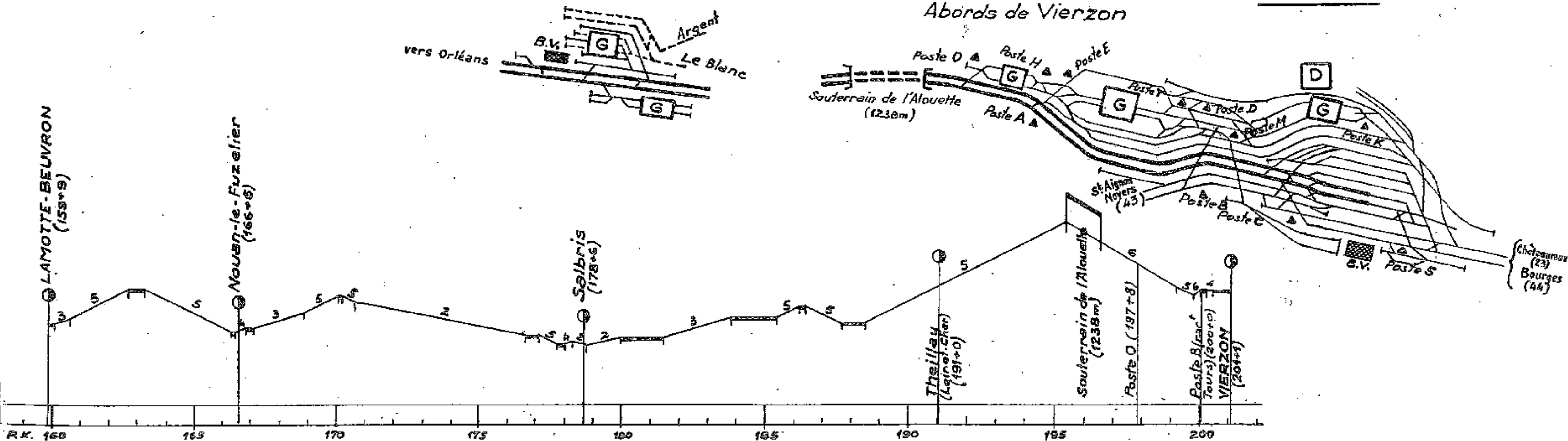

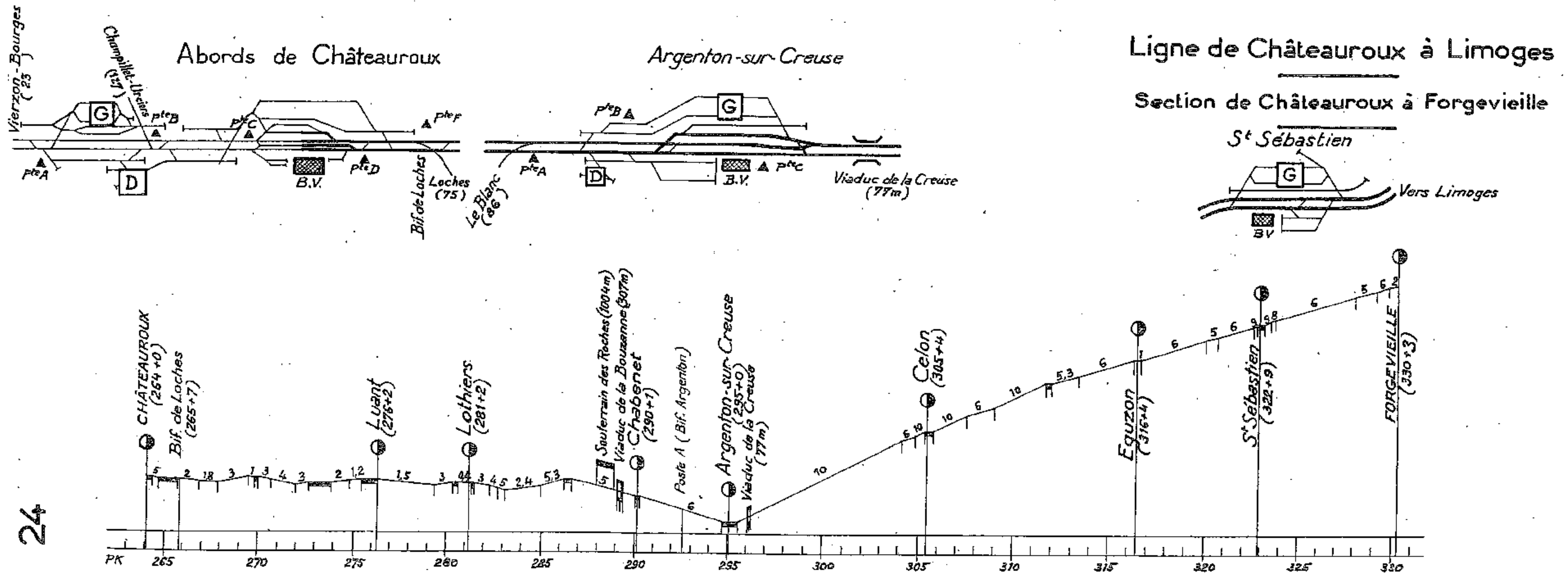
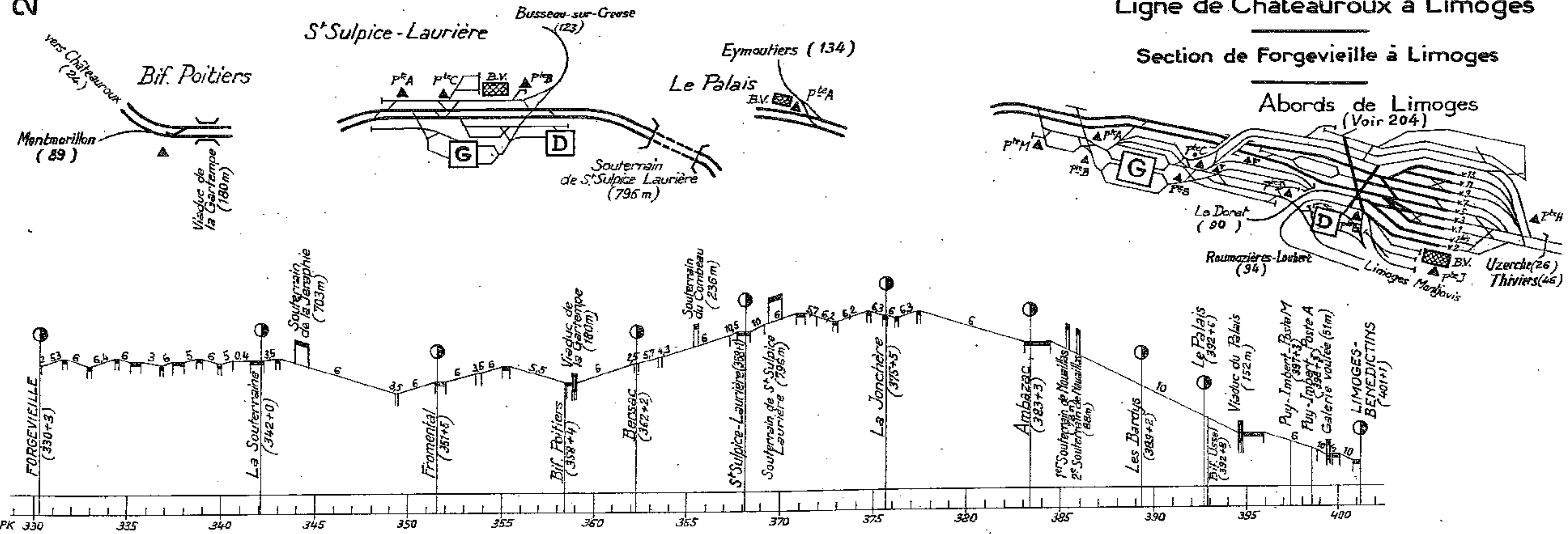

27 Abords d'Uzerche

Ligne de Limoges à Brive

Section d'Uzerche à Brive

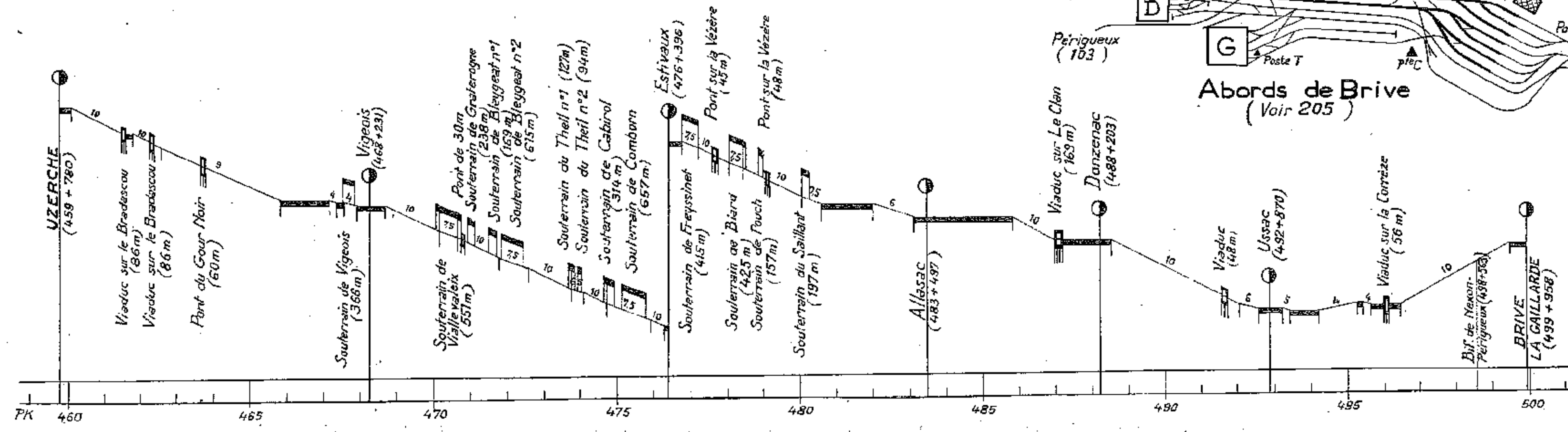
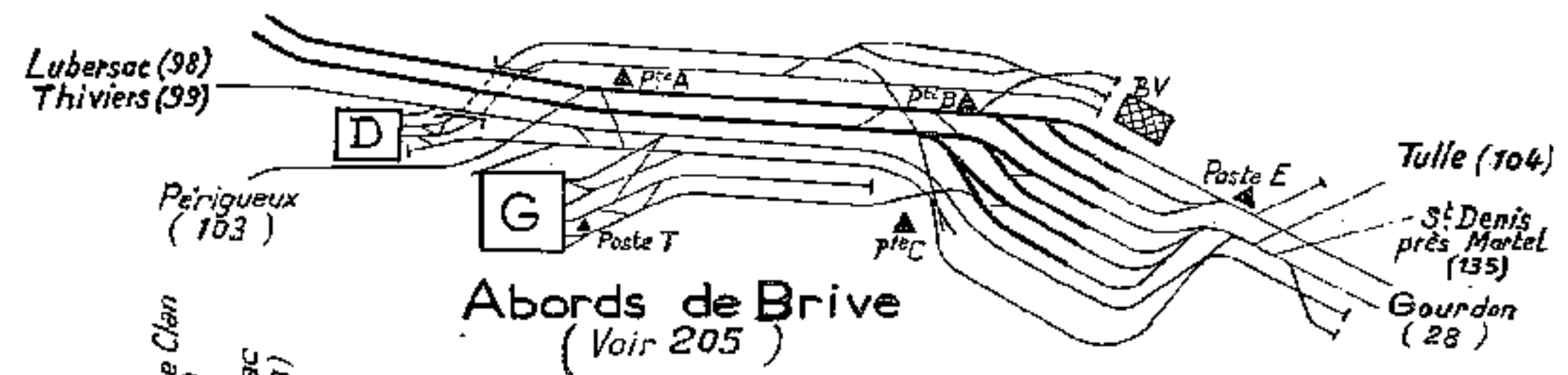
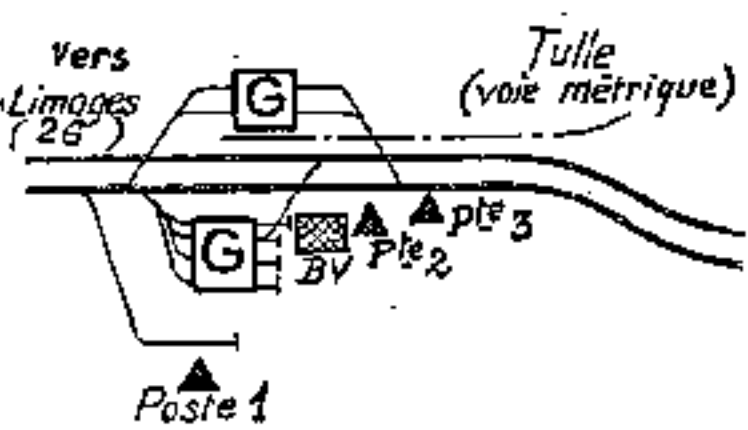

Abords de Limoges (voir 204)

Ligne de Limoges à Brive

Section de Limoges à Uzerche

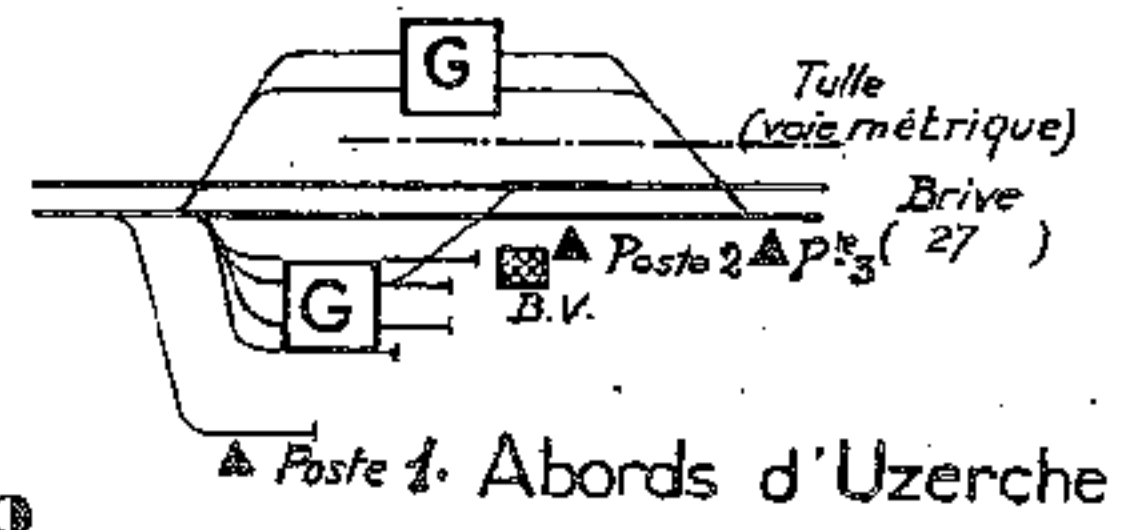
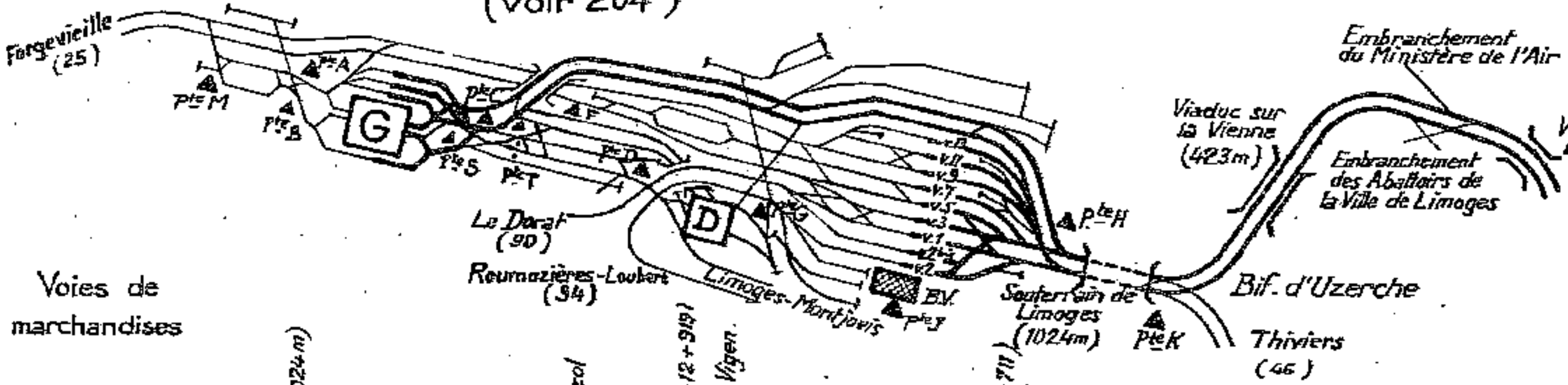

Voies de marchandises

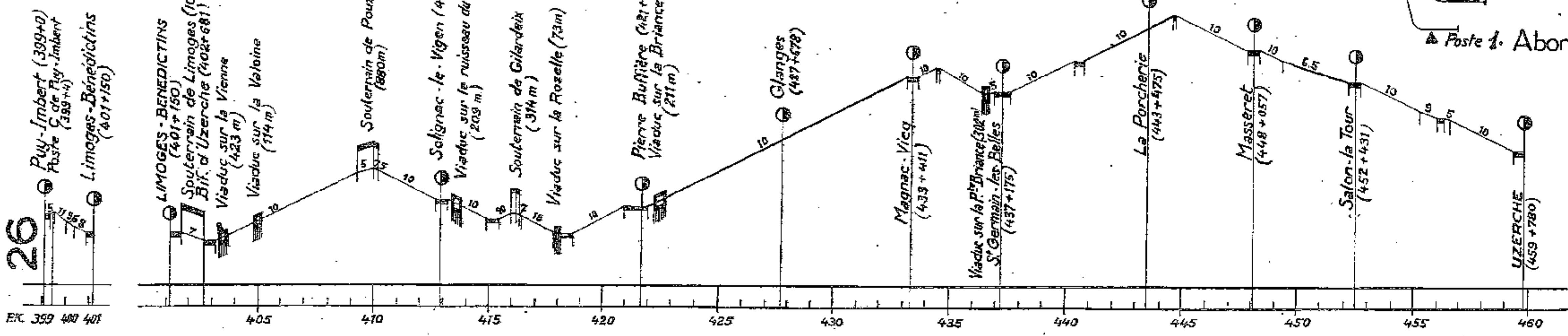

Abords de Gourdon

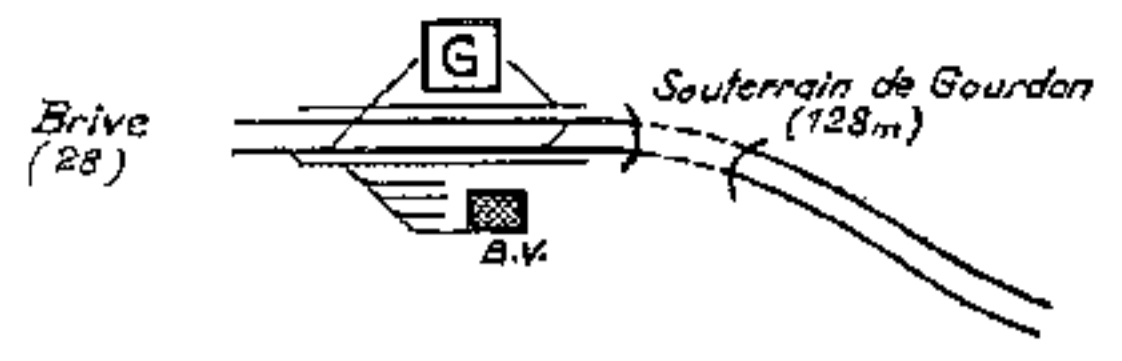

Ligne de Brive à Montauban

Section de Gourdon à Cahors

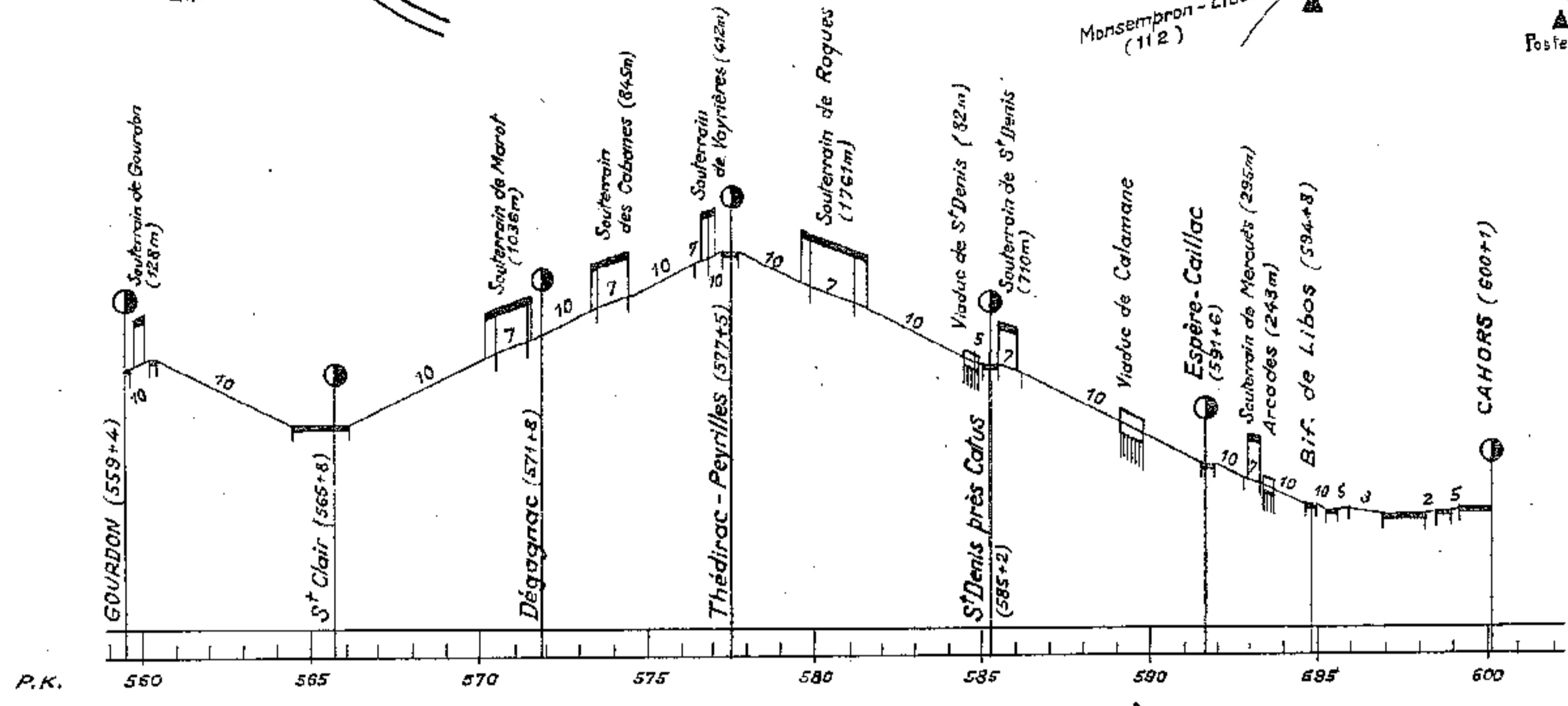

Bif. de Libos

Monsempron - Libos (112)

Poste 1

Viaduc sur le Lot (213m)

Copéjac (148)

Vers Montauban (30)

Abords de Cahors

Abords de Brive (voir 205)

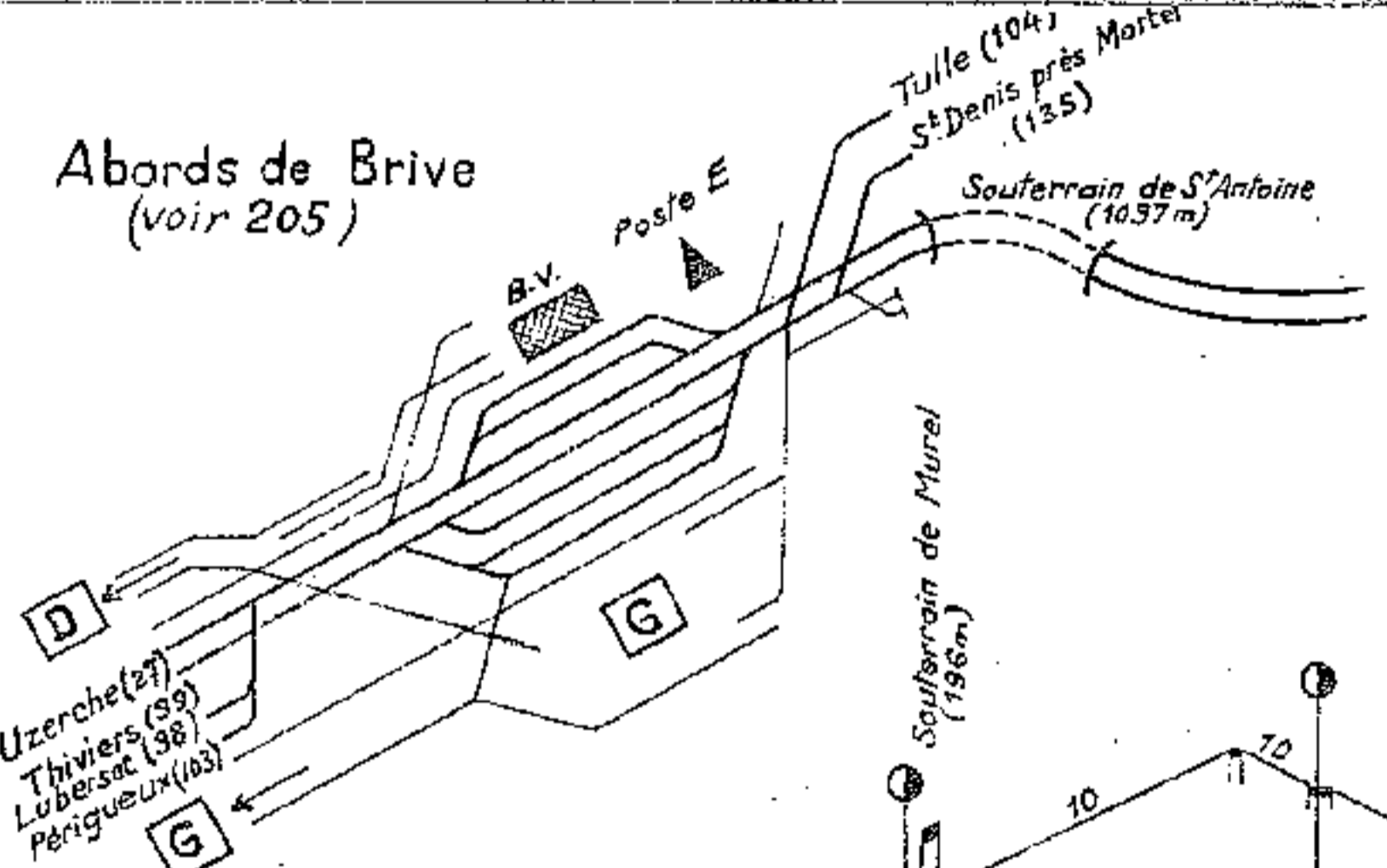

Abords de Souillac

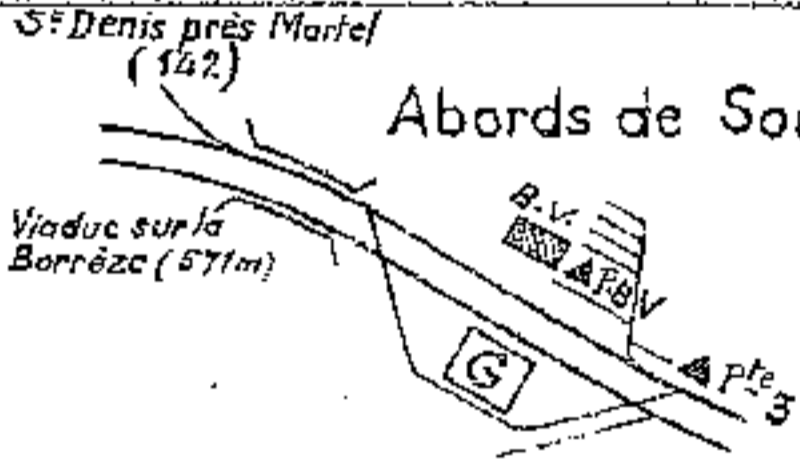

Ligne de Brive à Montauban

Section de Brive à Gourdon

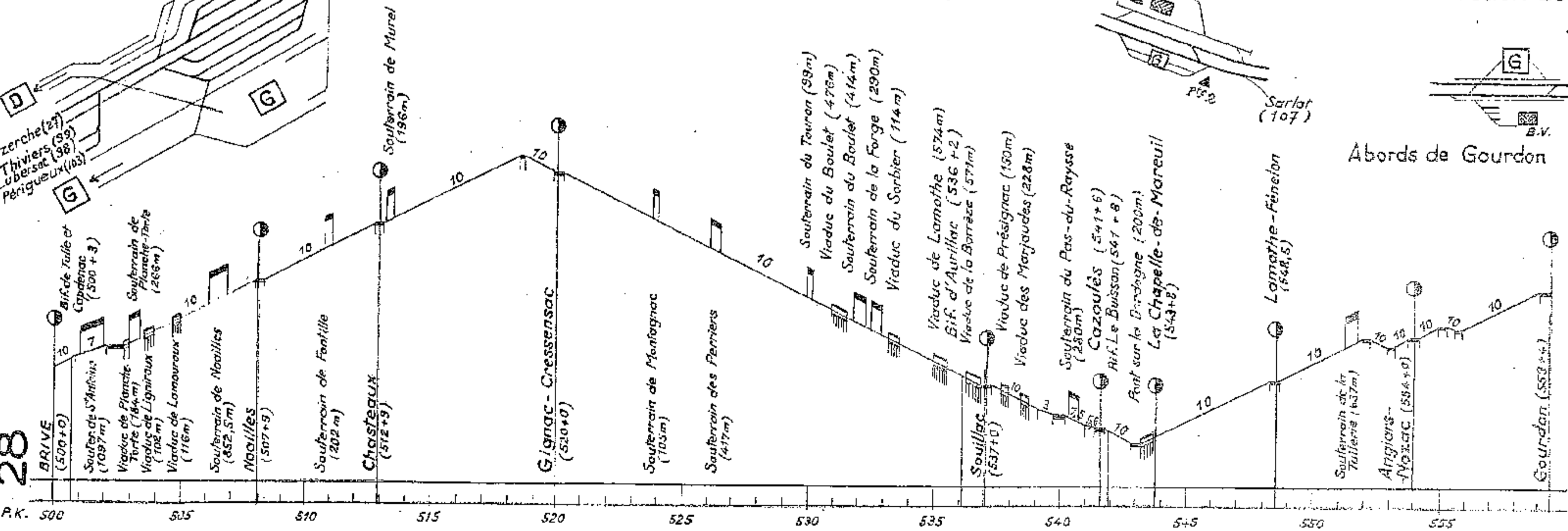

Abords de Cazoulès

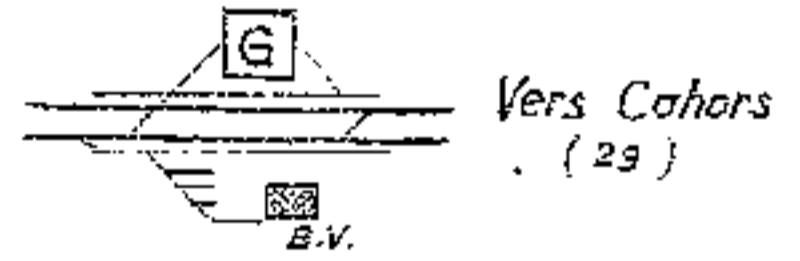
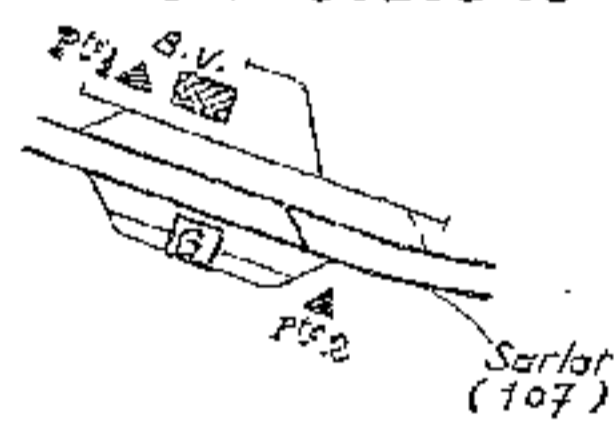

Abords de Gourdon

Abords de Bordeaux-S^t Jean voir (203)

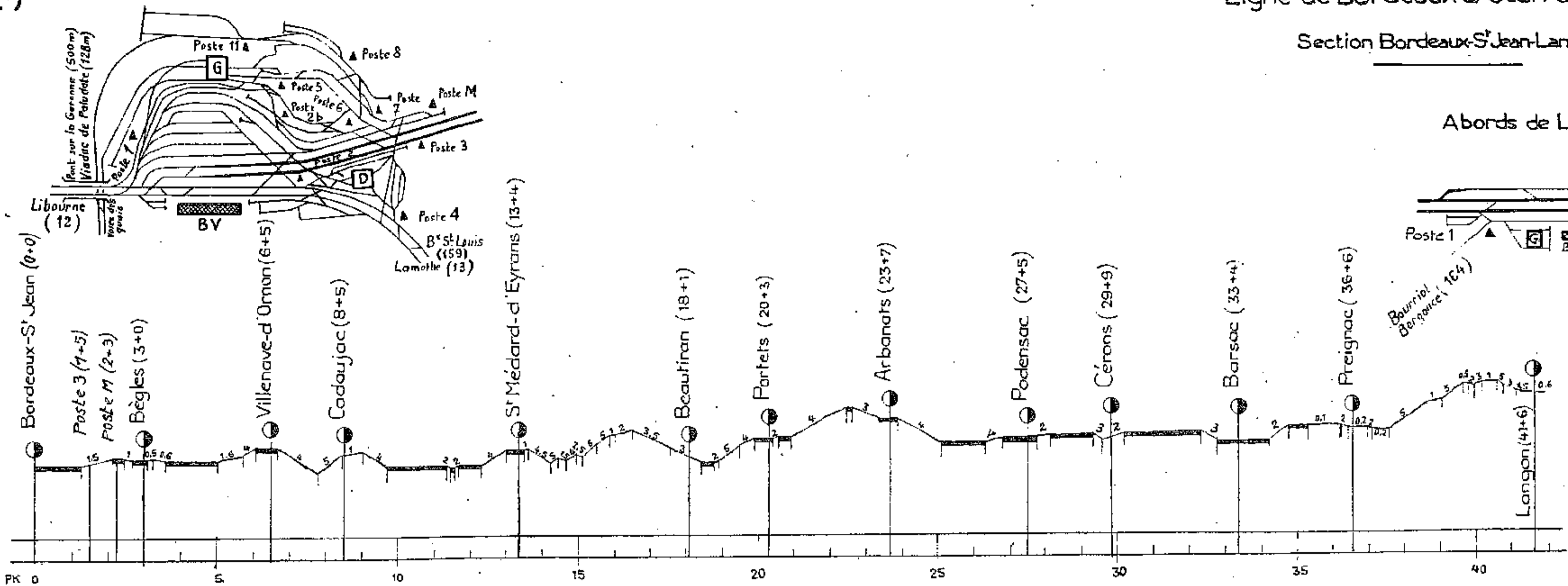

Ligne de Bordeaux-S^t Jean à Agen

Section Bordeaux-S^t Jean-Langon

Abords de Langon



Ligne de Brive à Montauban

Section de Cahors à Montauban

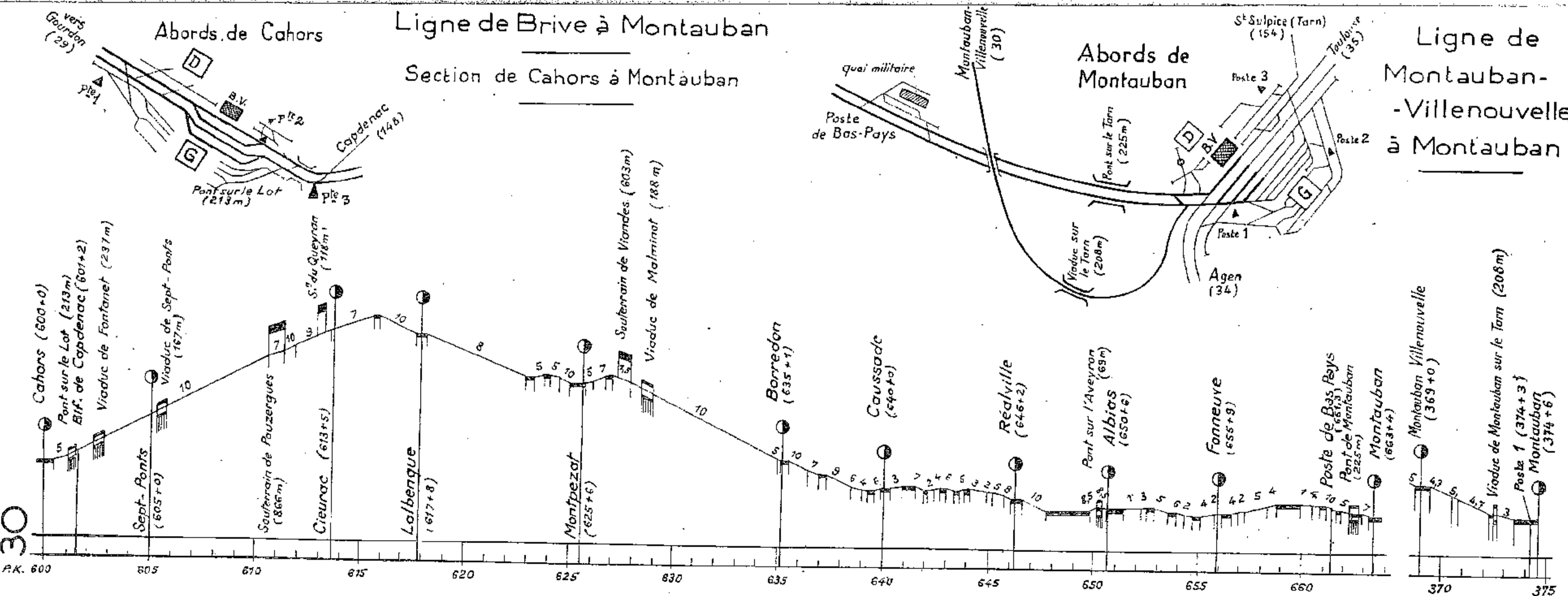

Abords de Montauban

Ligne de Montauban-Villenouvelle à Montauban

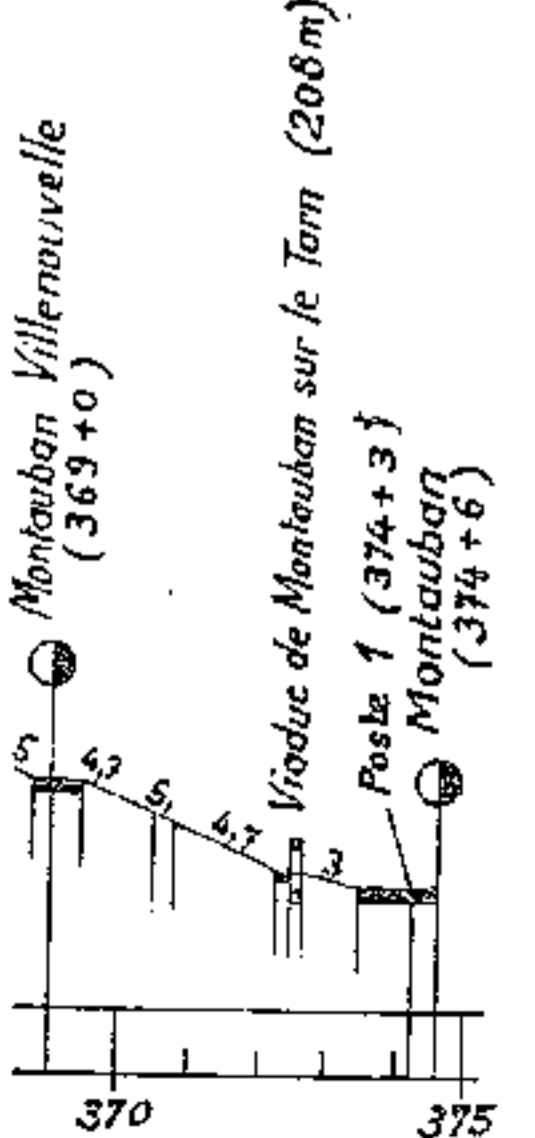

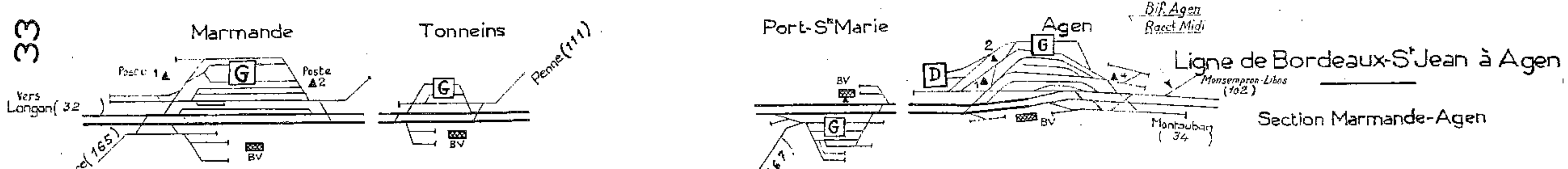

Section Marmande-Agen

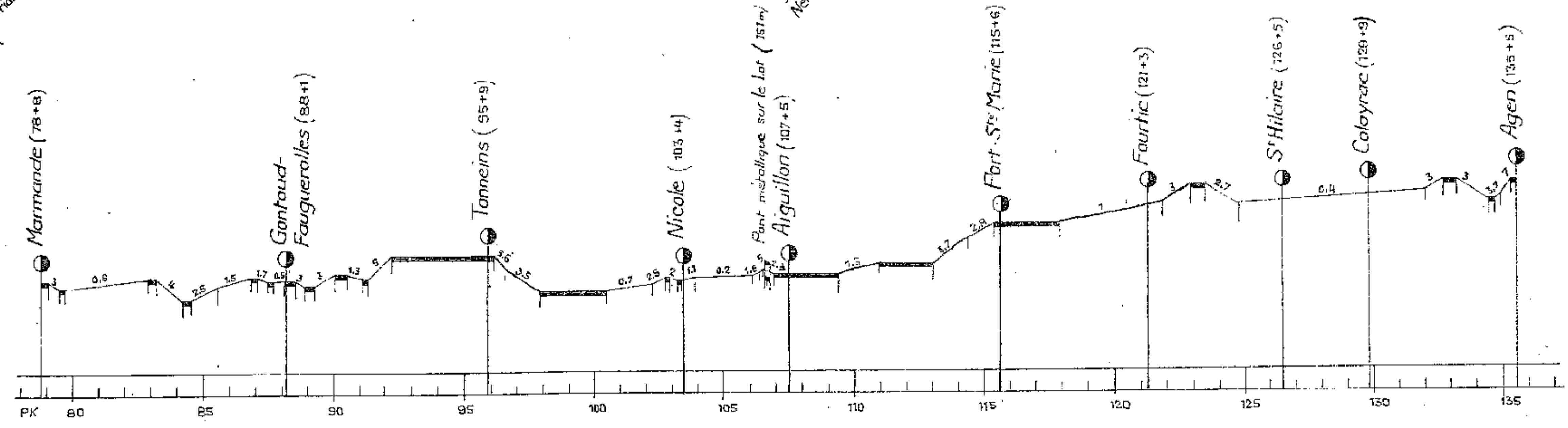

Abords de Langon

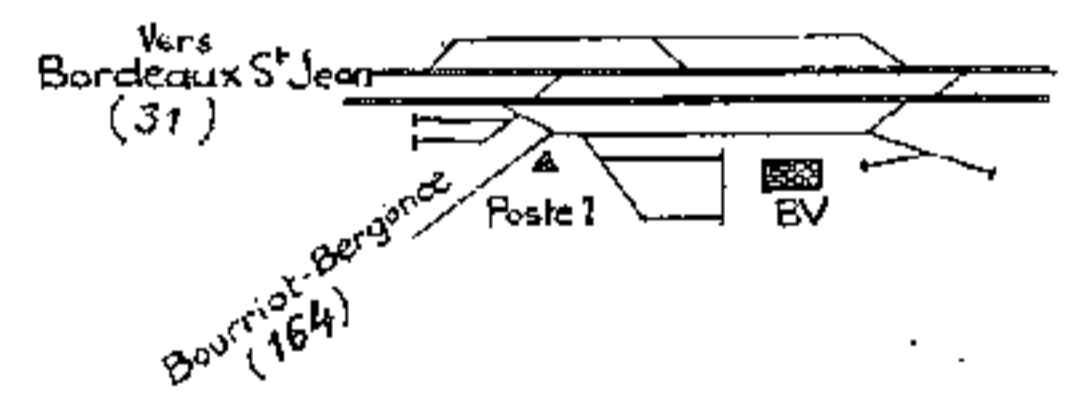

Ligne de Bordeaux-S' Jean à Agen

Section Langon-Marmande

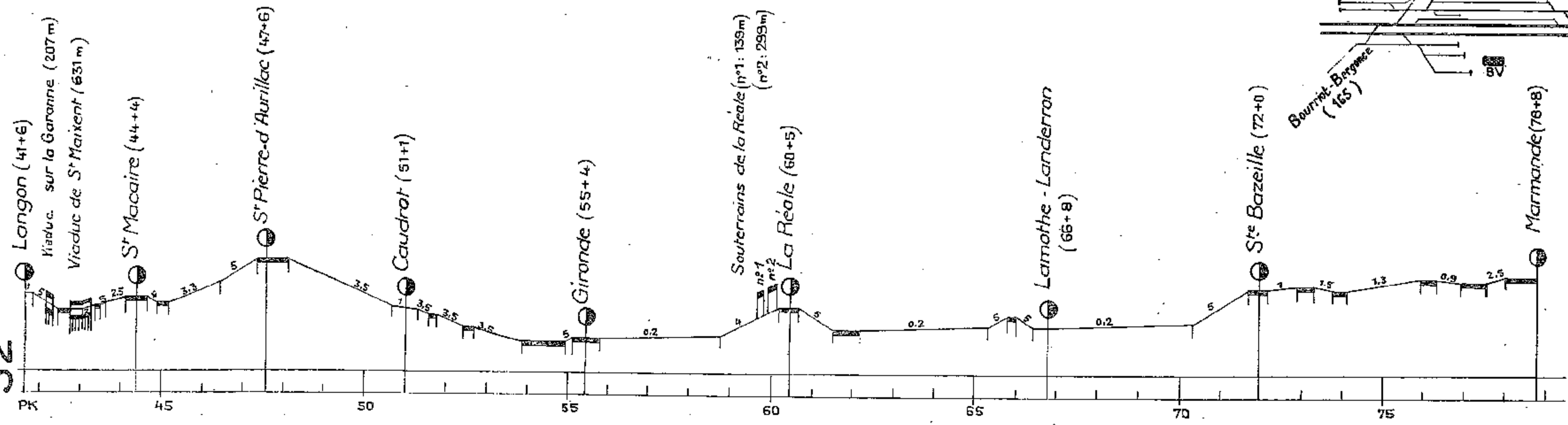
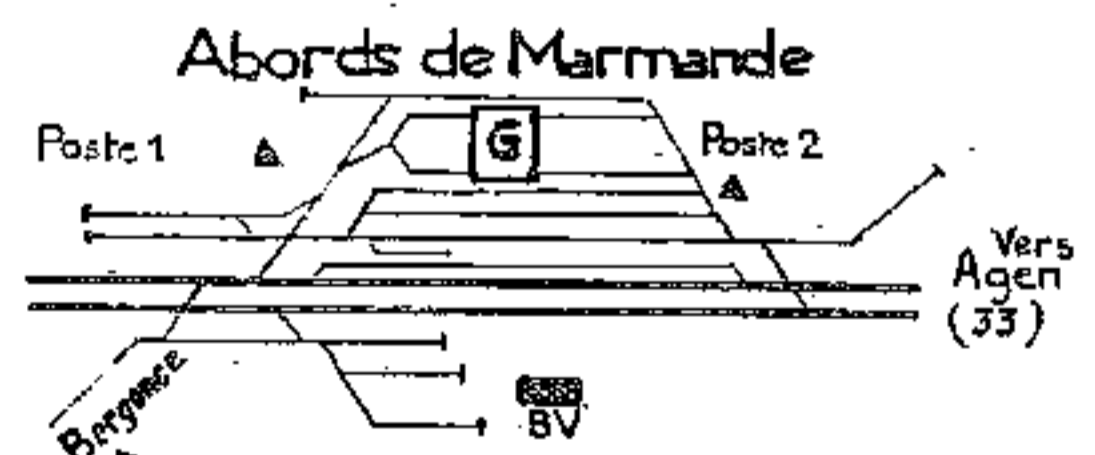

Section Langon-Marmande

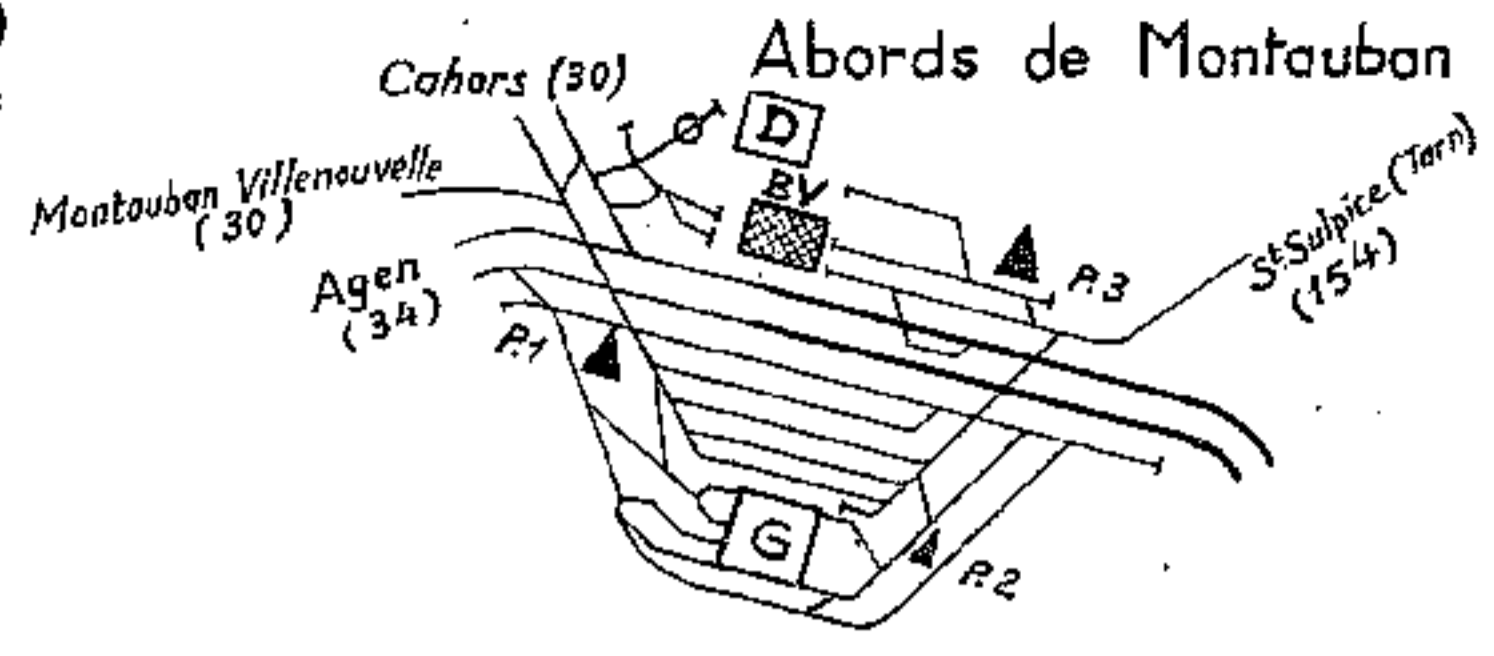

Abords de St Jory - Triage

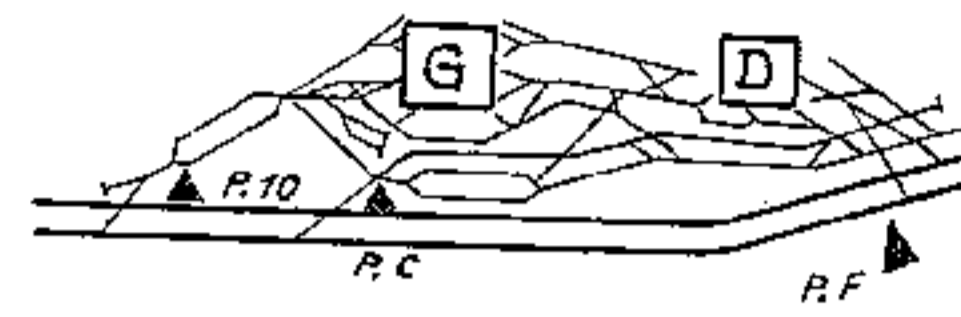

Ligne de Montauban à Narbonne

Section de Montauban à Toulouse

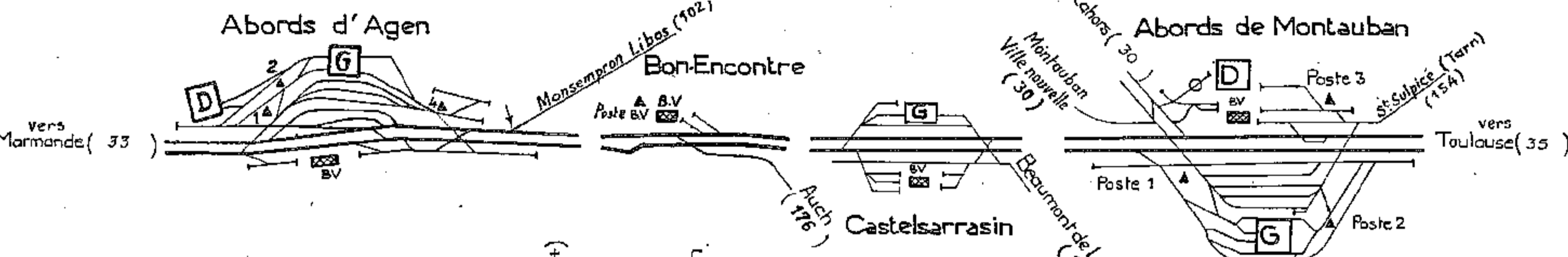
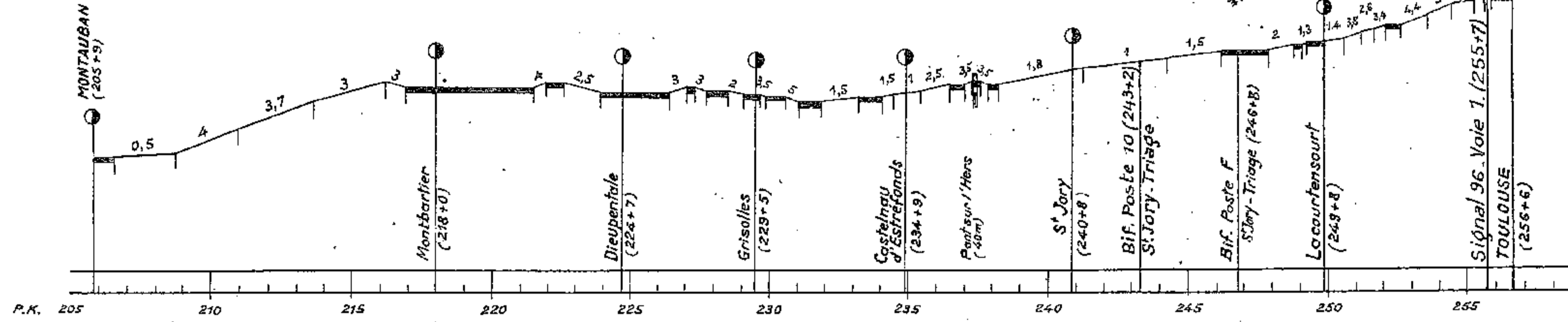
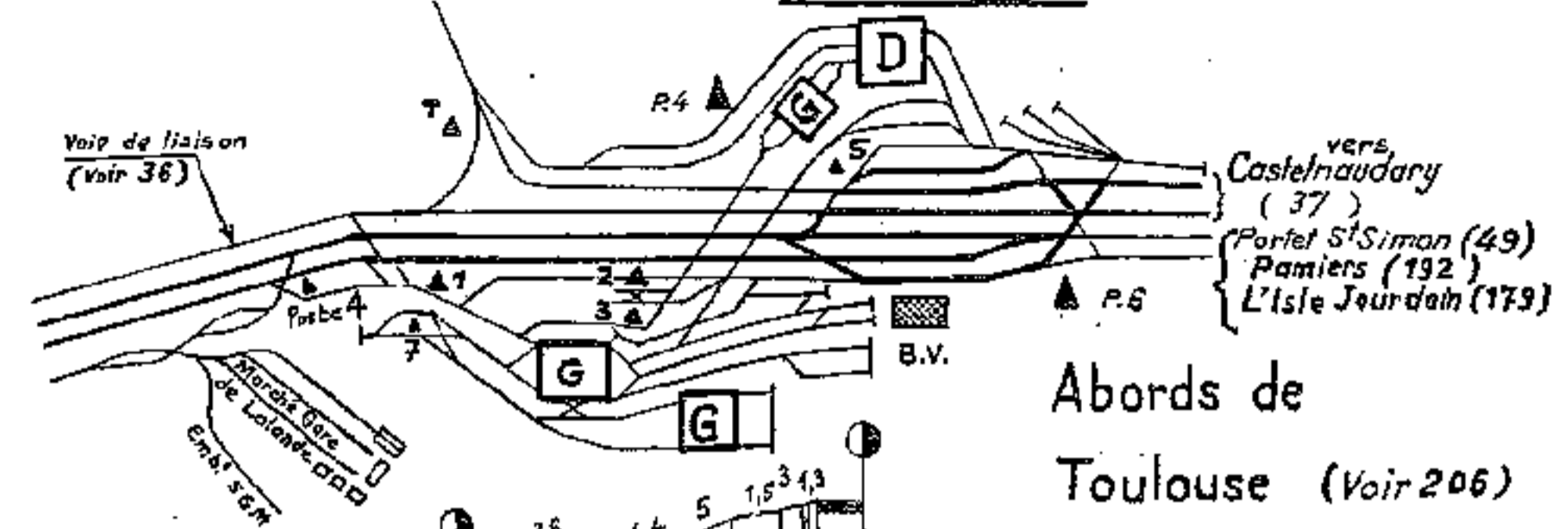

Ligne d'Agen à Montauban

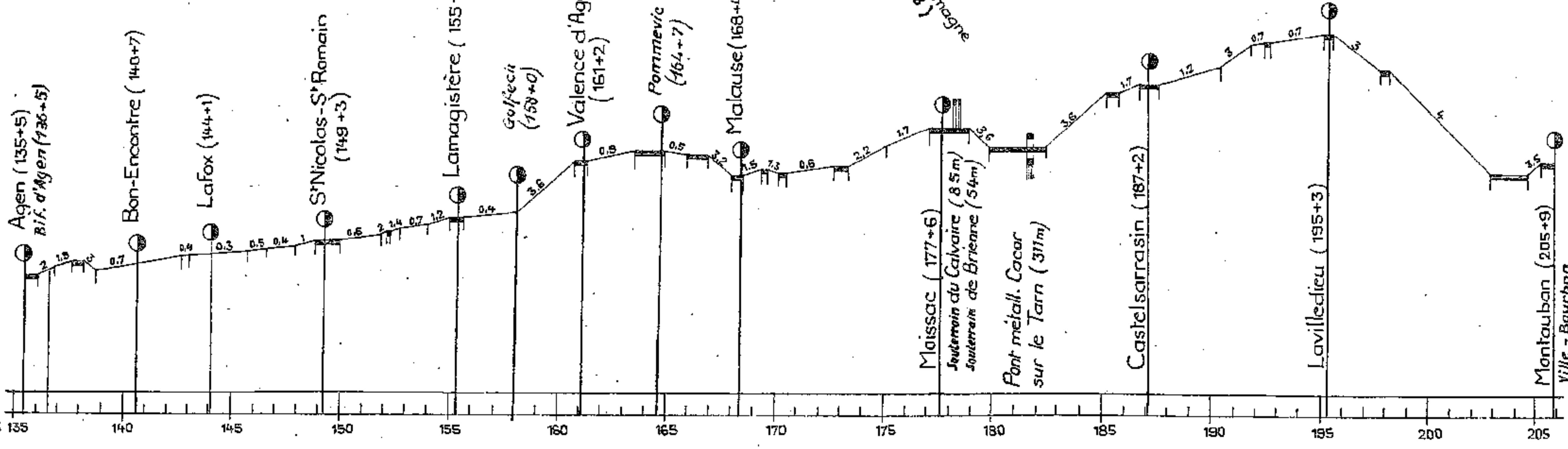

Abords de Toulouse

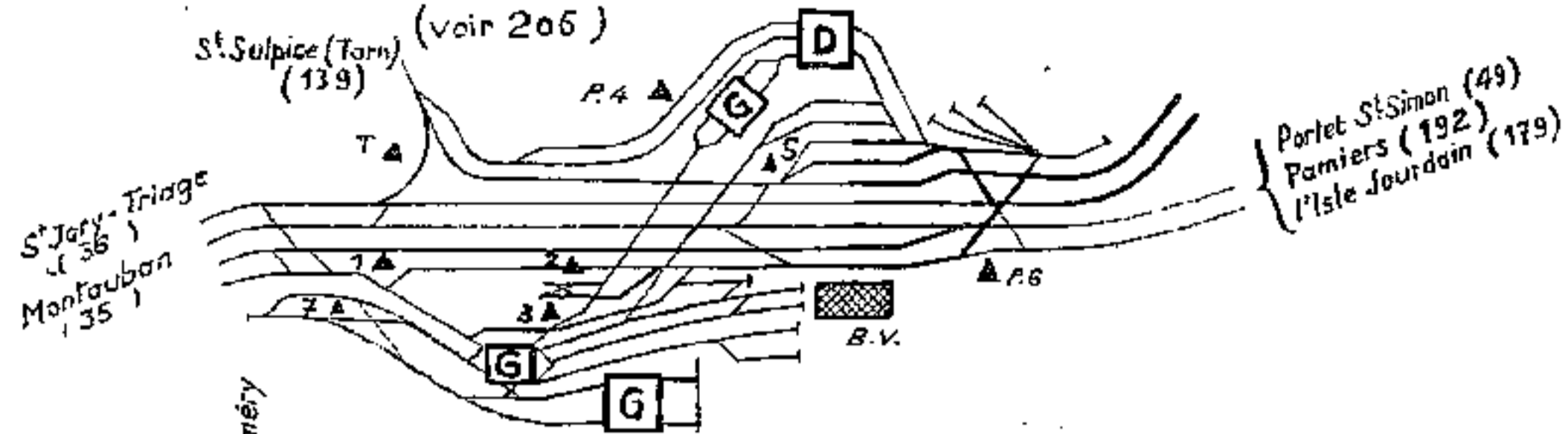

Abords de Castelnaudary

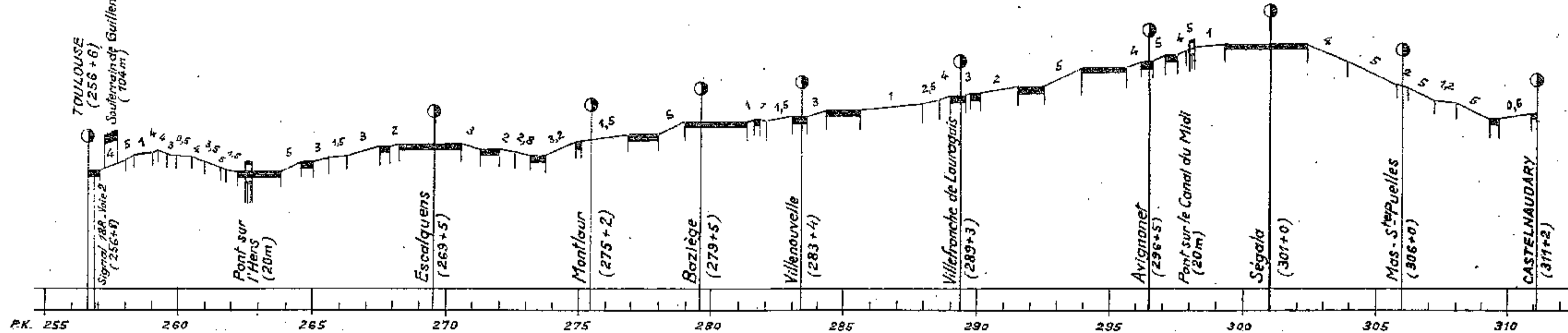
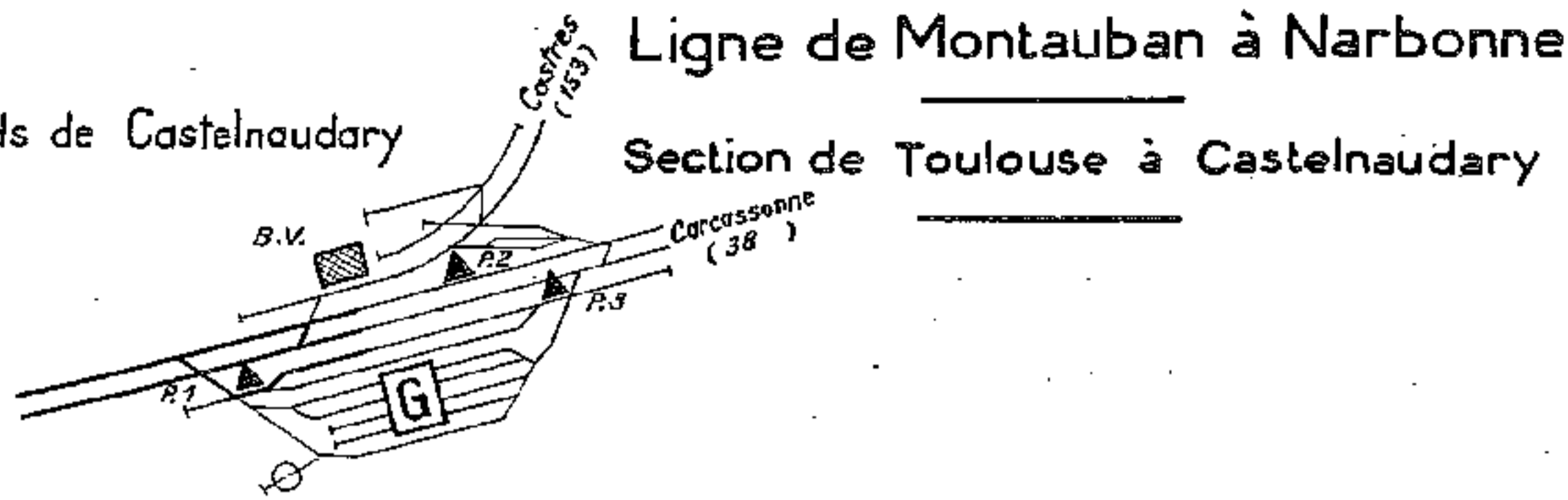

St Jory-Triage

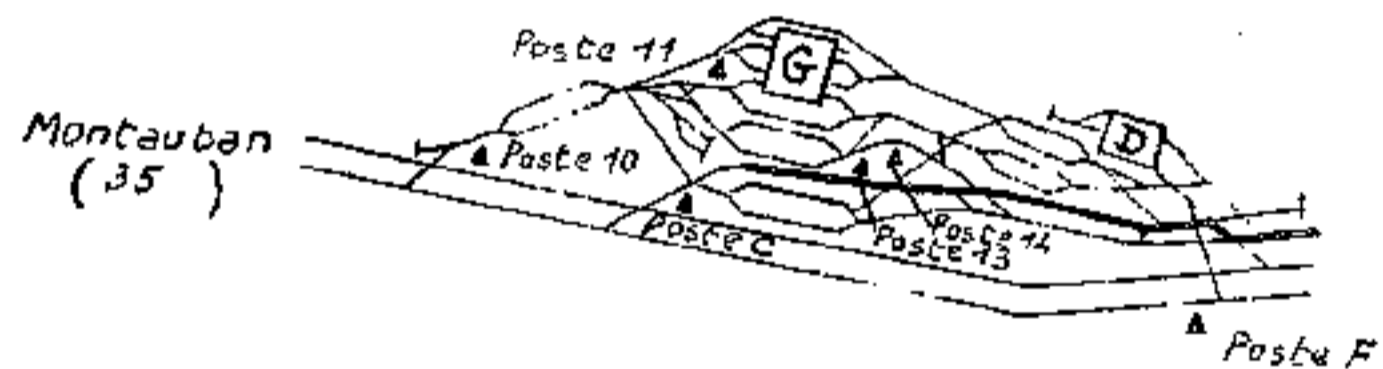

Voie de liaison St Jory-Triage - Toulouse-Matabiau

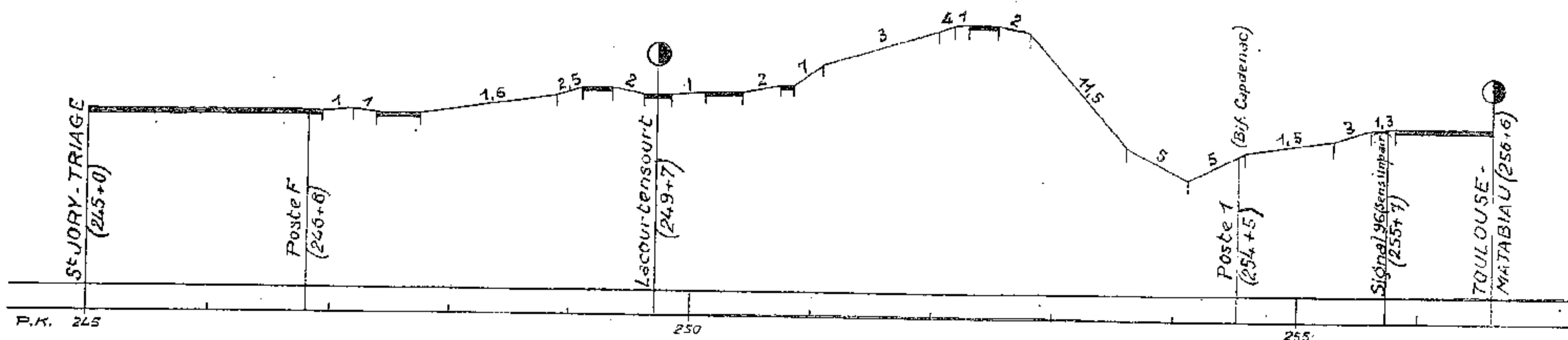
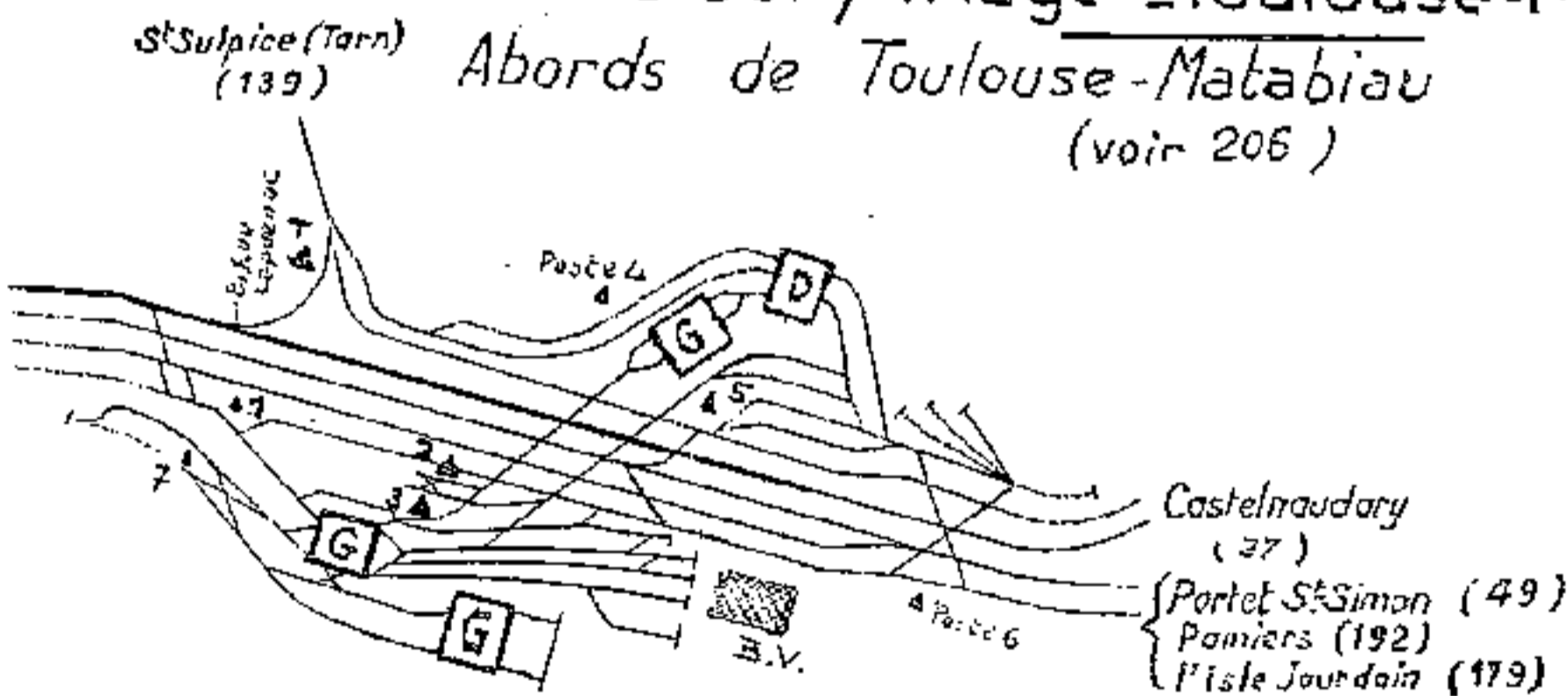

Abords de Carcassonne

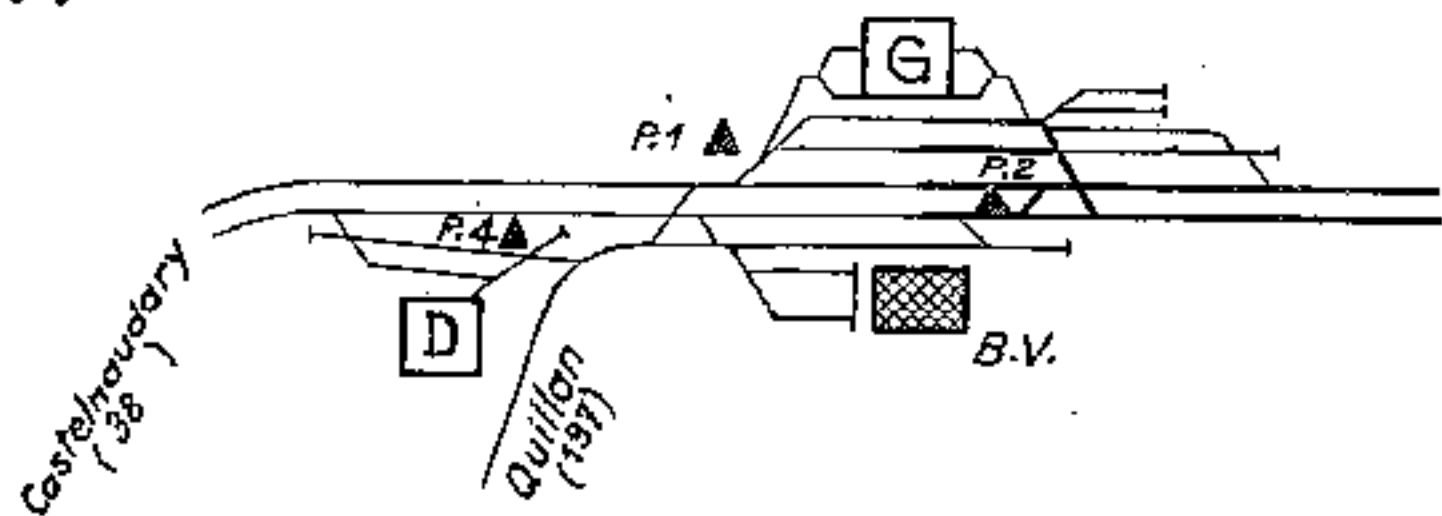

Abords de Moux

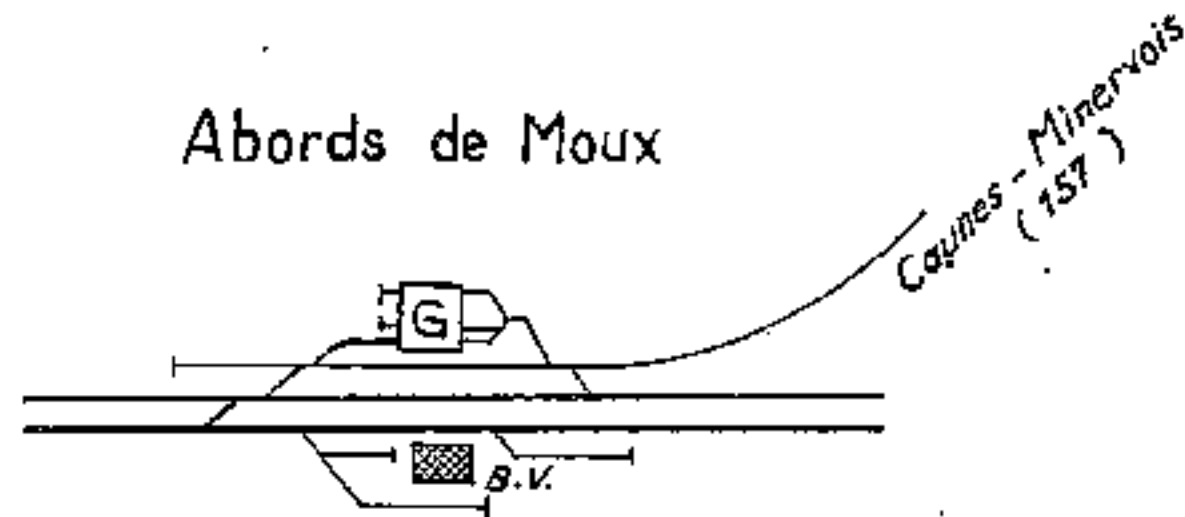

Ligne de Montauban à Narbonne
Section de Carcassonne à Narbonne

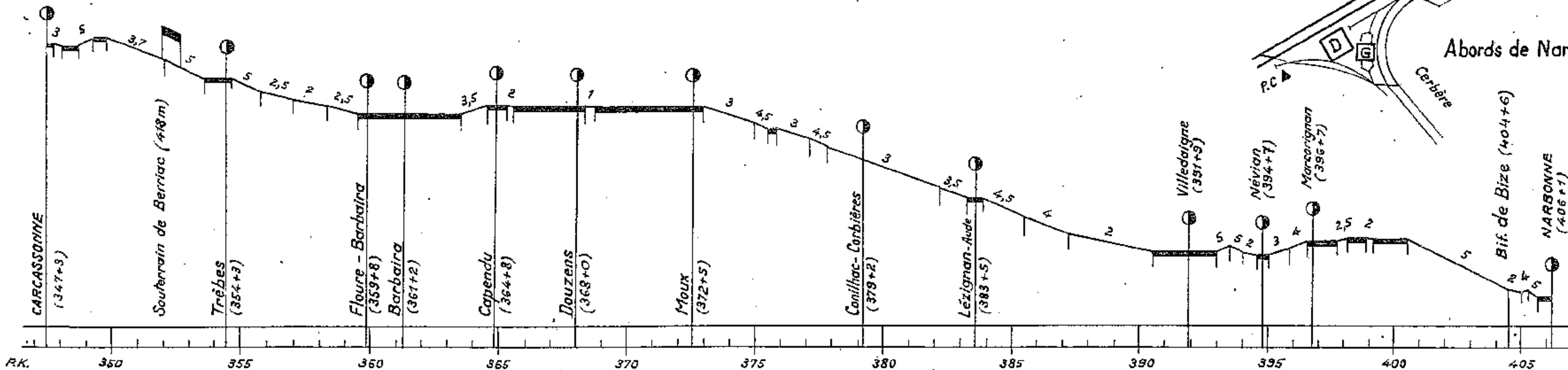
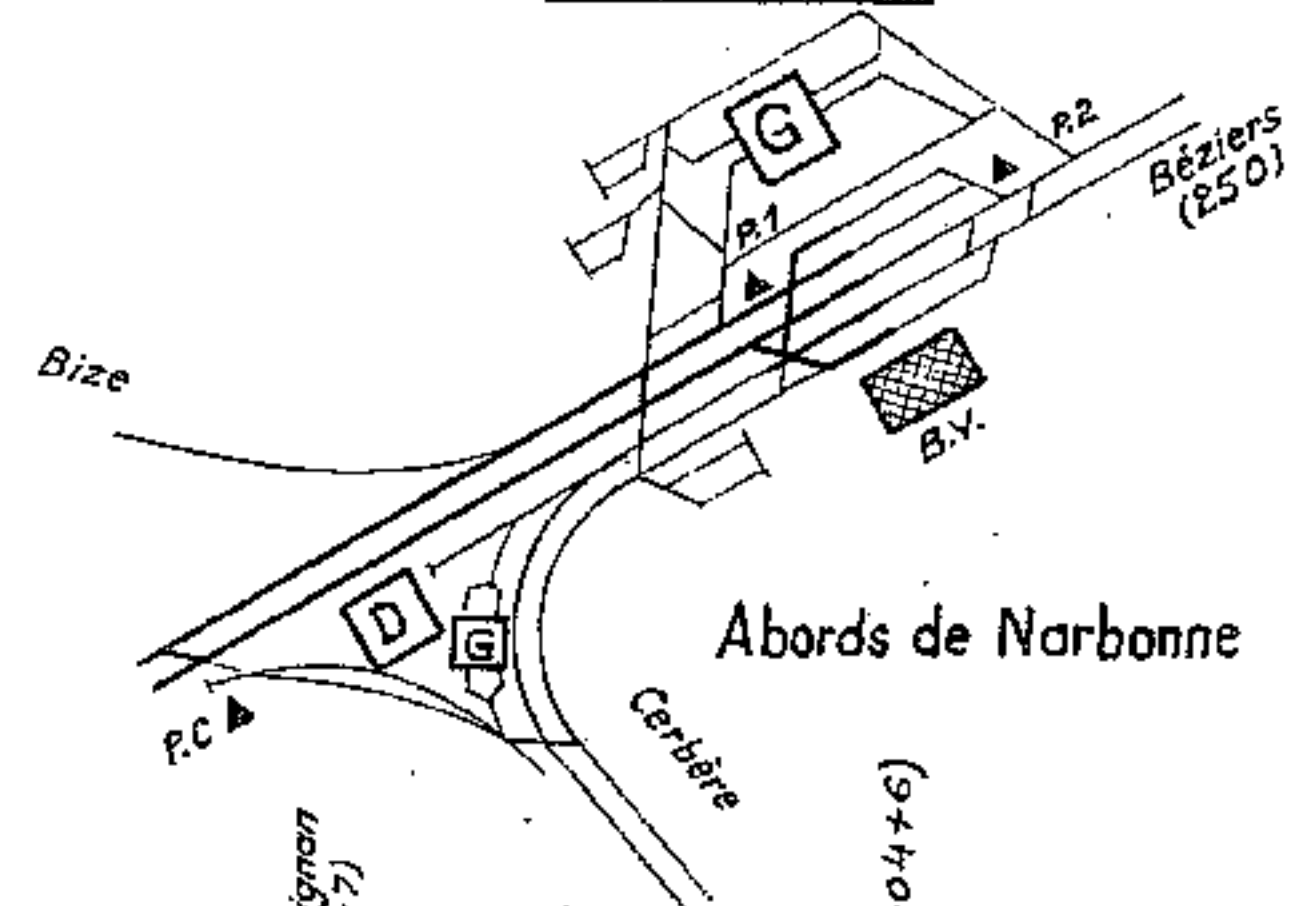

Abords de Castelnaudary

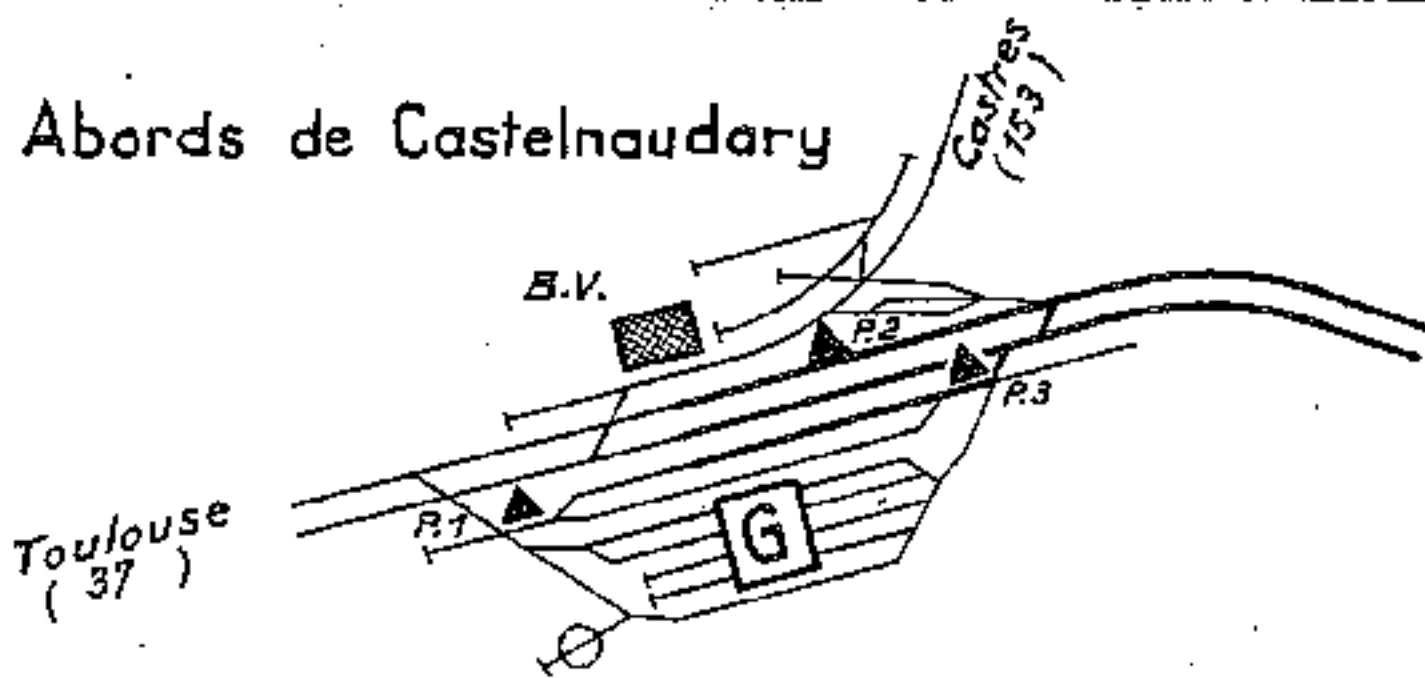

Abords de Bram

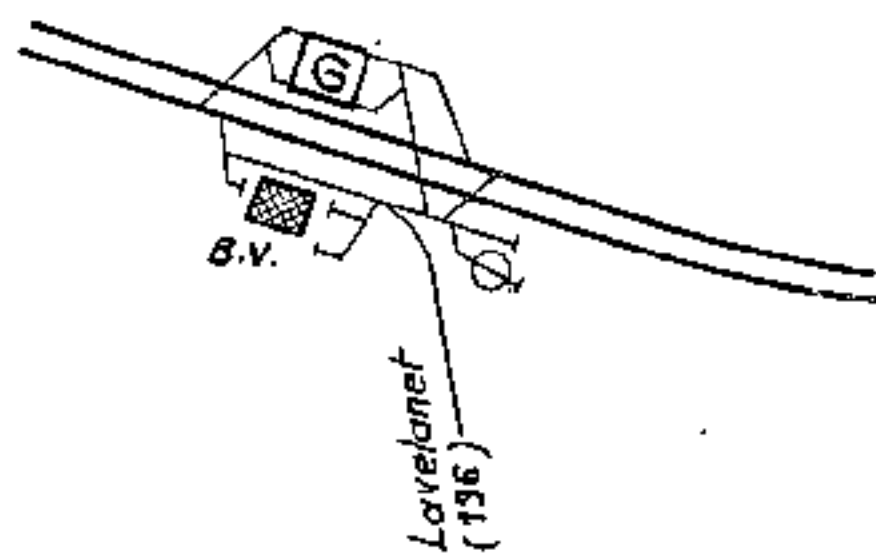

Ligne de Montauban à Narbonne
Section de Castelnaudary à Carcassonne

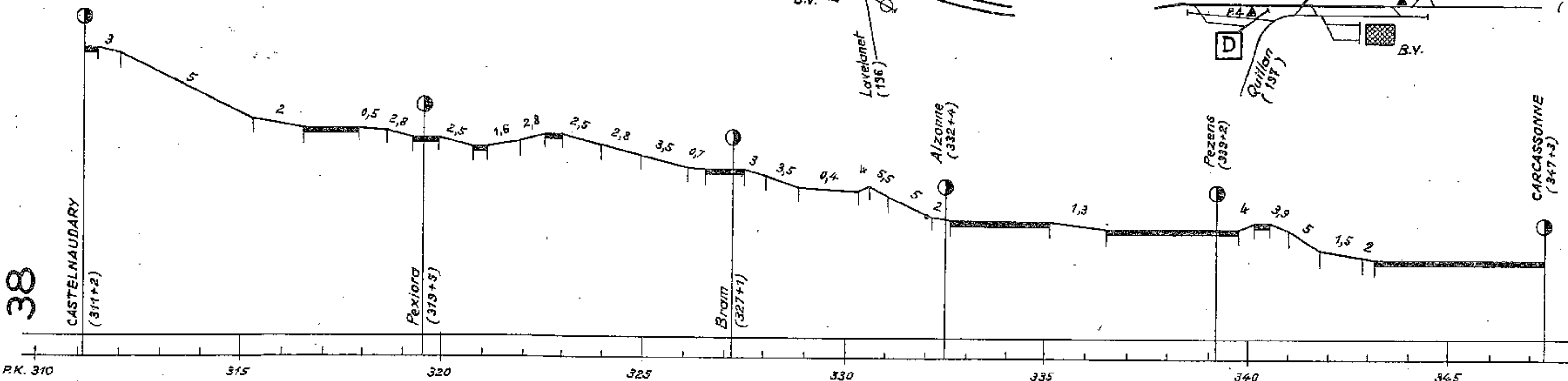
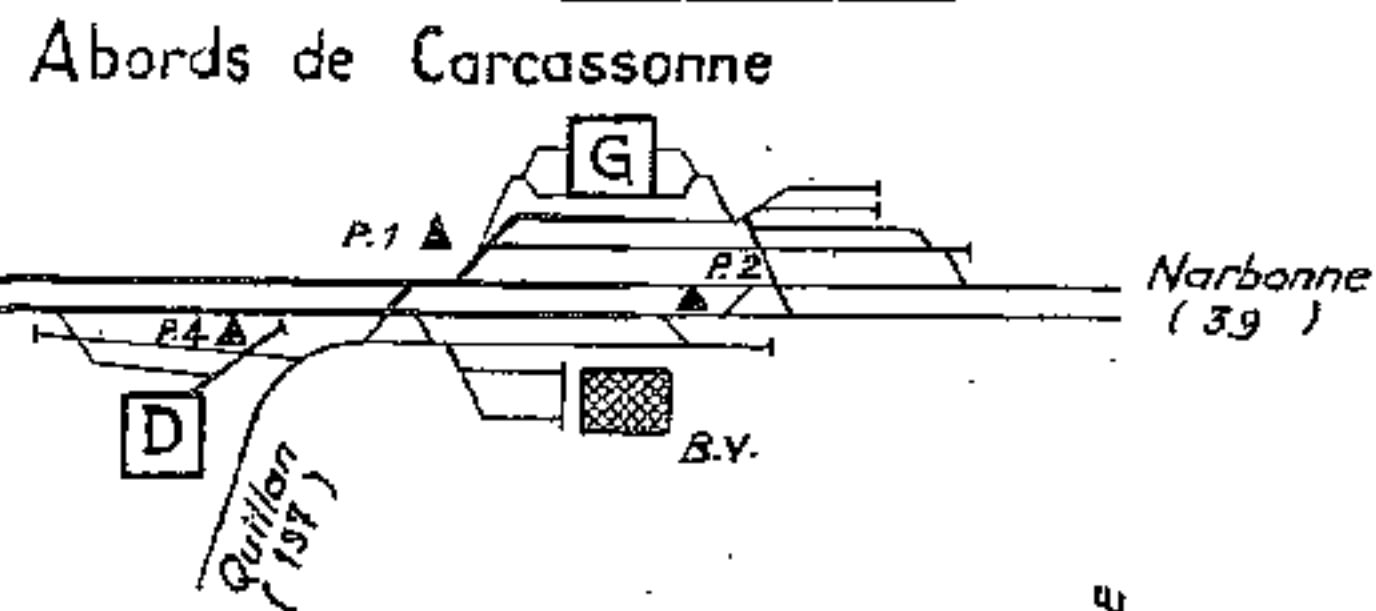

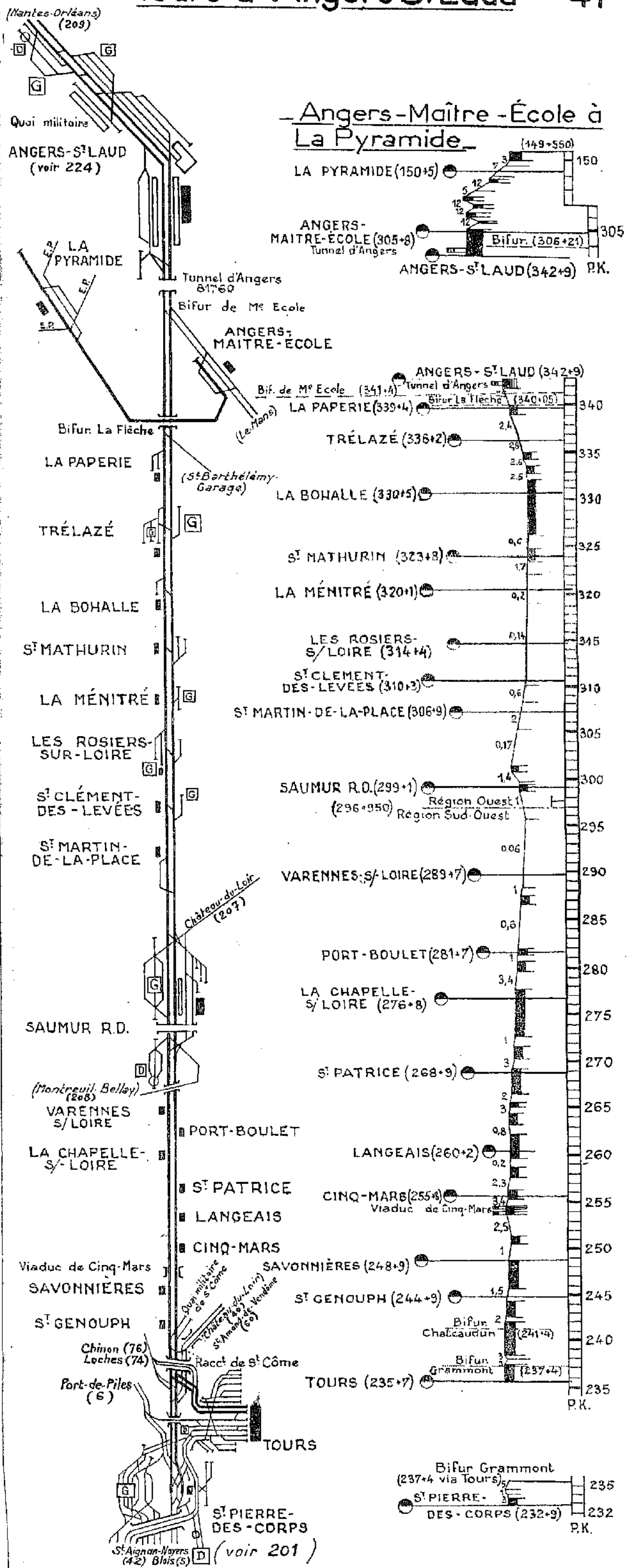
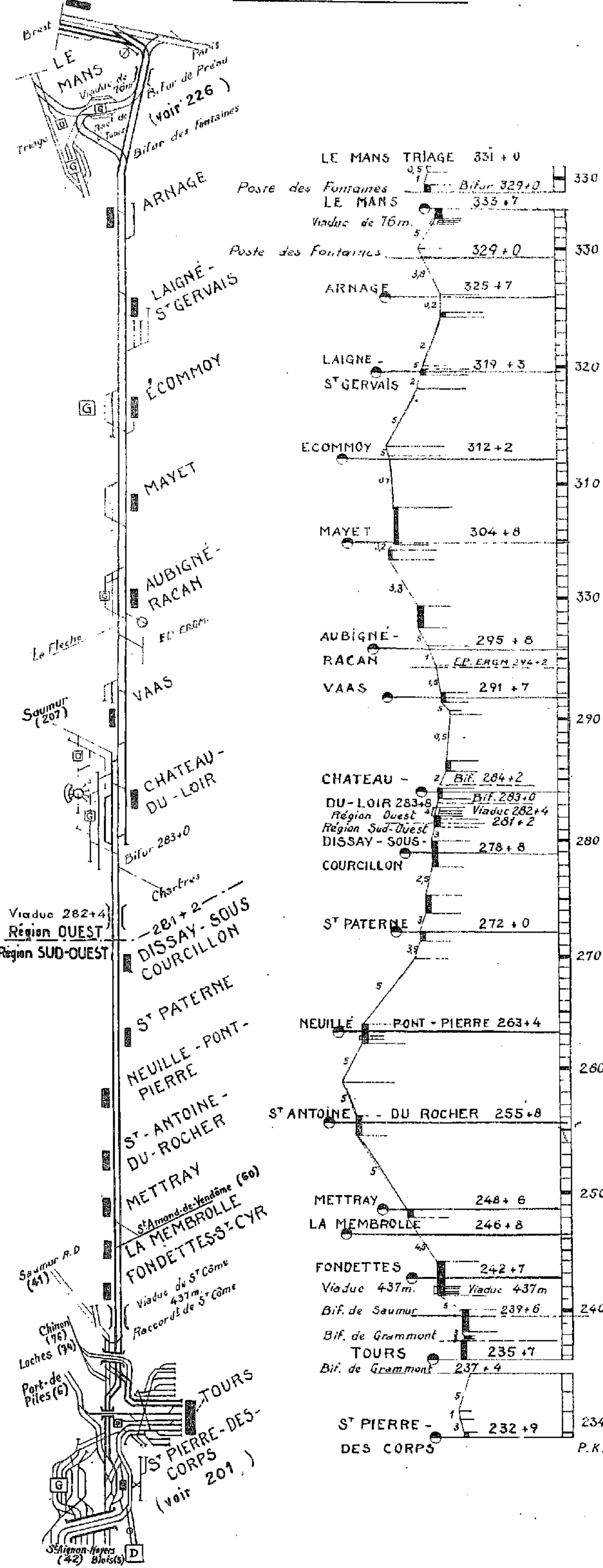

Angers-Maitre-École à La Pyramide

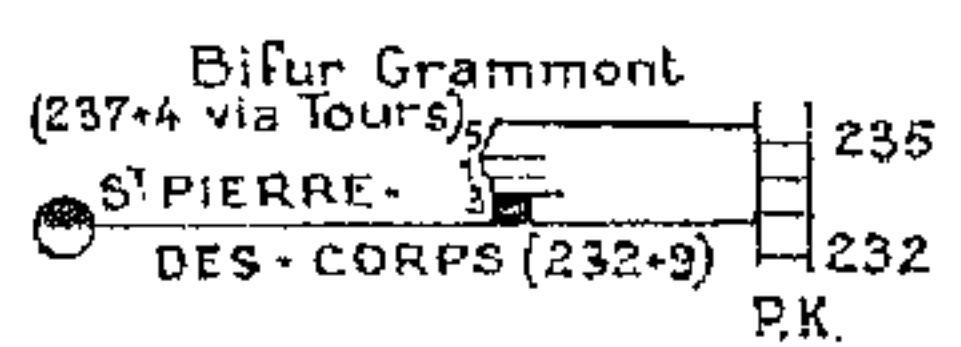
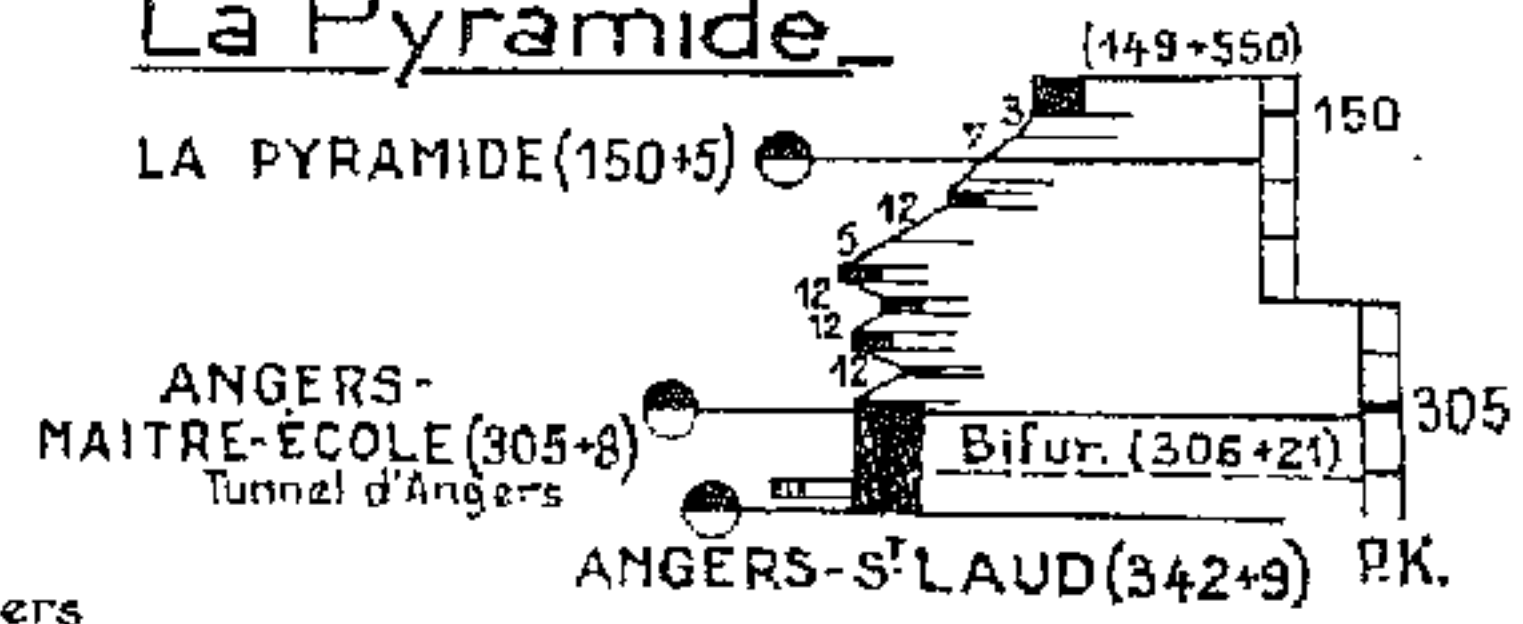

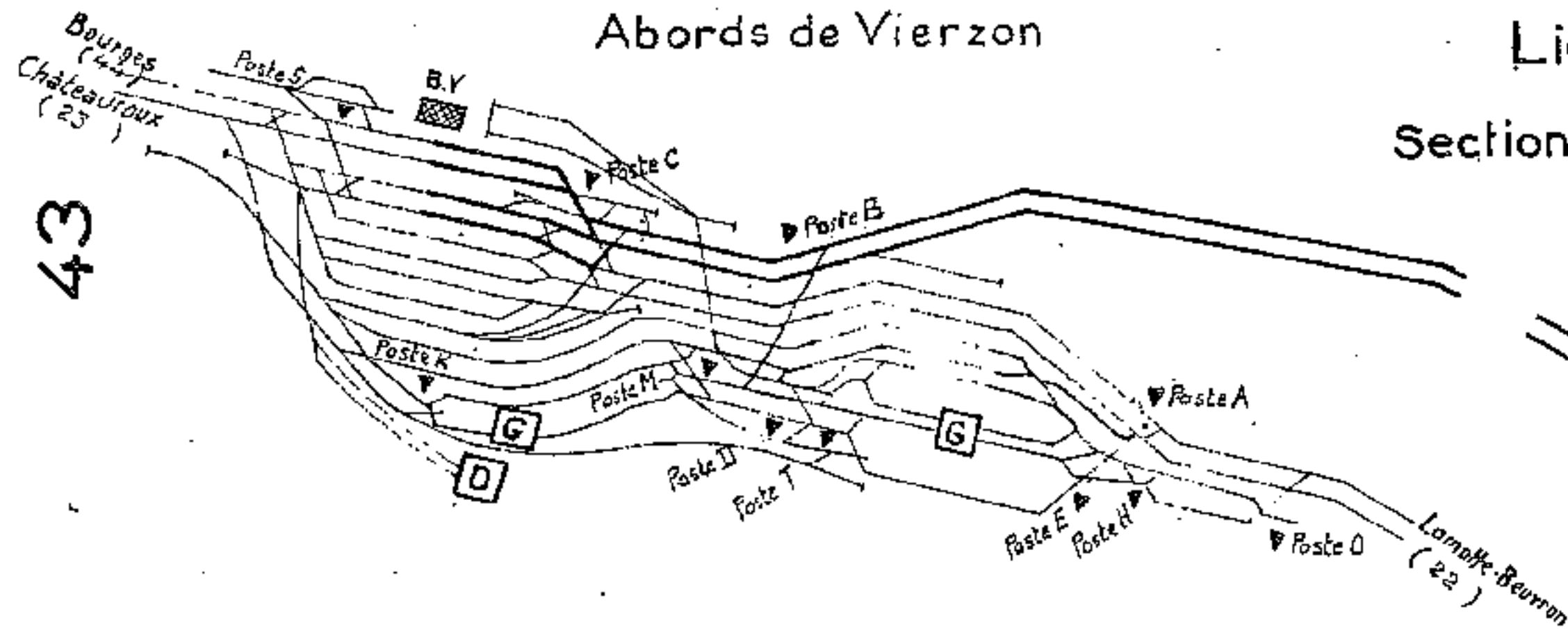

Ligne de Vierzon à Tours
Section de Vierzon à S'Aignan-Noyers

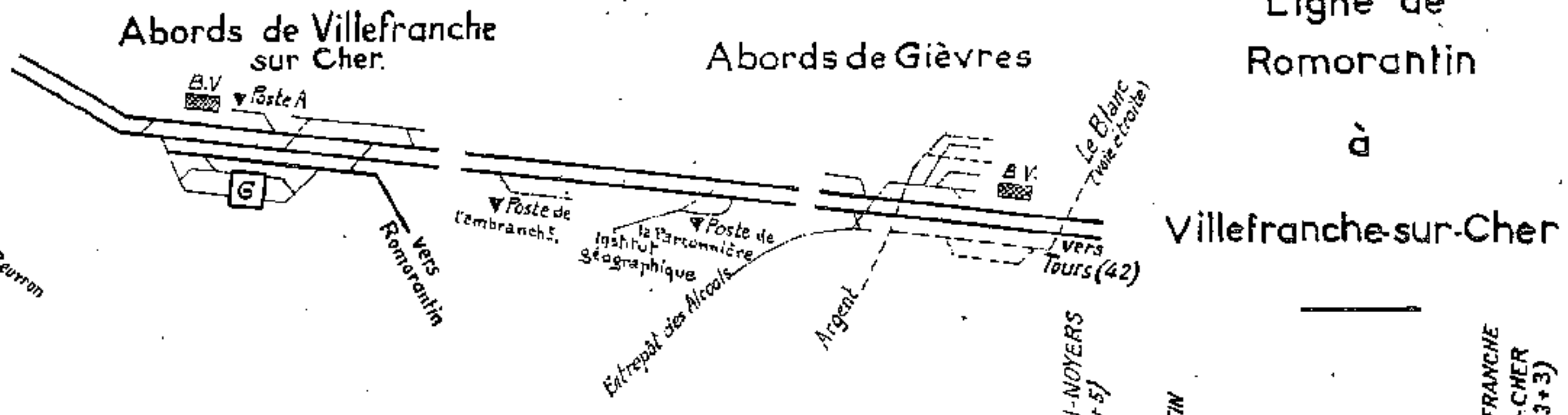

Ligne de Romorantin à Villefranche-sur-Cher

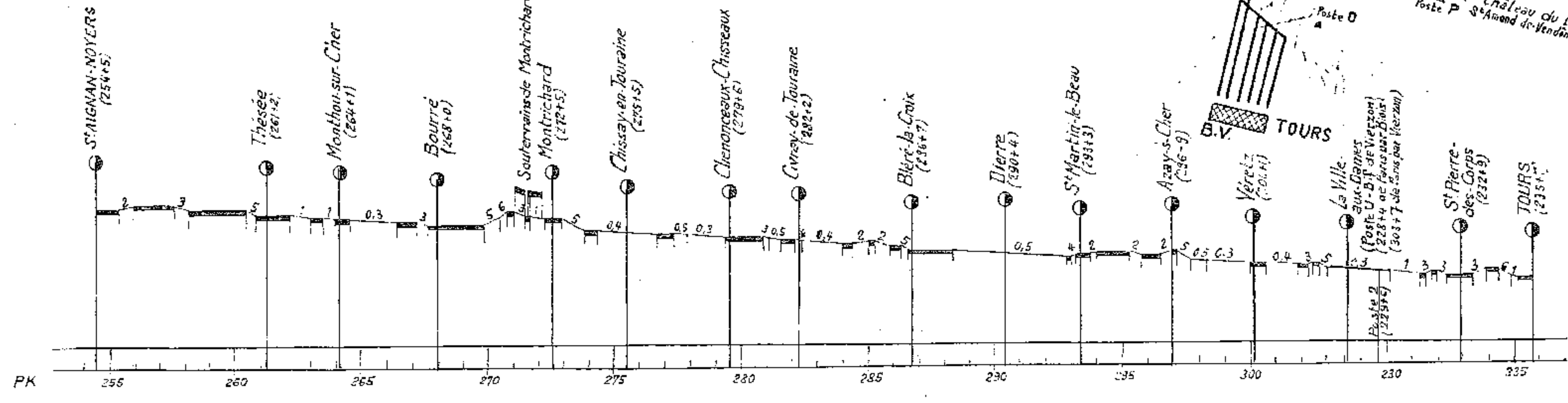
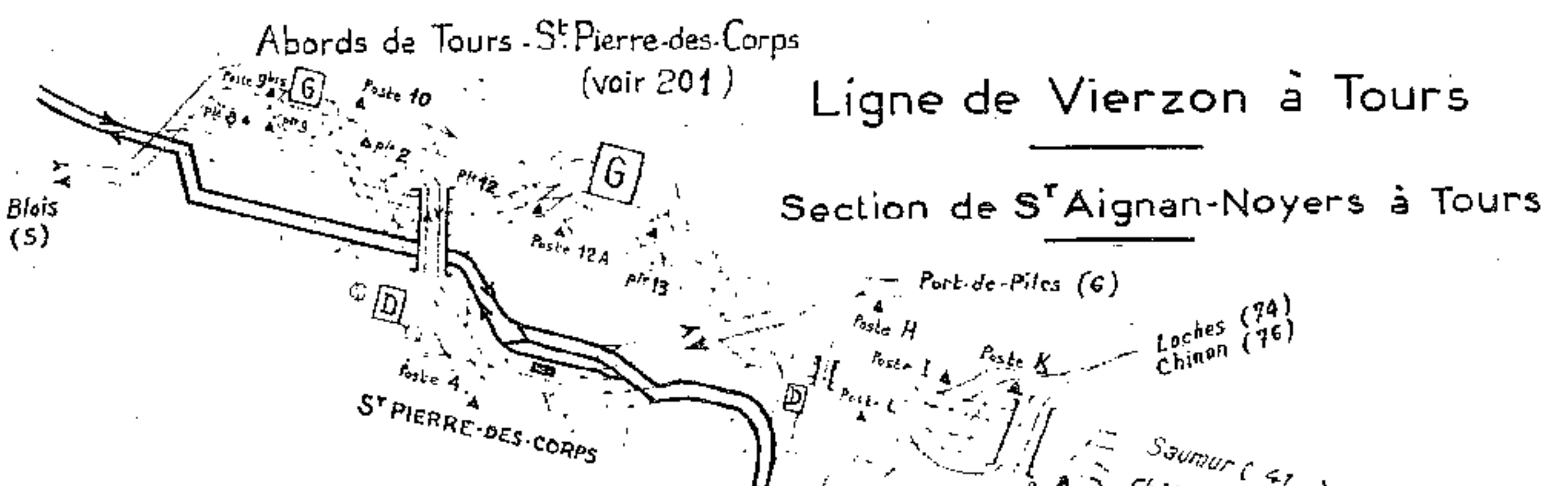
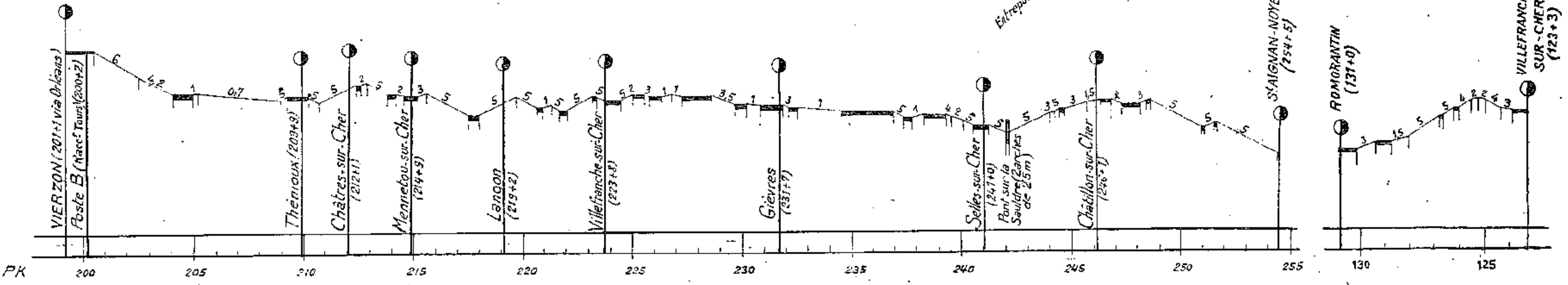

Abords de Bourges

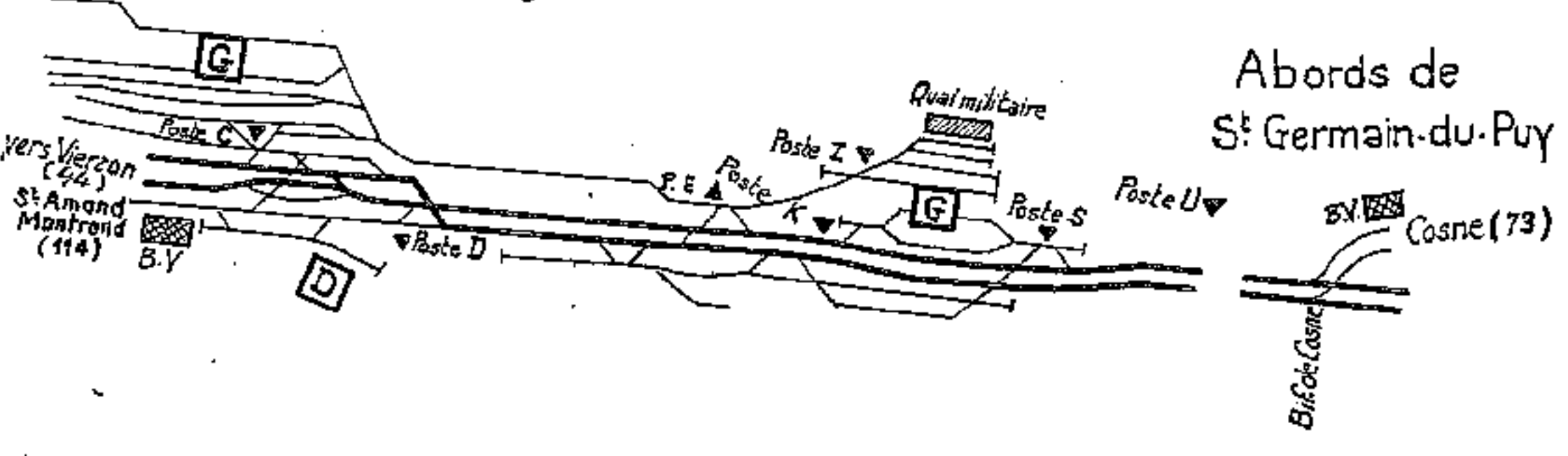

Abords de Saincaize Ligne de Vierzon à Saincaize

Section de Bourges à Saincaize

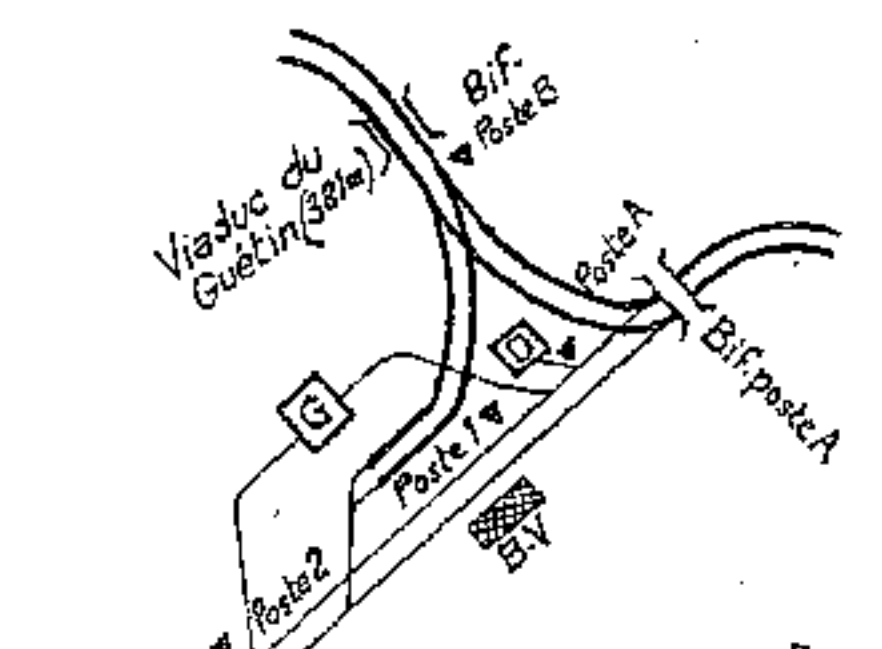

Abords de Nevers

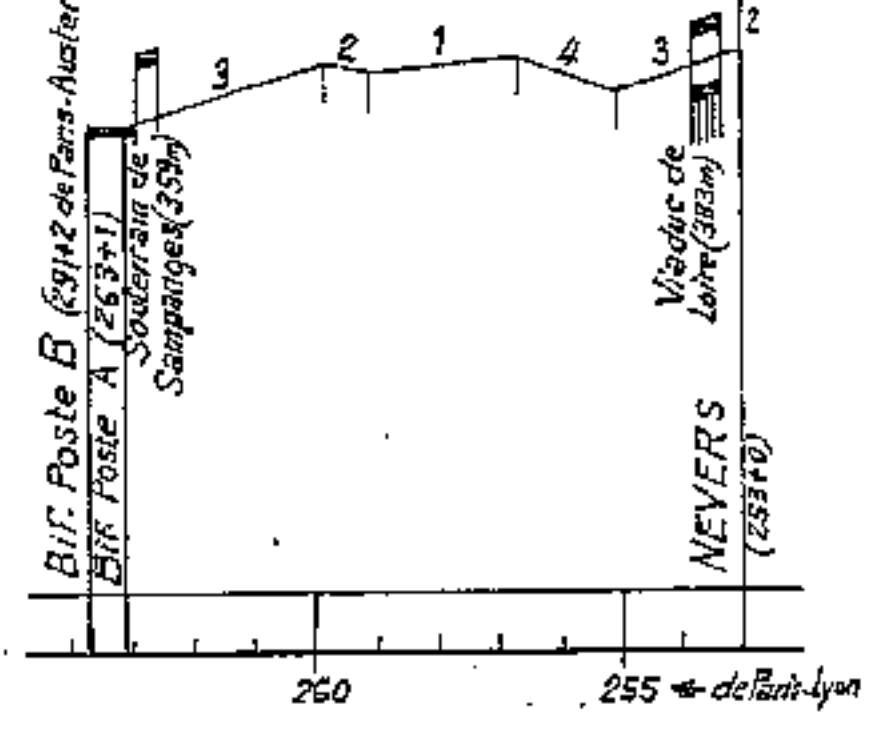
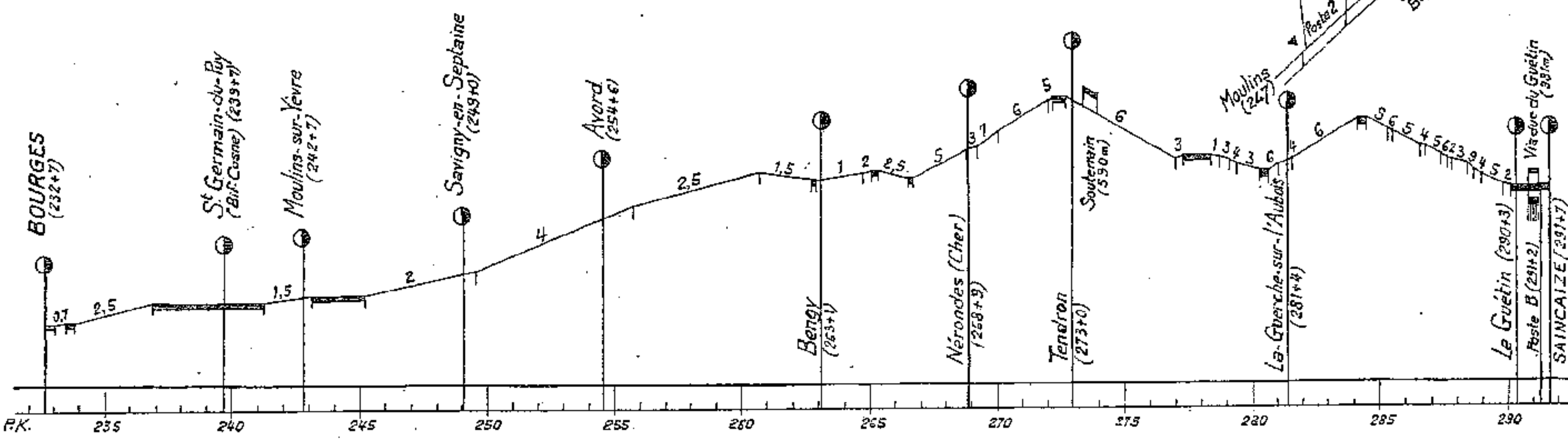
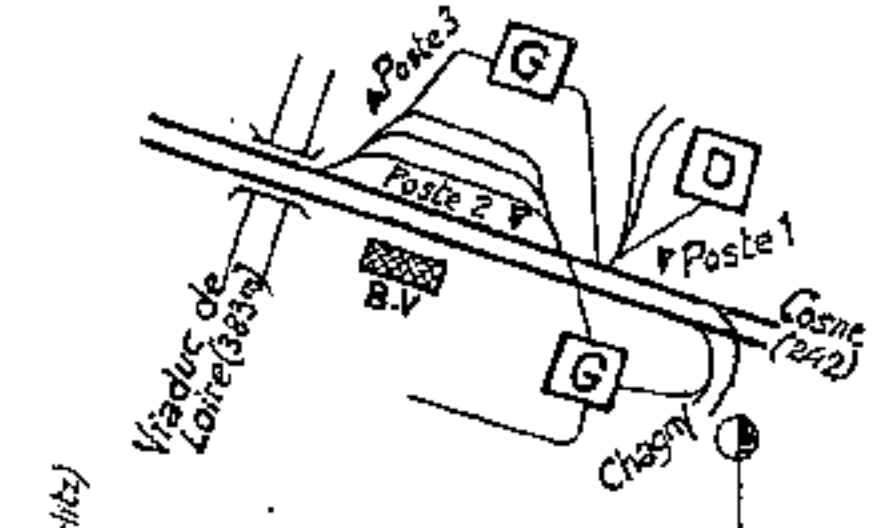

Abords de Vierzon

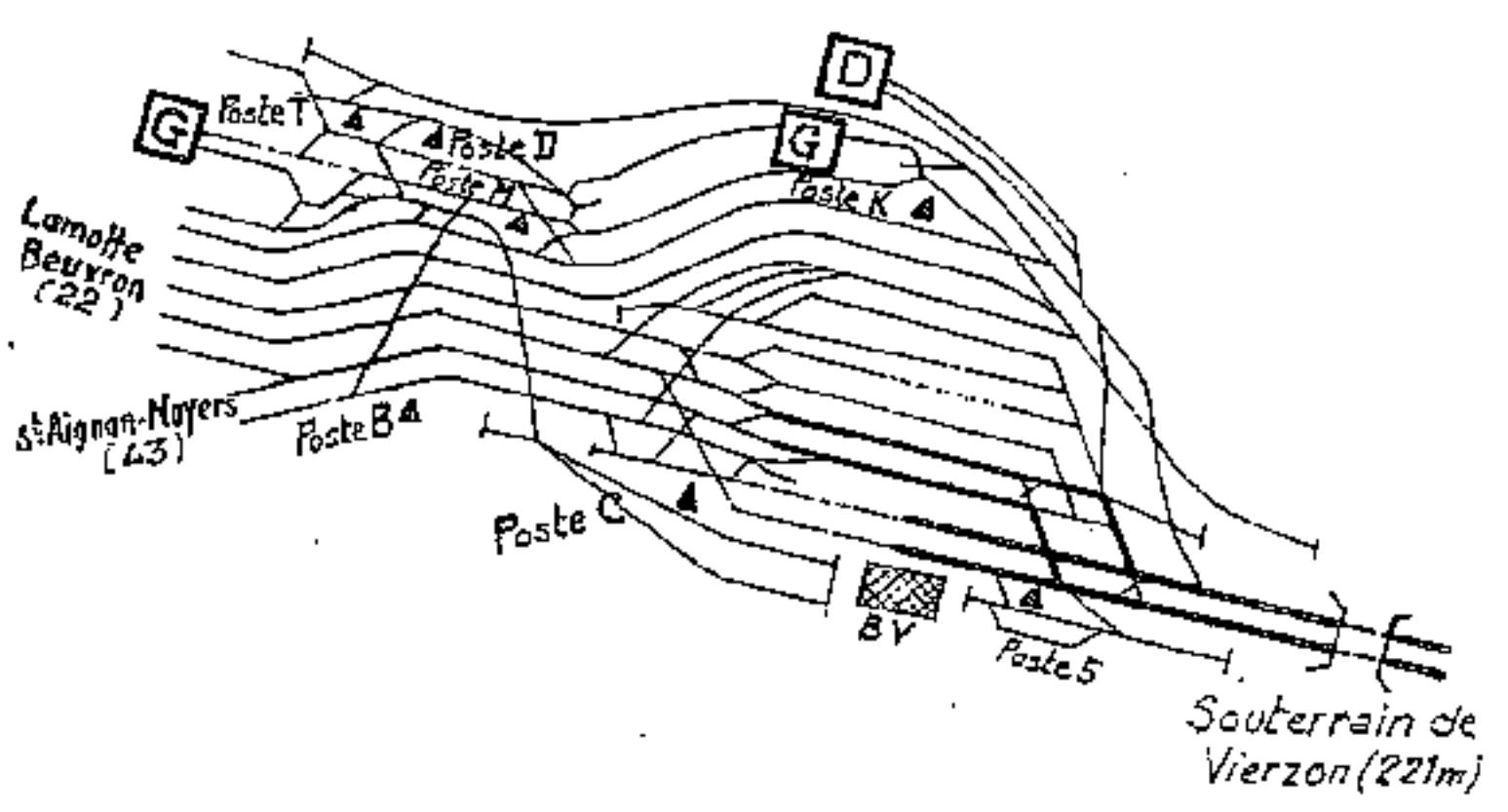

Abords de Vierzon-Forges

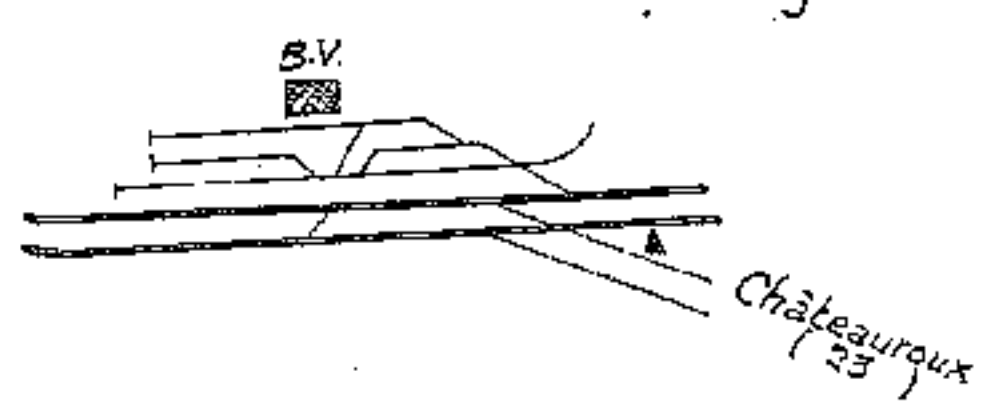

Ligne de Vierzon à Saincaize

Section de Vierzon à Bourges

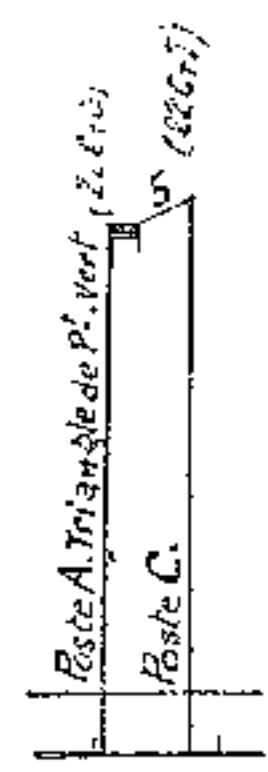
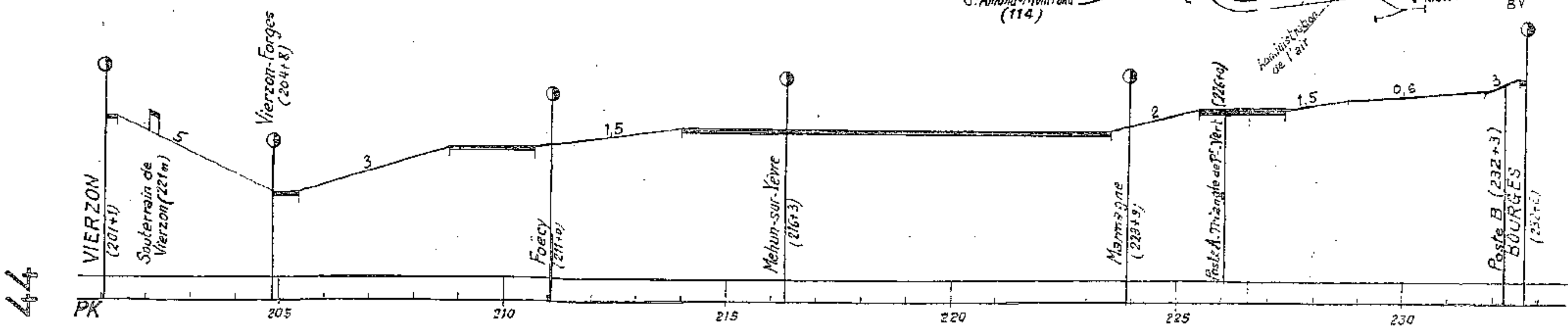
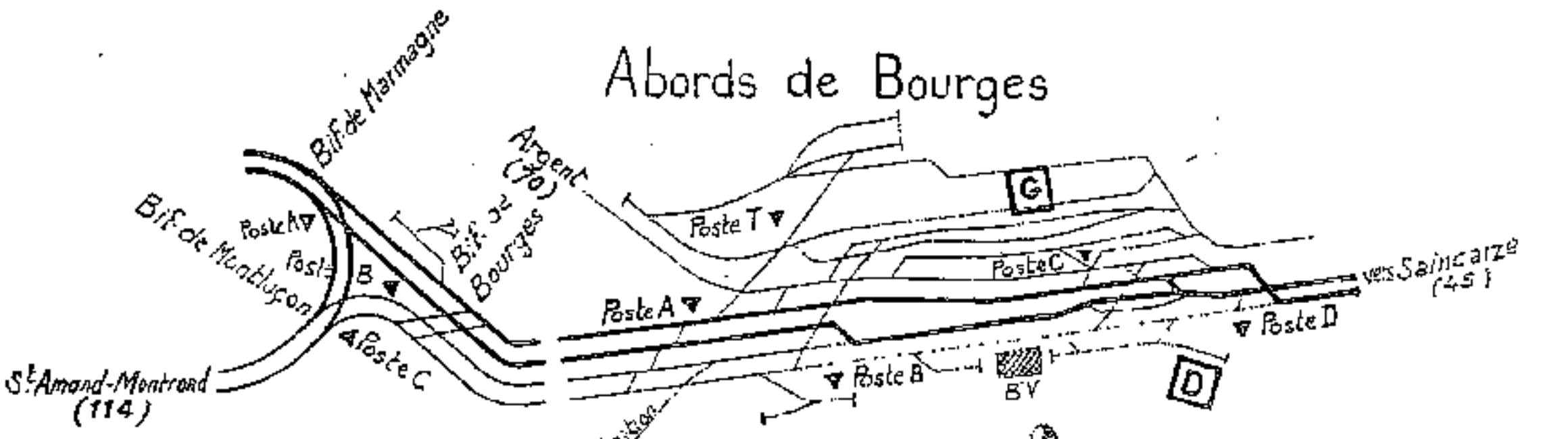

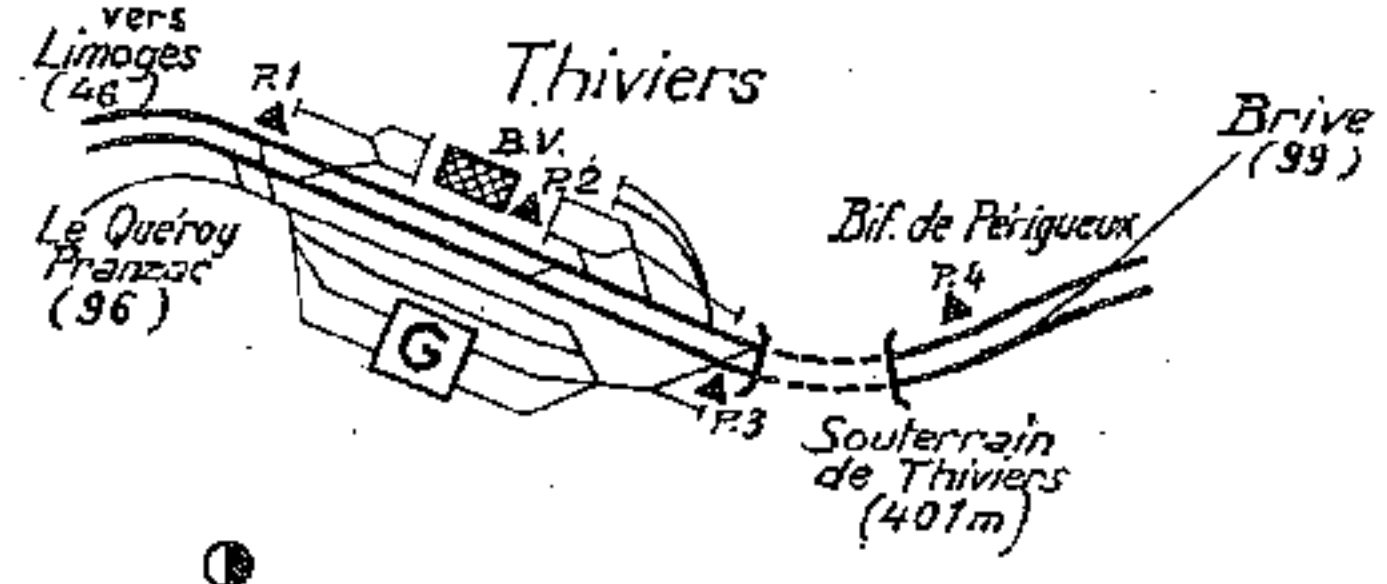

Ligne de Limoges à Périgueux

Section de Thiviers à Périgueux et Raccordement de Coutras

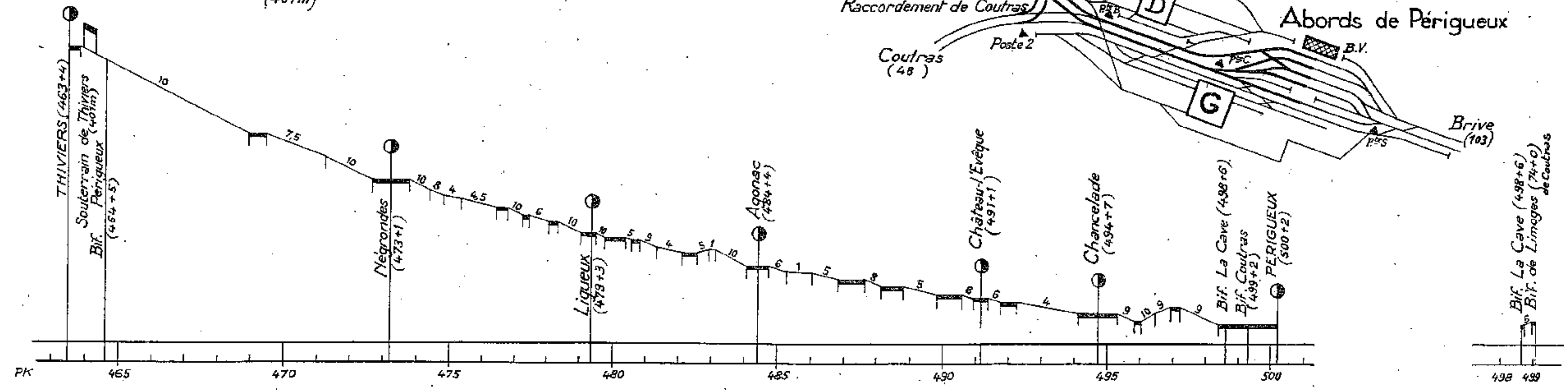
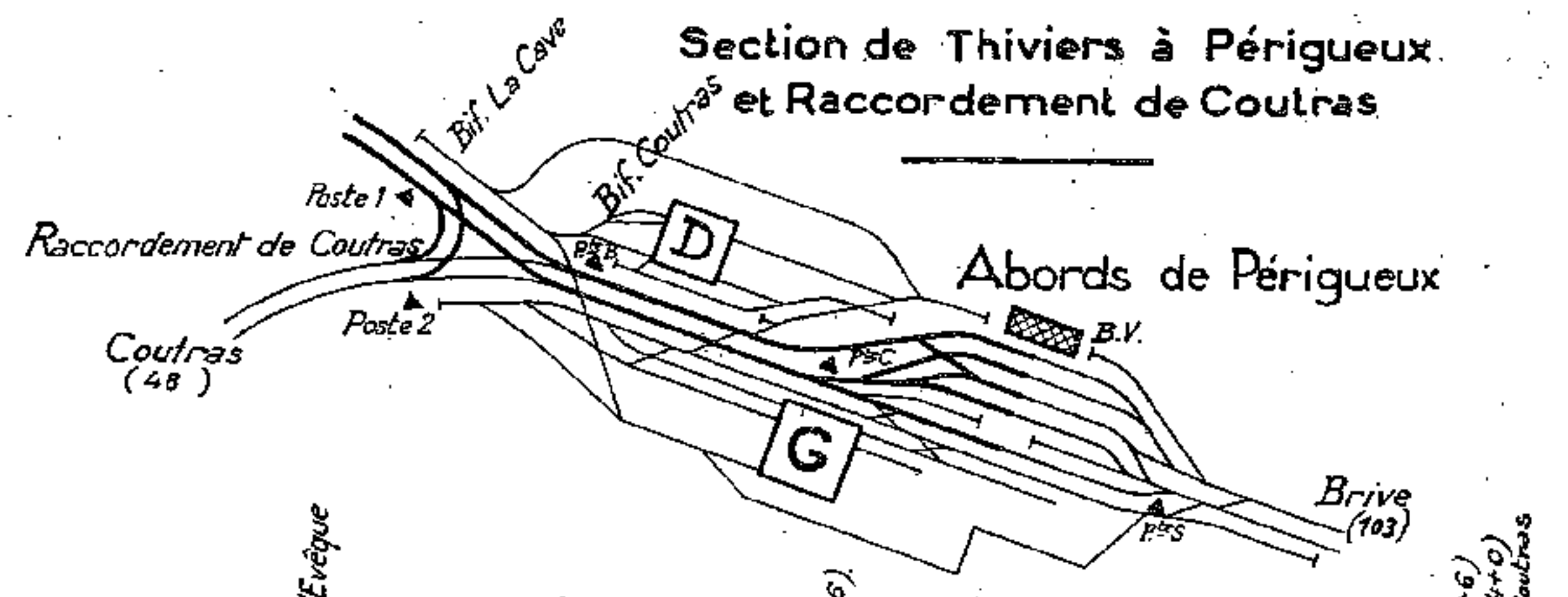

Abords de Limoges (Voir 204)

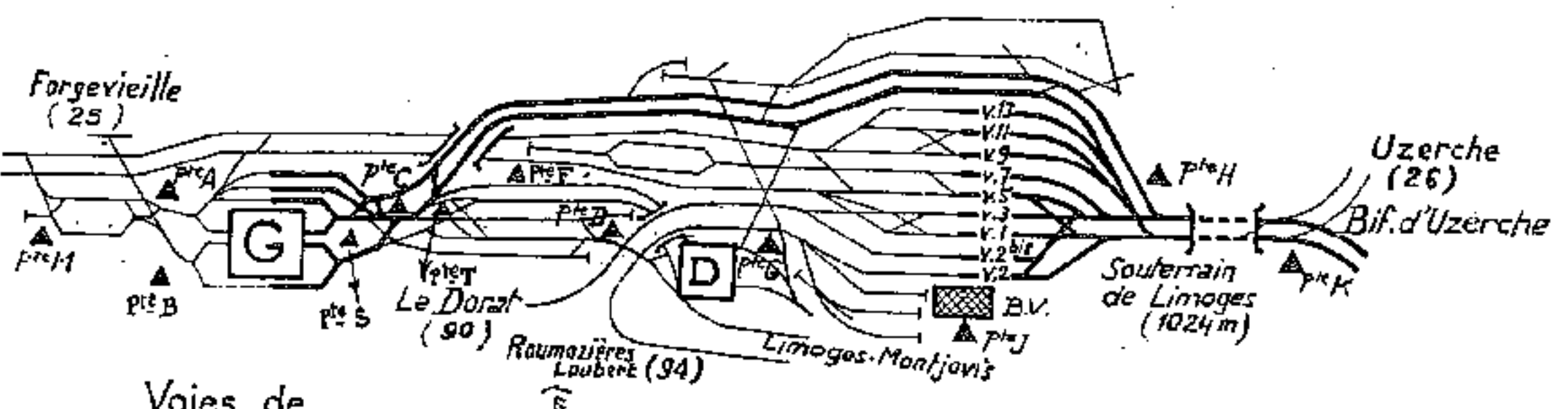

Ligne de Limoges à Périgueux

Section de Limoges à Thiviers

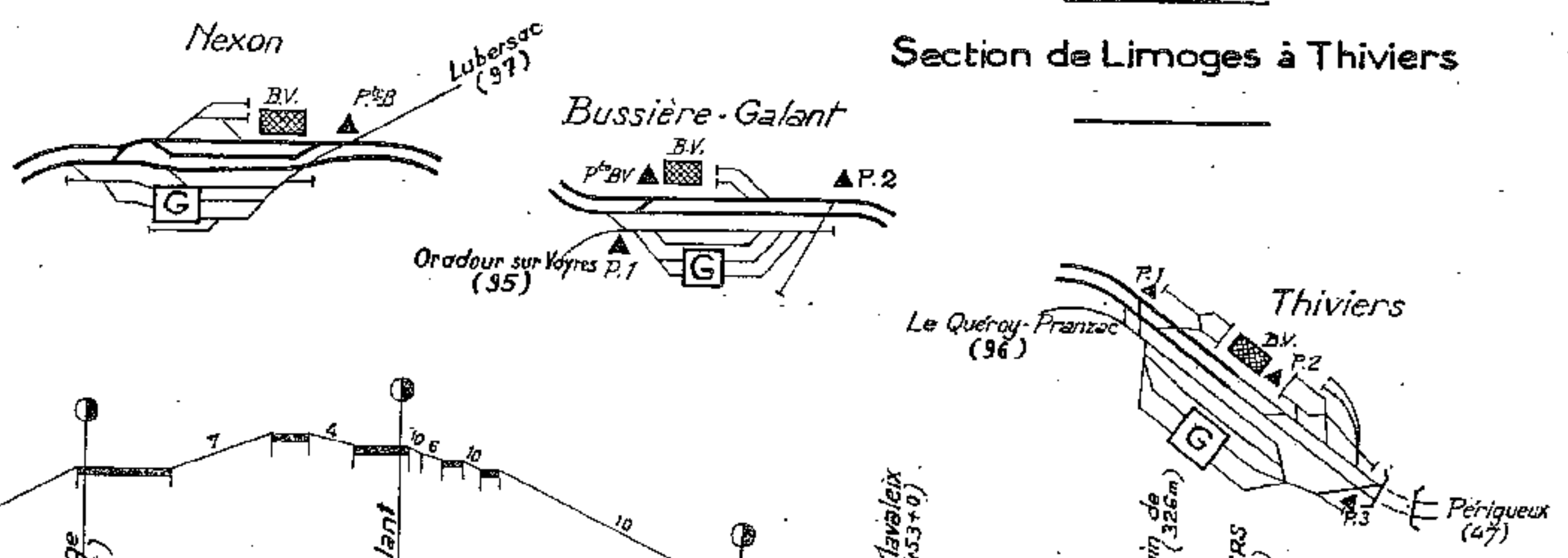

Voies de marchandises

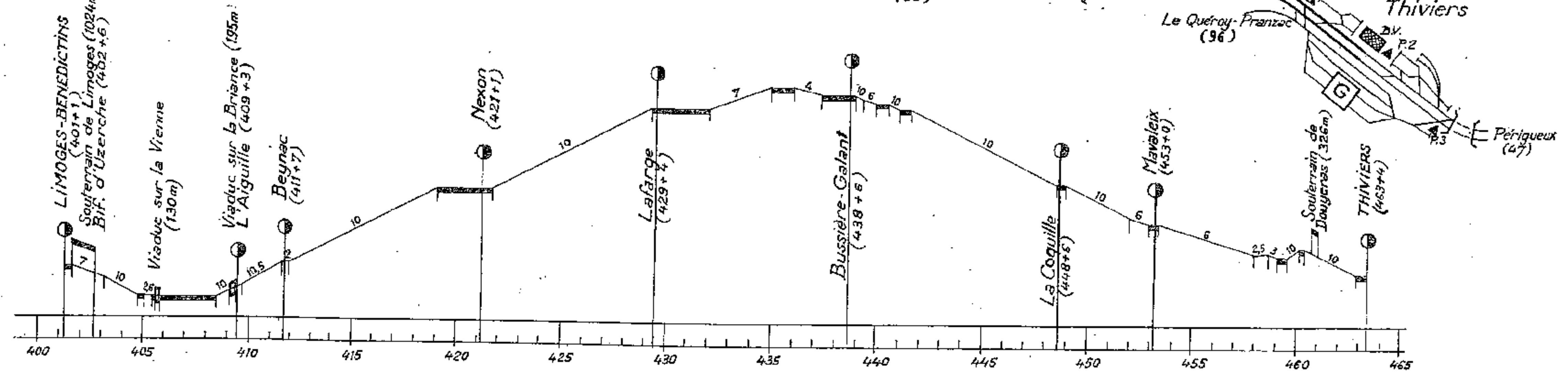
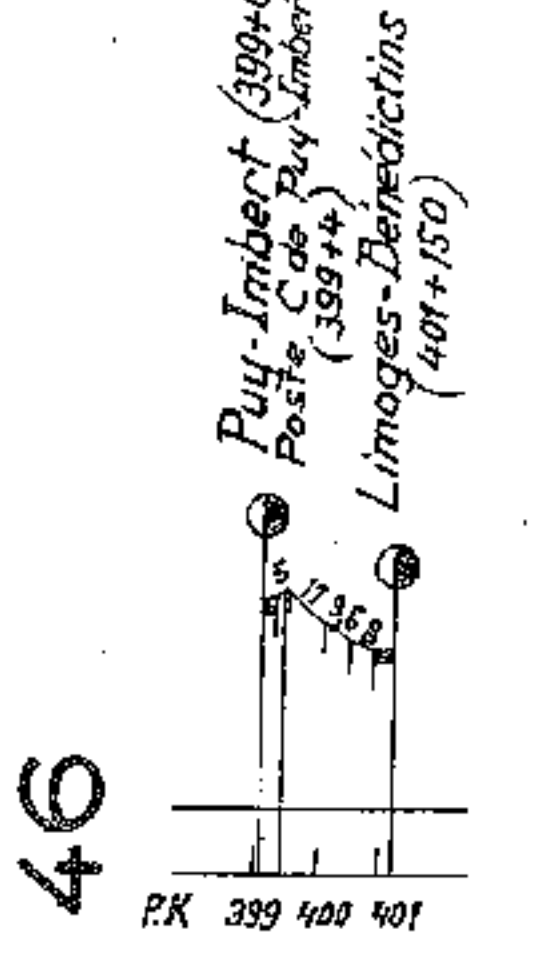

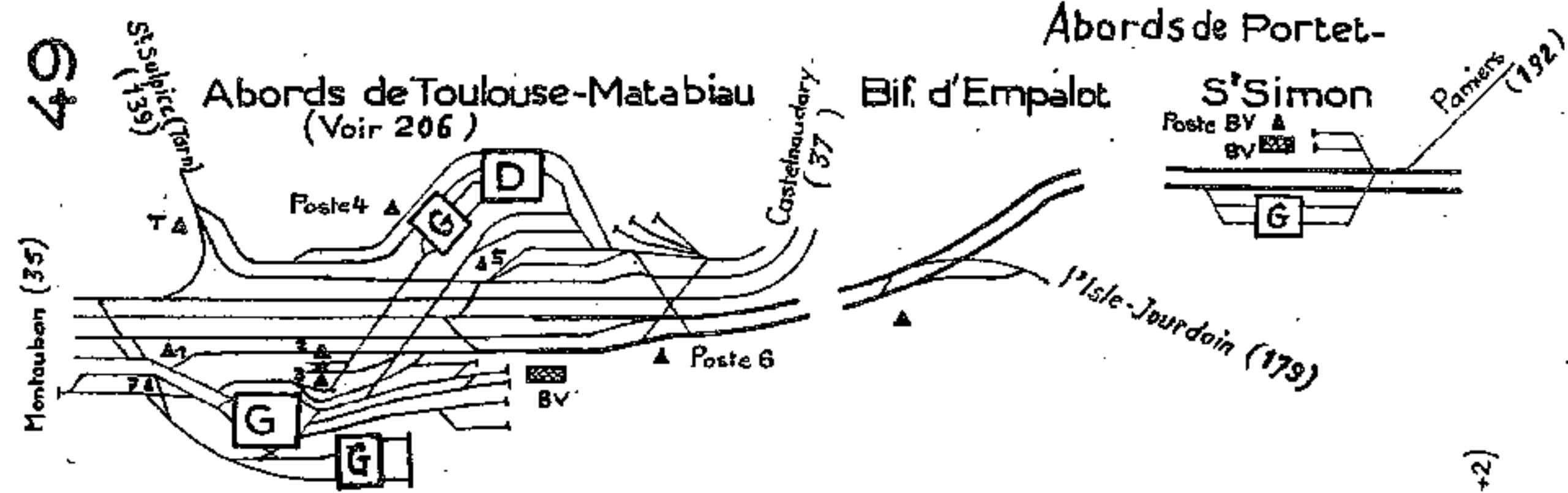

Ligne de Toulouse-Matabiau à Tarbes

Section Toulouse-Matabiau- BousSENS.

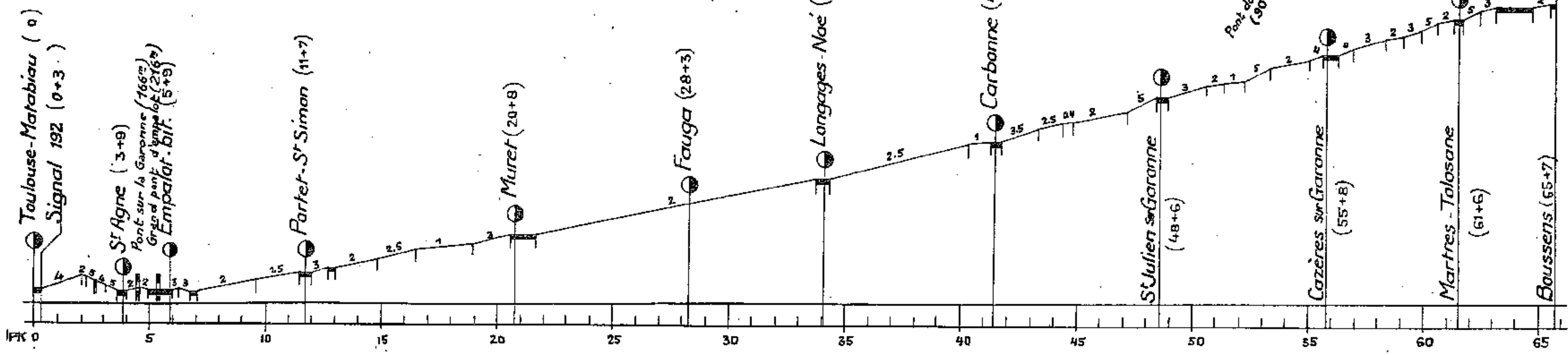

Ligne de Périgueux à Coutras

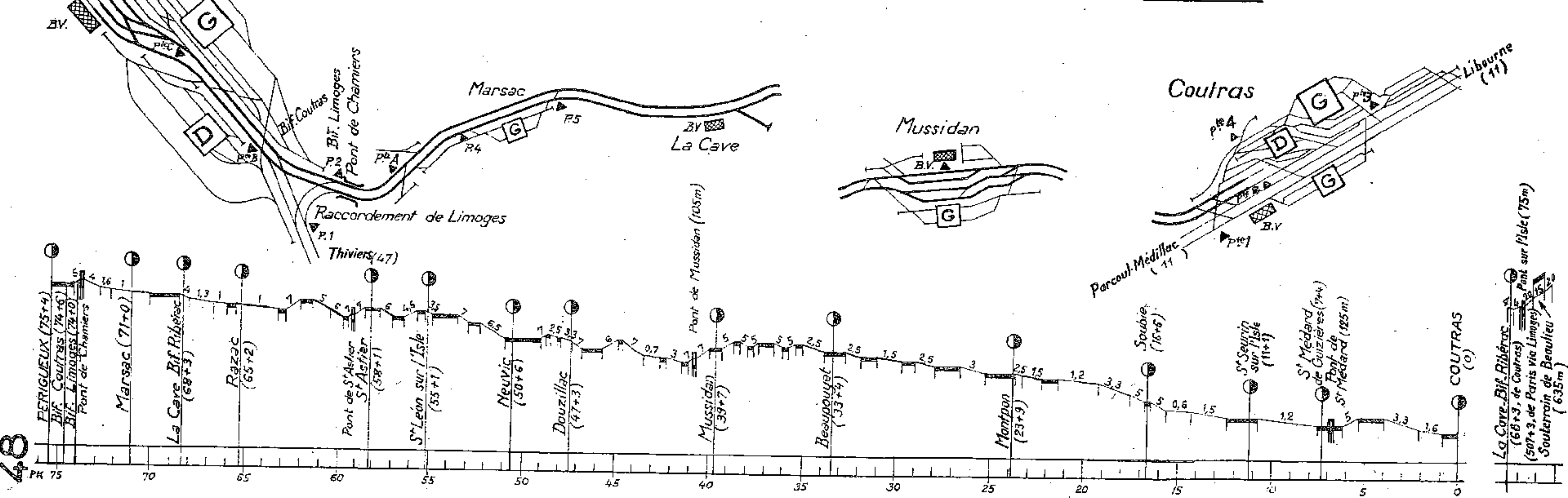

Abords de Montréjeau - Gourdan - Polignan

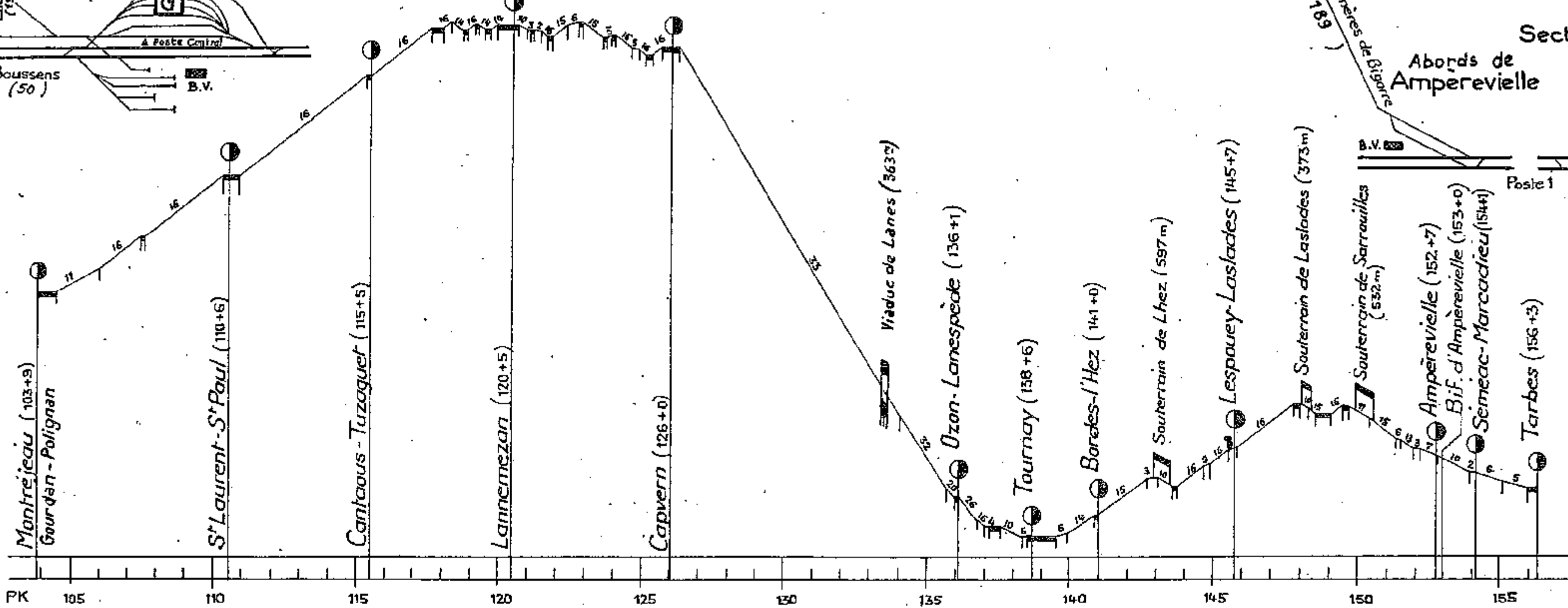
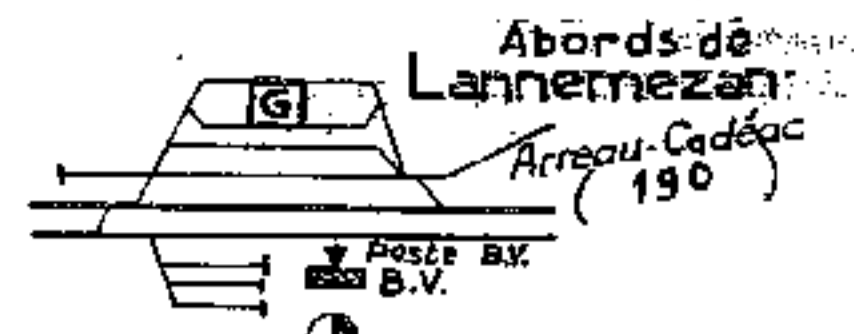
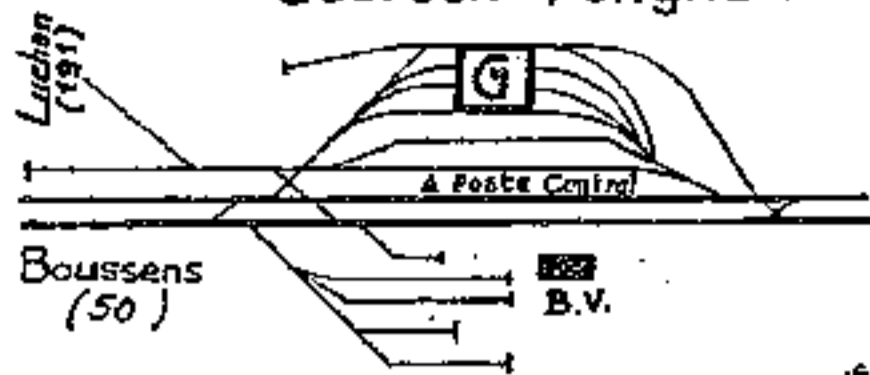

Ligne de Toulouse-Matabiau à Tarbes

Section Montréjeau-Tarbes

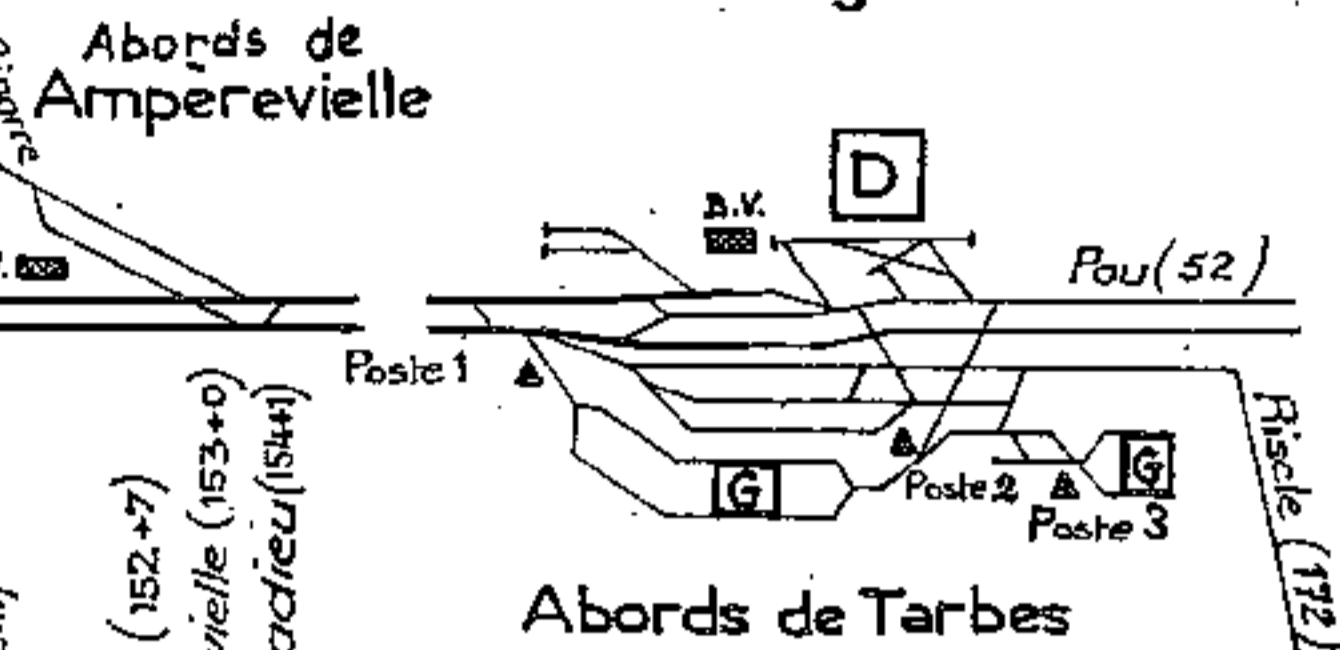

Ligne de Toulouse-Matabiau à Tarbes

Section de Boussens à Montréjeau-Gourdan-Polignan

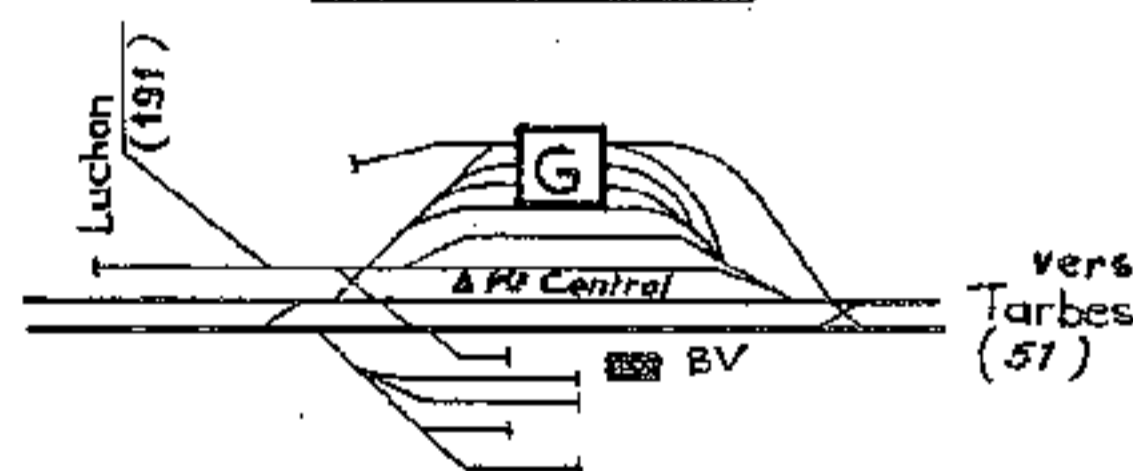
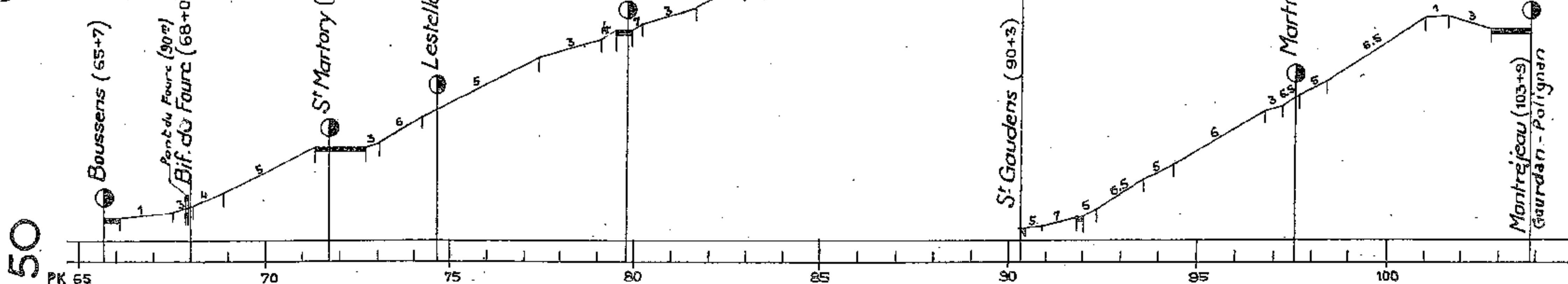
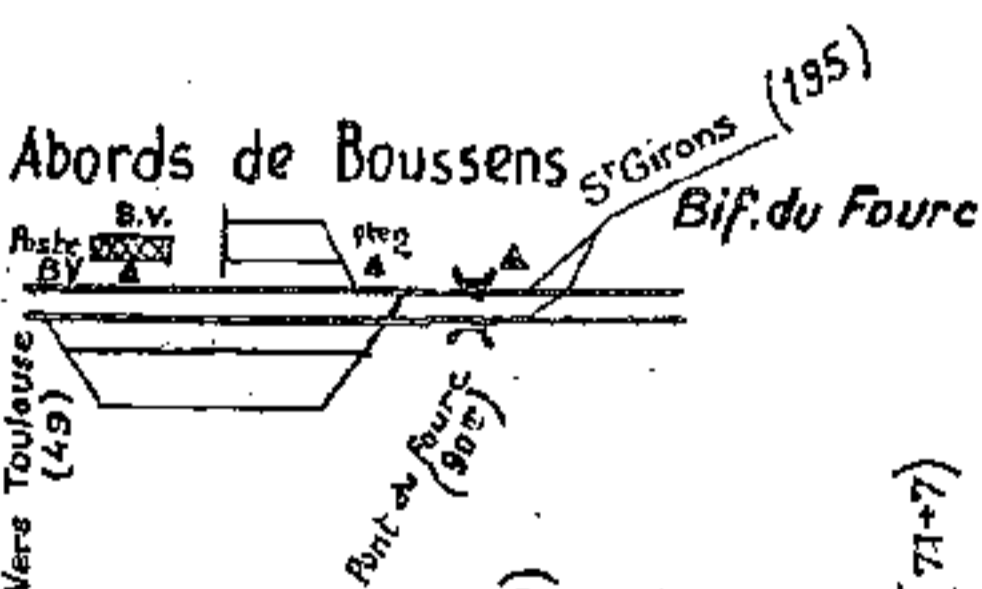

Abords de Montréjeau-Gourdan - Polignan

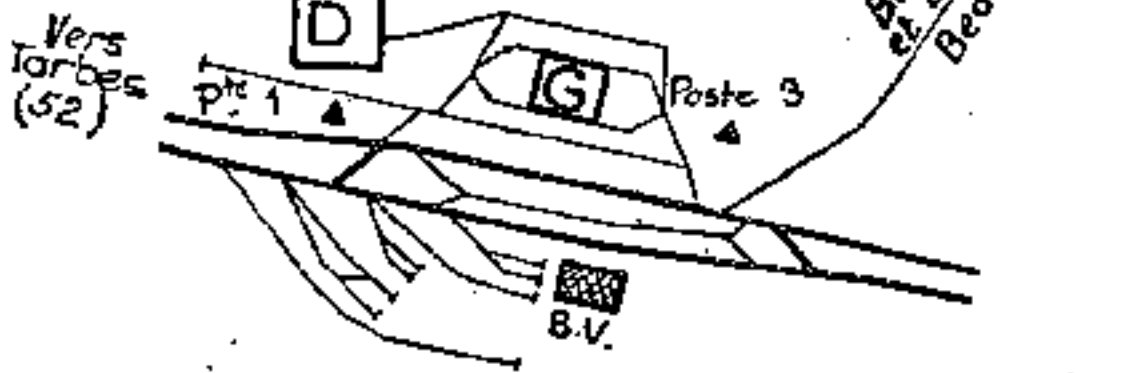

Ligne de Tarbes à Bayonne

Section Pau-Puyôo

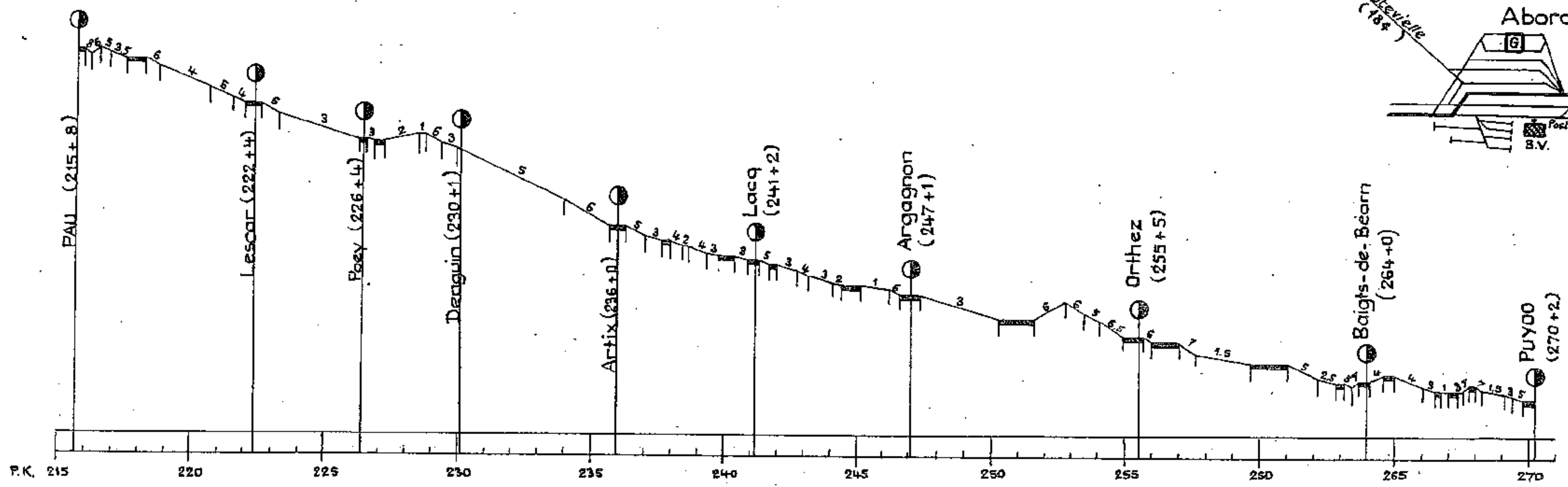
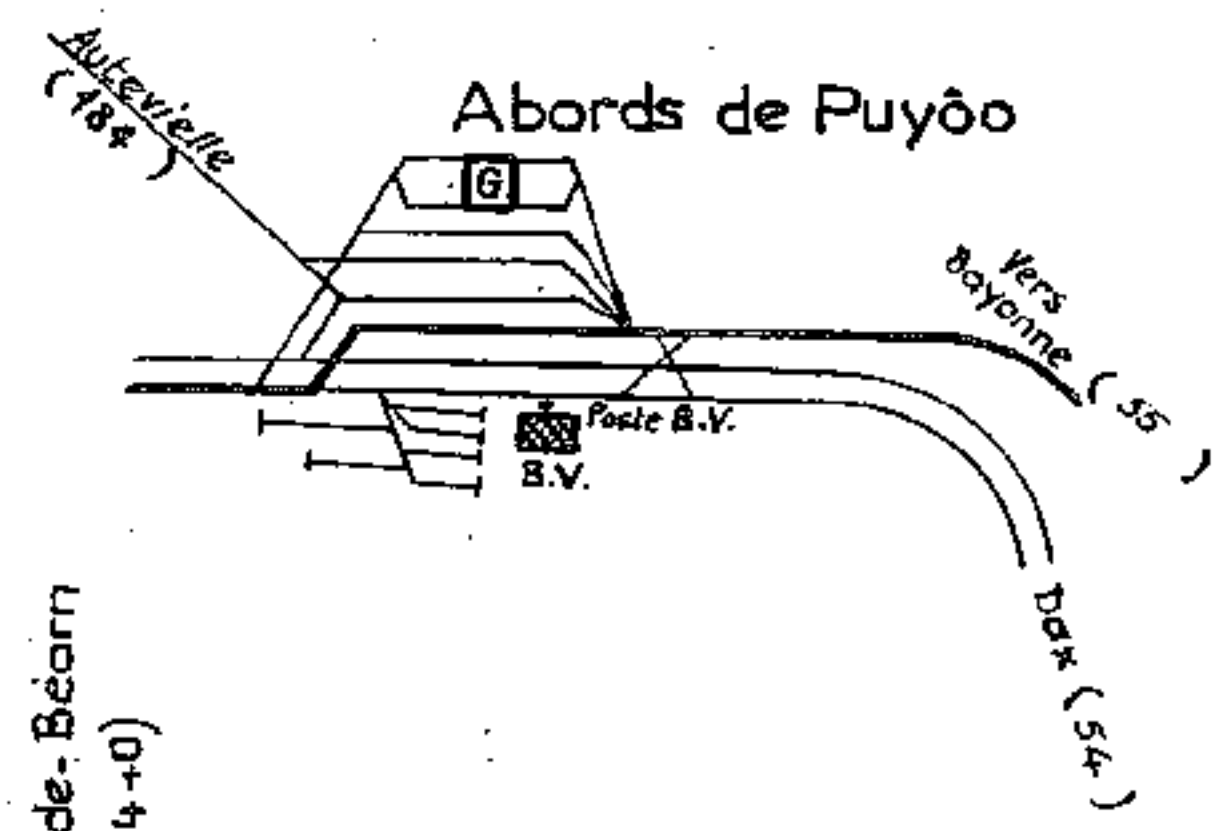

Abords de Tarbes

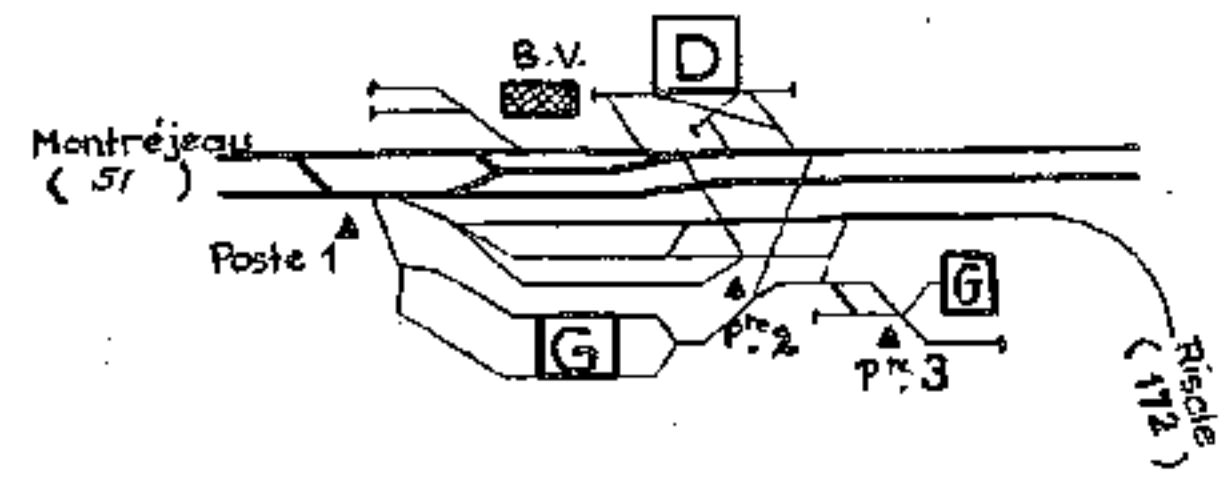

Lourdes

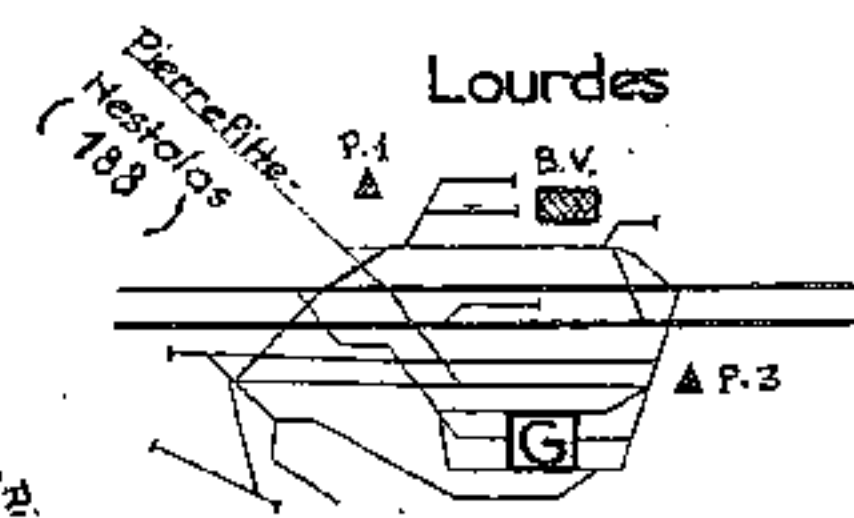

Ligne de Tarbes à Bayonne

Section Tarbes-Pau

Abords de Pau

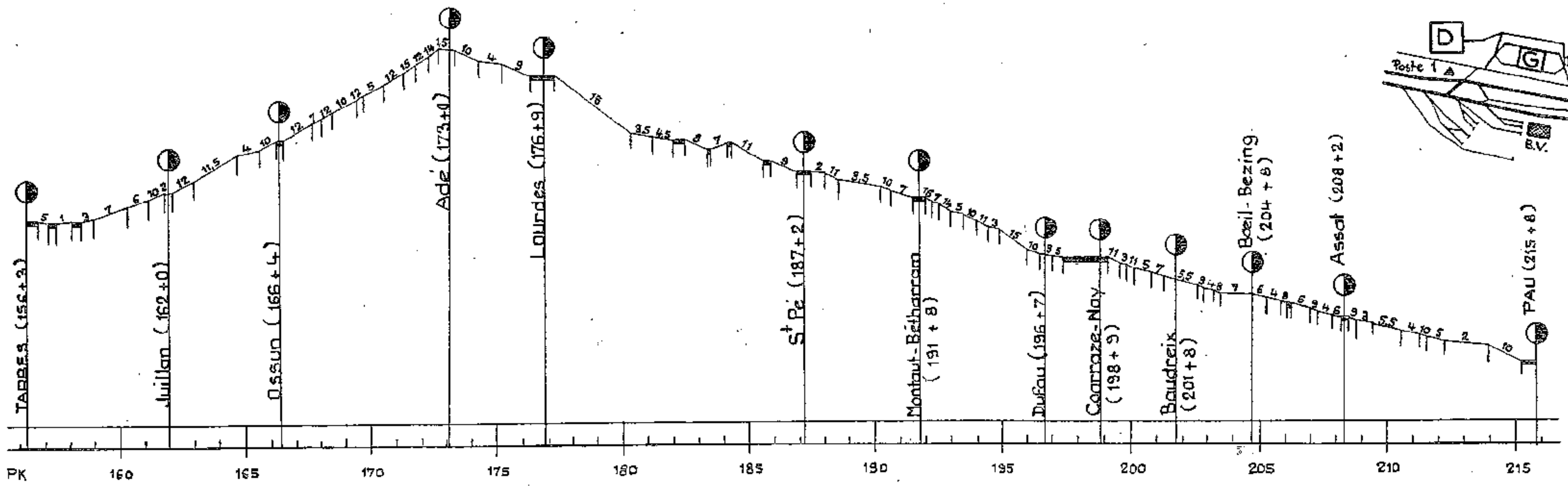
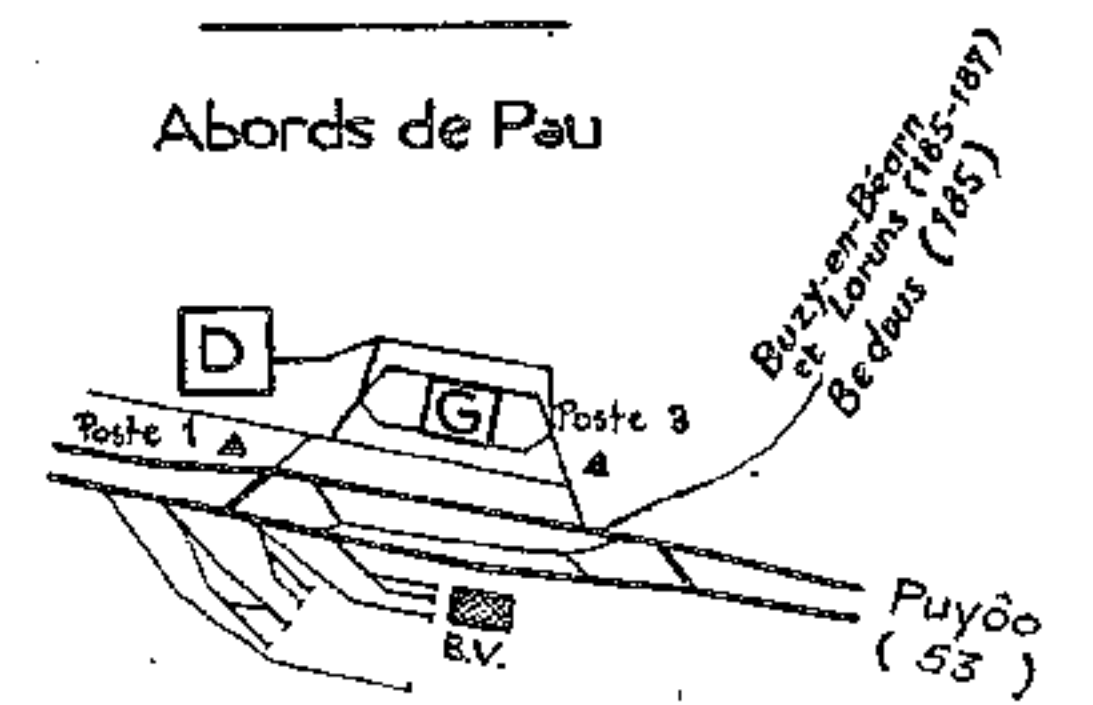

55

Abords de Puyôo

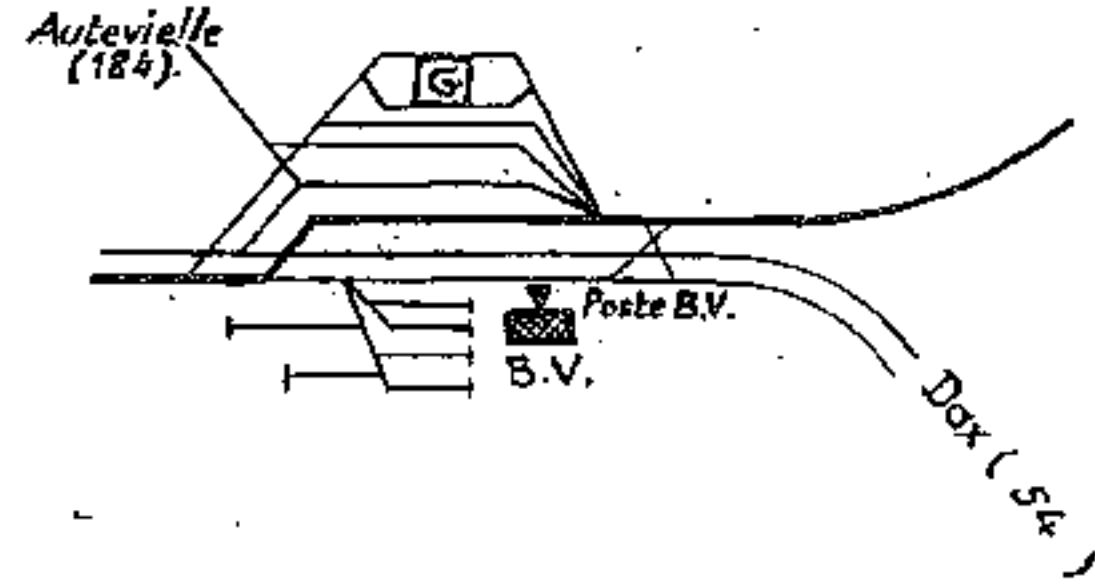

Ligne de Tarbes à Bayonne

Section Puyôo-Bayonne

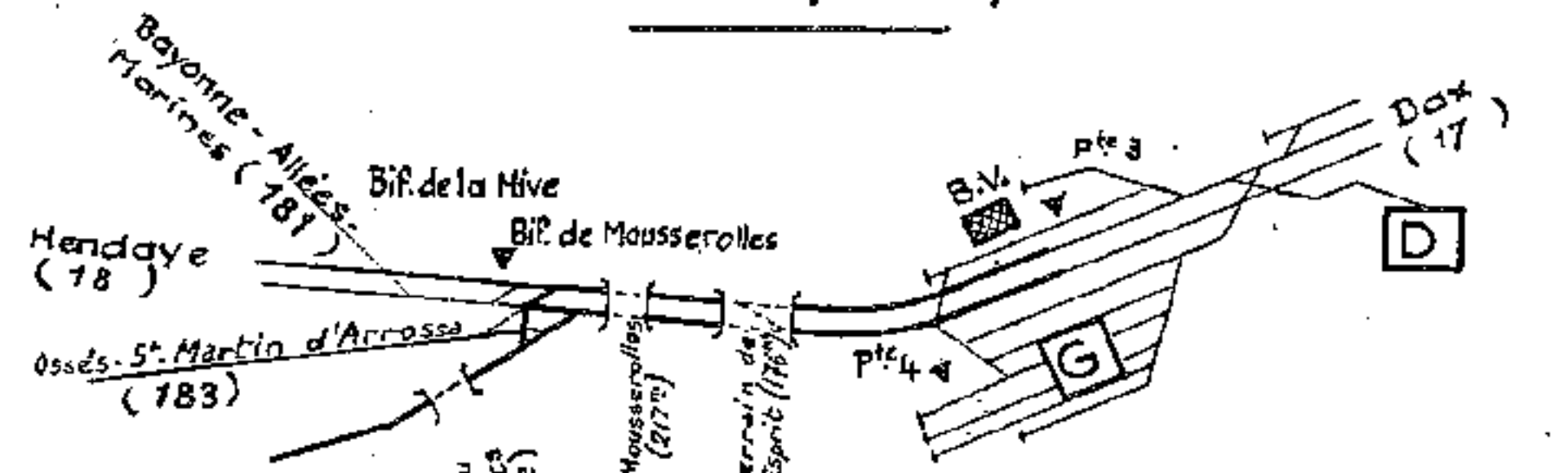
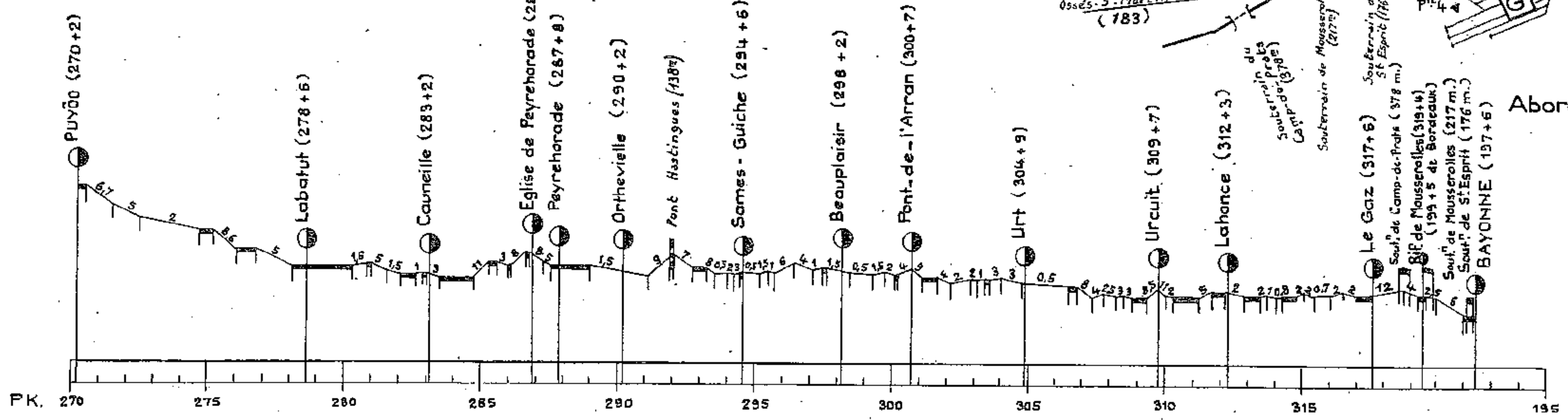

Abords de Bayonne

Abords de Puyôo

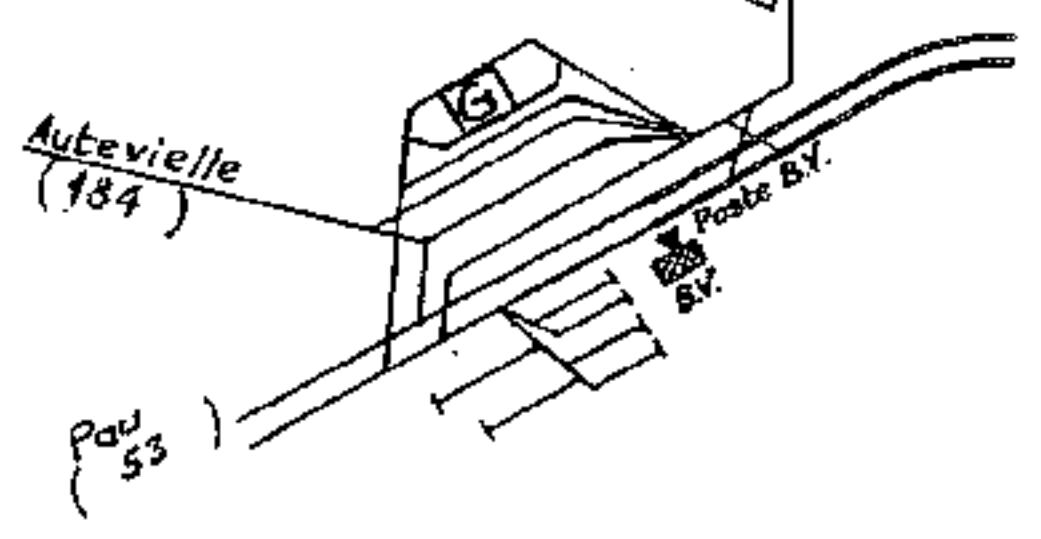

Ligne de Puyôo à Dax

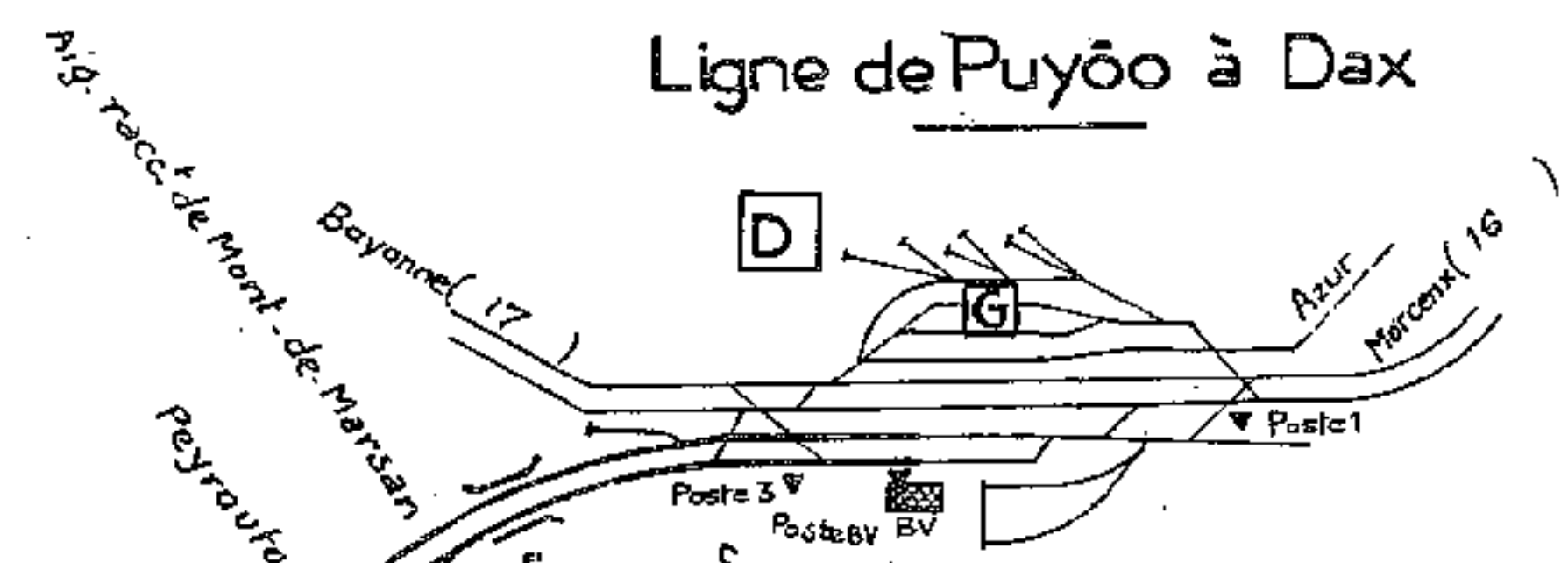
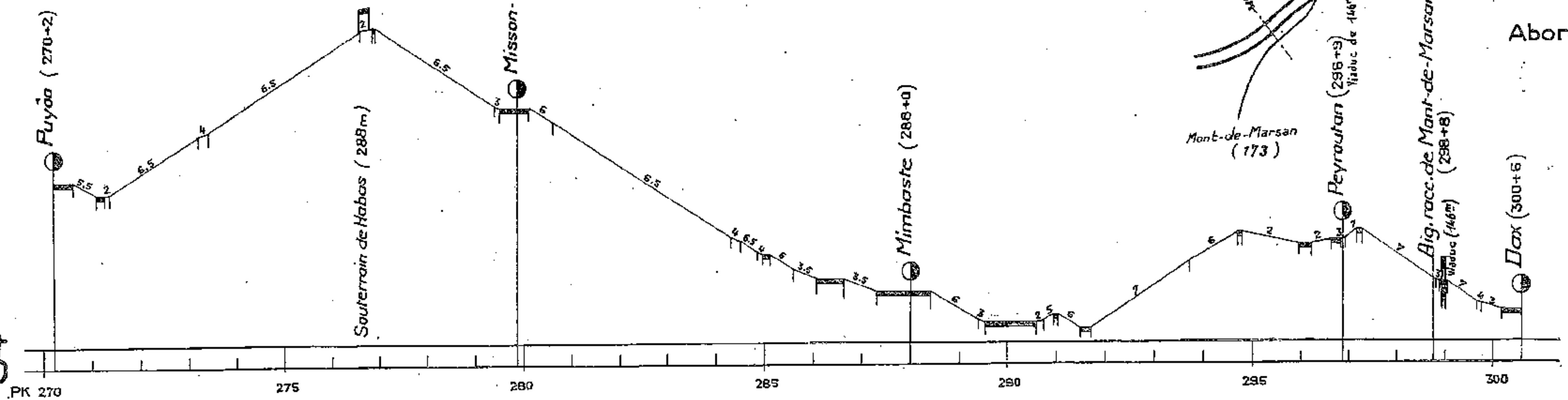

Abords de Dax

54

Ligne de Brétigny à Tours

Section de Brétigny à Auneau

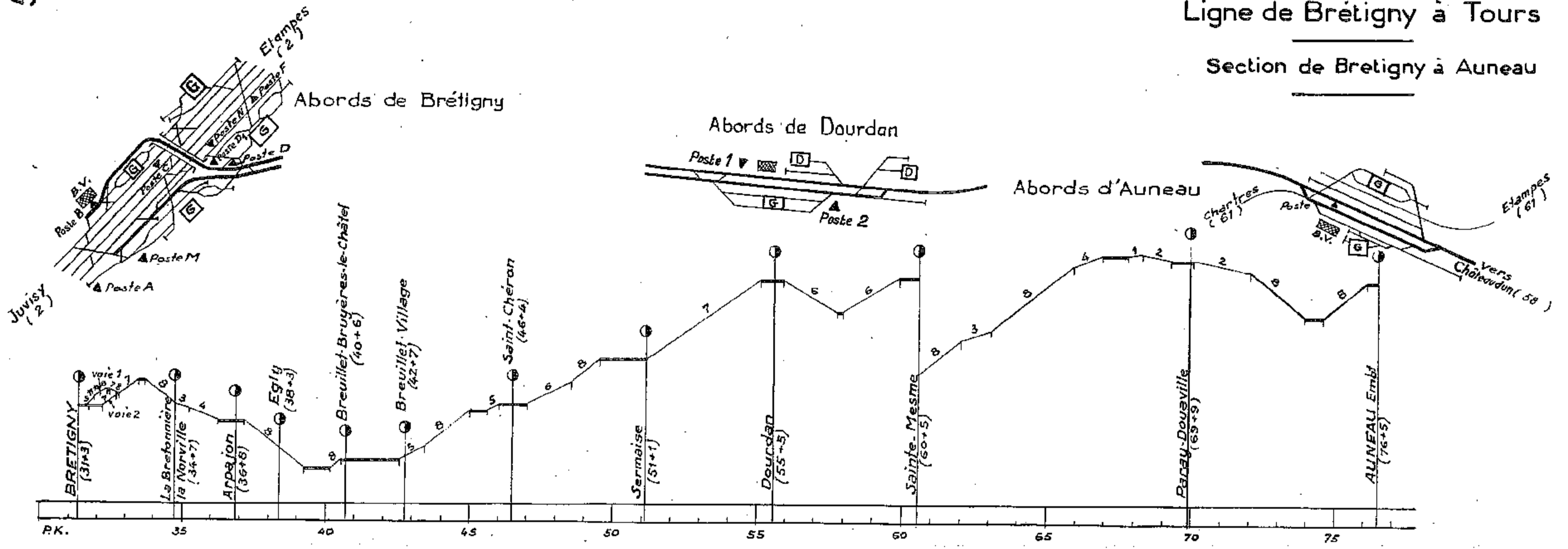

Ligne de Malesherbes à Orléans

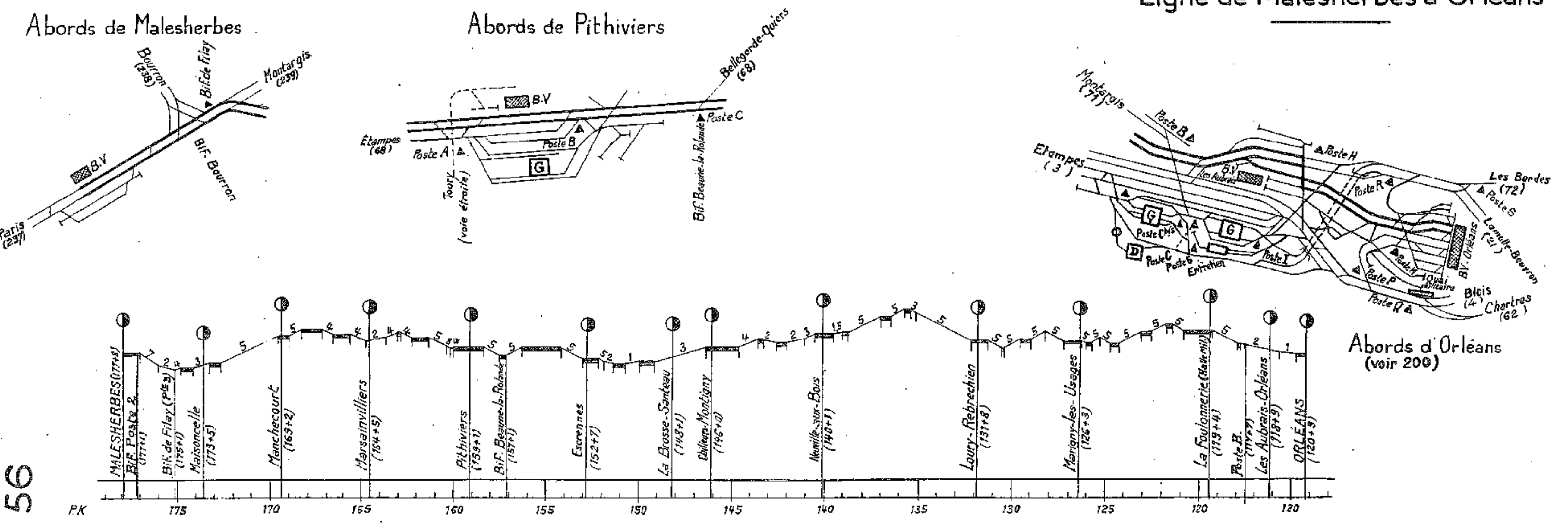

Abords de Châteaudun

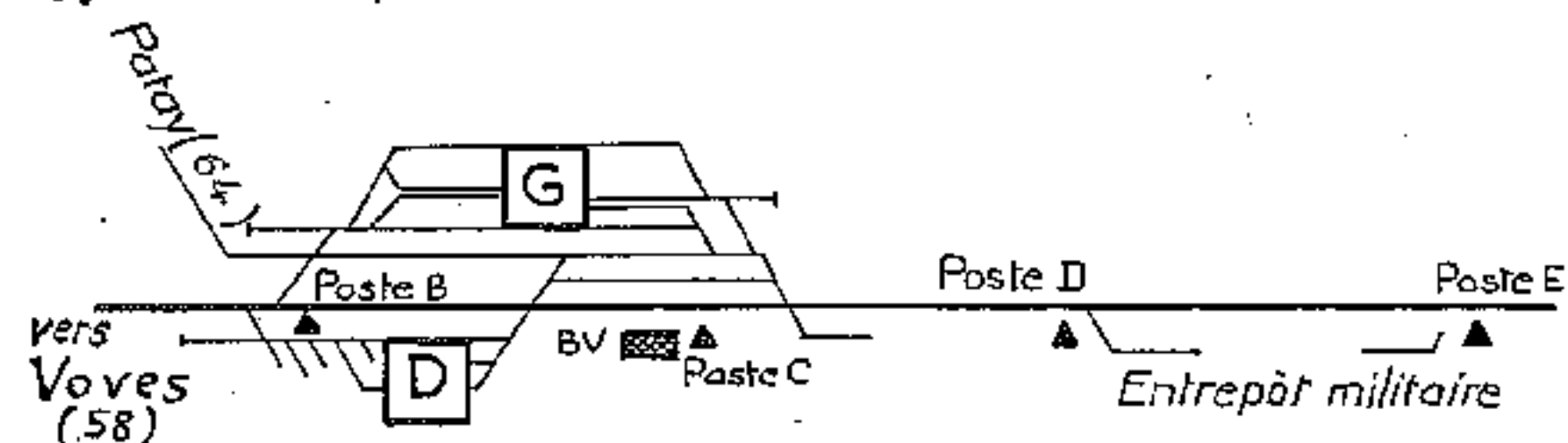

Abords de Vendôme Ligne de Brétigny à Tours

Section de Châteaudun à St Amand de Vendôme

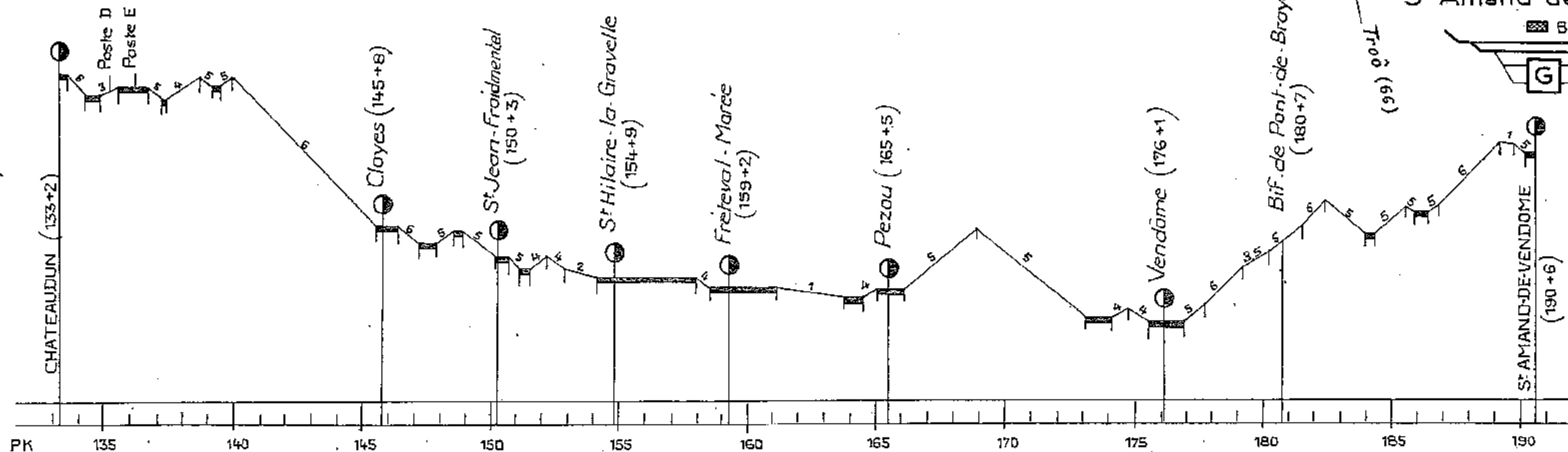

Ligne de Brétigny à Tours

Section d'Auneau à Châteaudun

Abords d'Auneau Embt

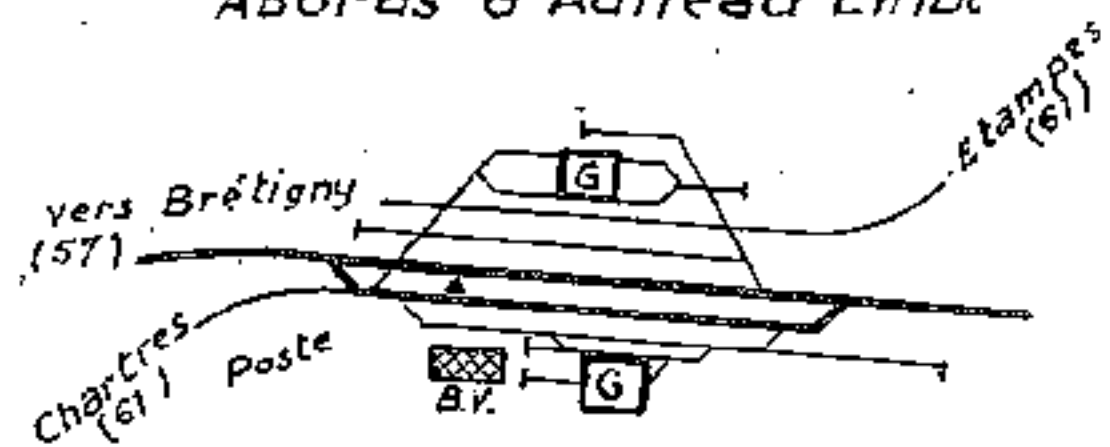

Abords de Voves

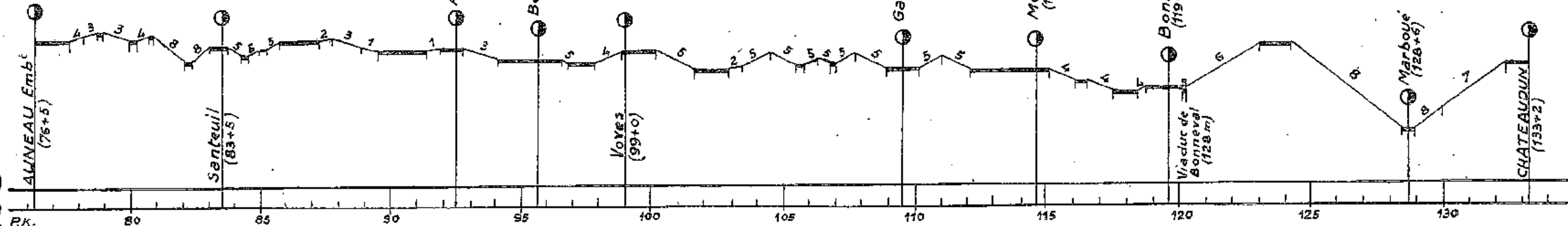
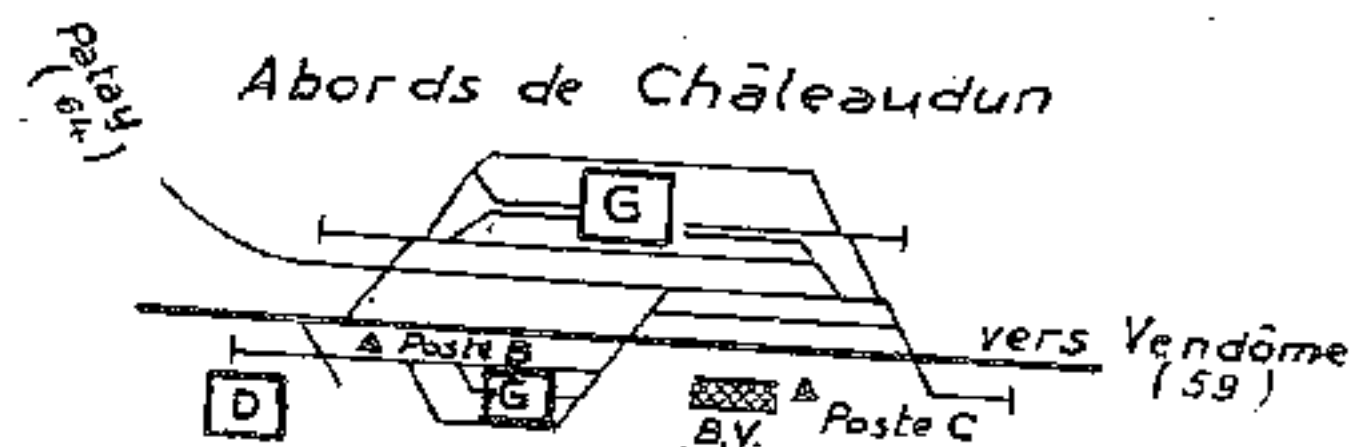
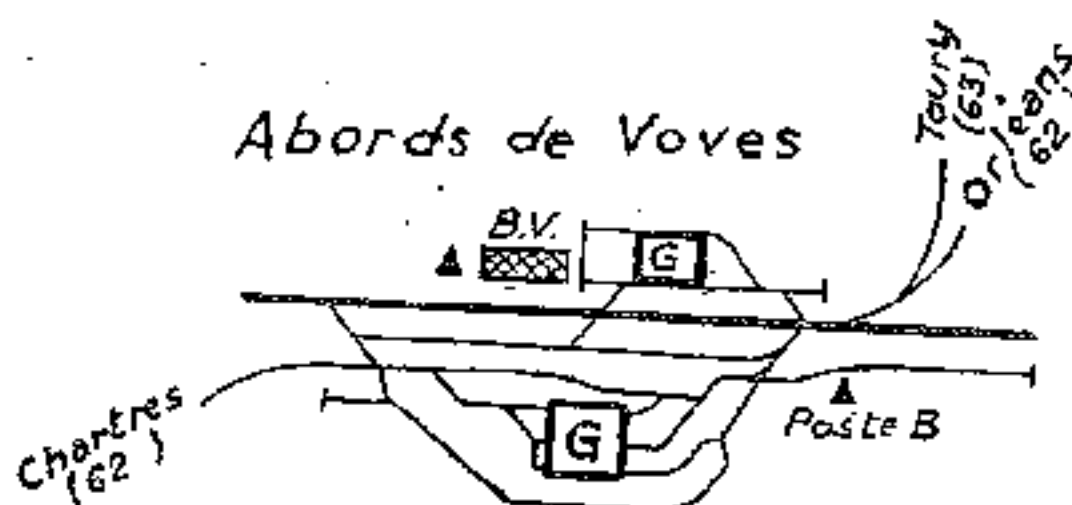

Ligne d'Etampes à Auneau et Chartres

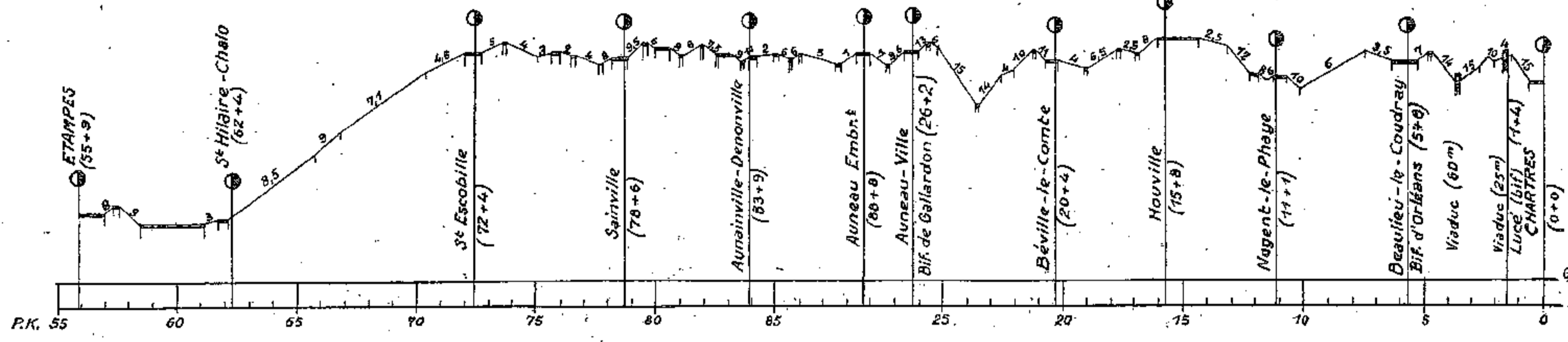
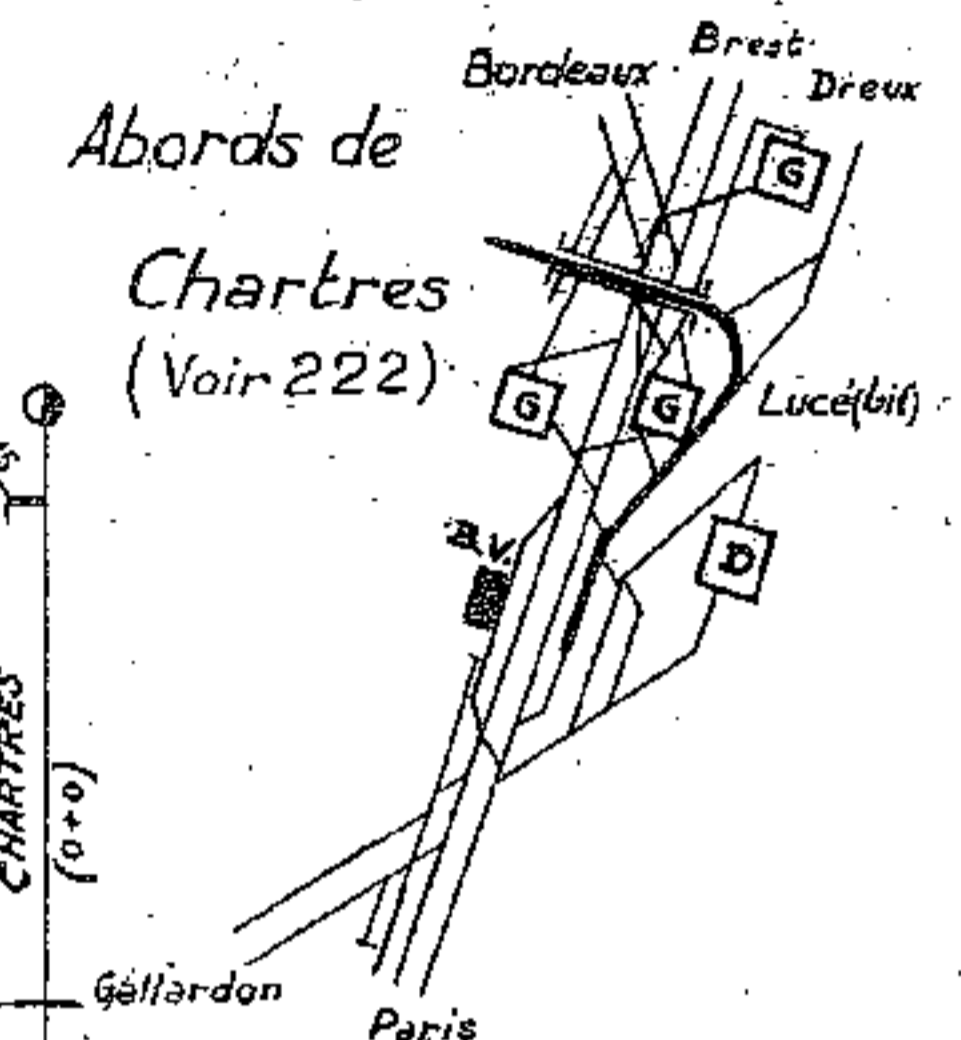
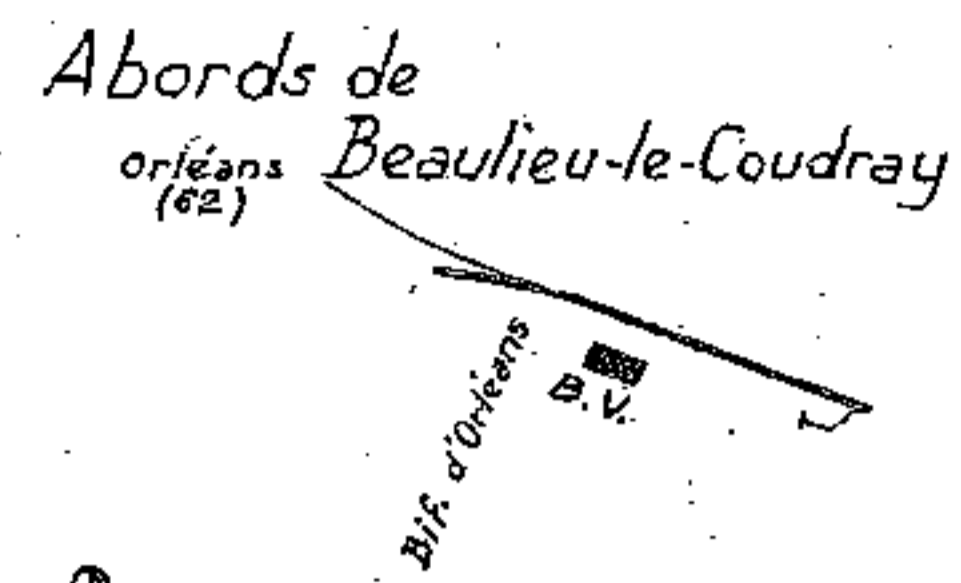
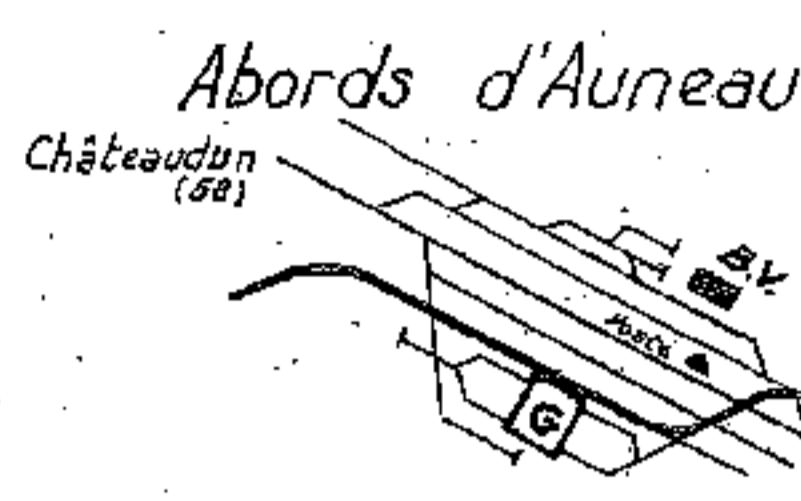
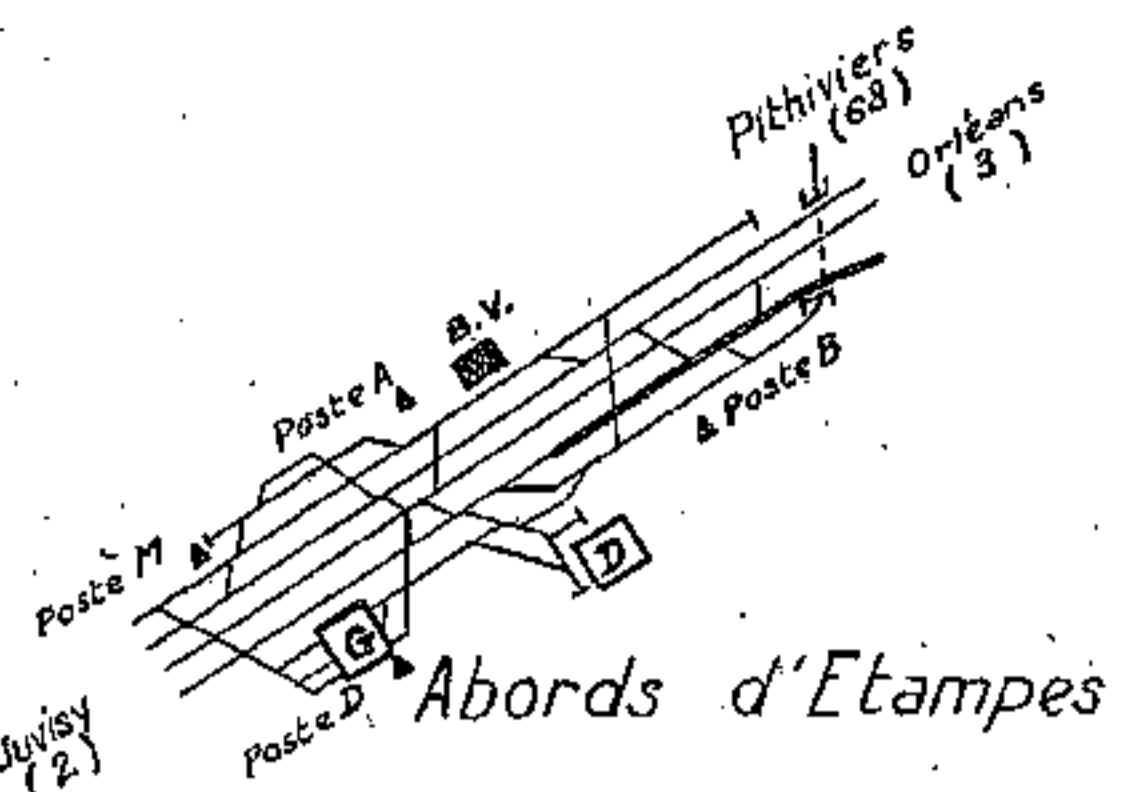

Abords de St-Amand de Vendôme

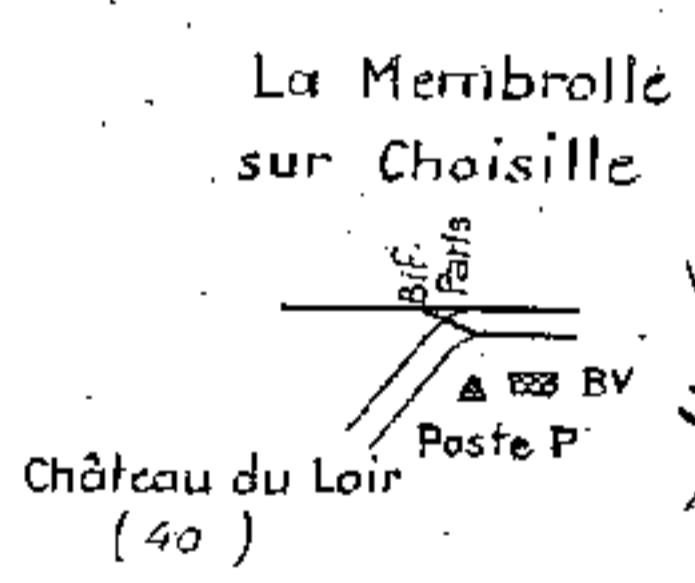
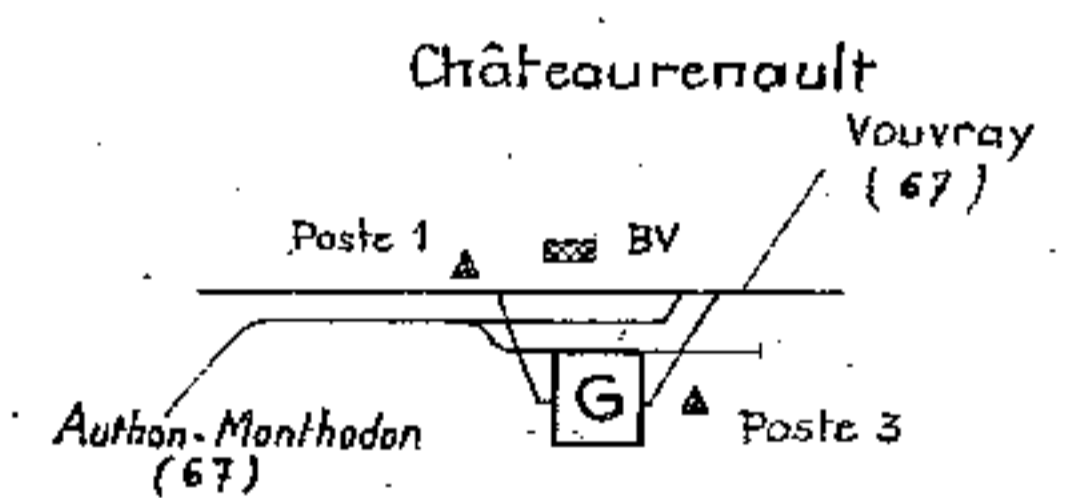
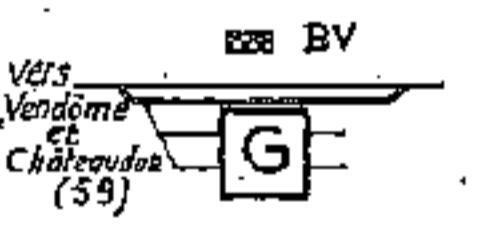

Abords de Tours St-Pierre (voir 201)

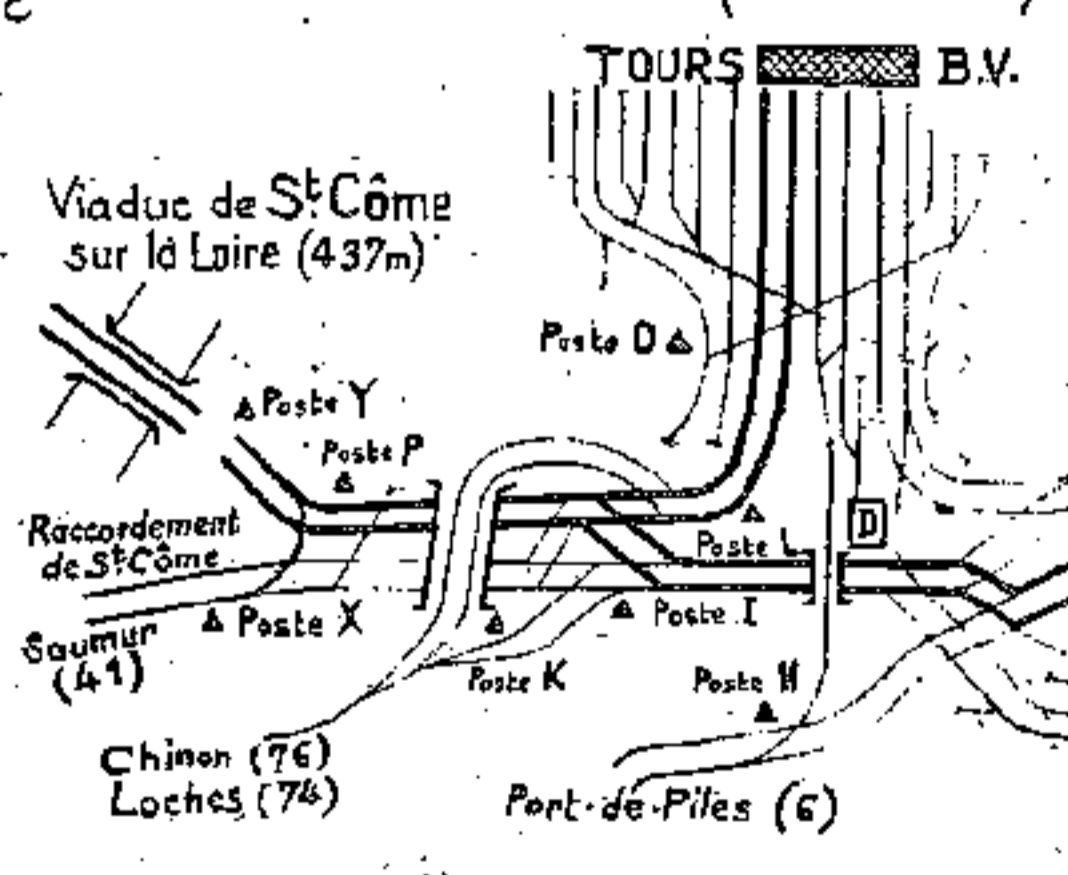

Ligne de Brétigny à Tours Section de St-Amand de Vendôme à Tours-St-Pierre (et raccordement de St-Côme)

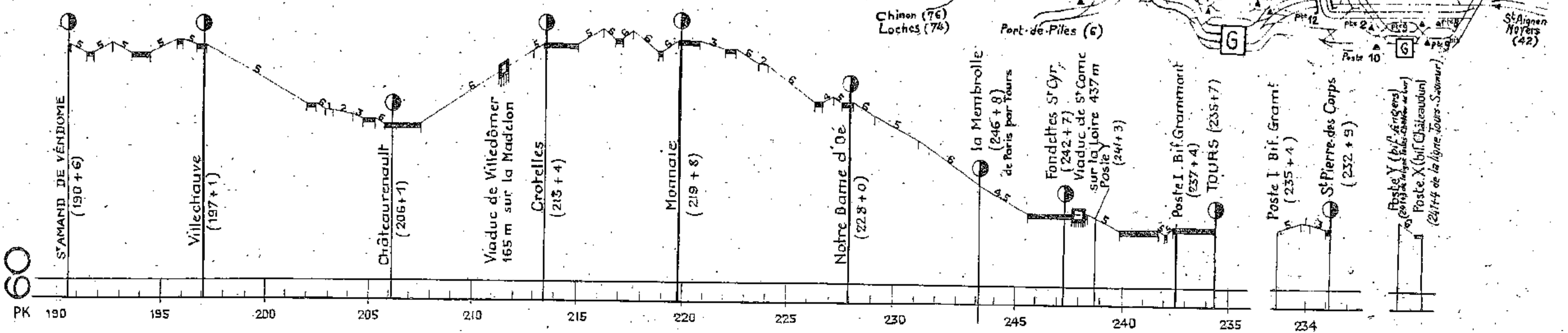
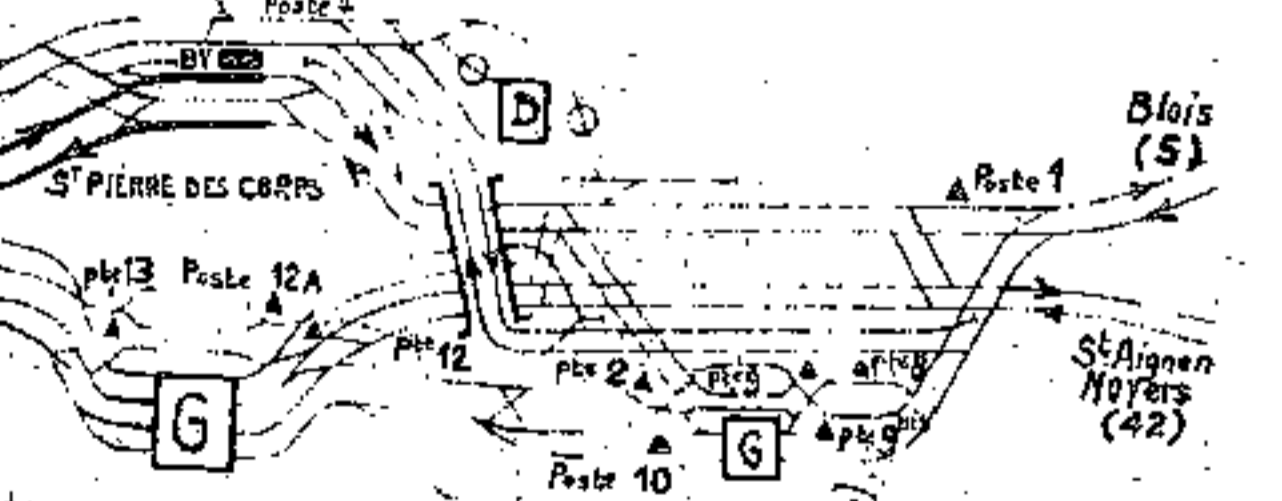

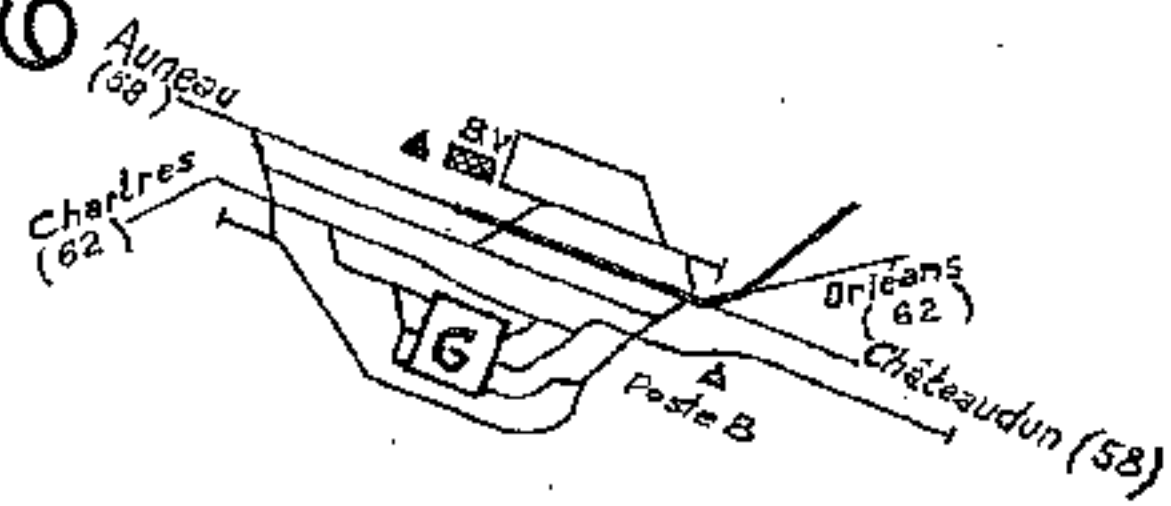

Abords de Vouves

Ligne de Vouves à Toury

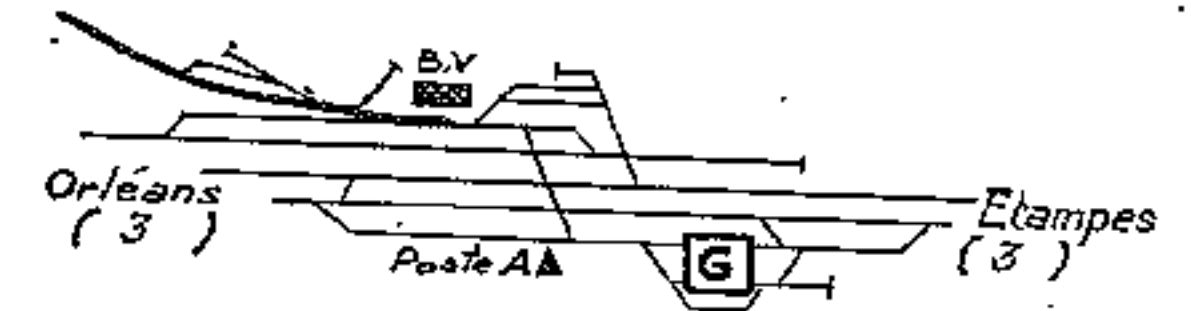

Abords de Toury

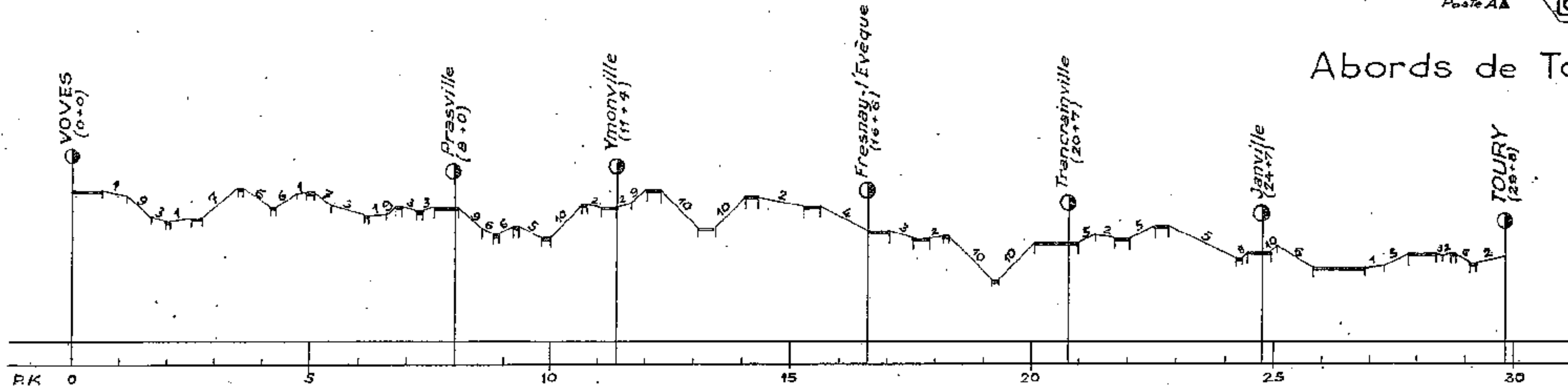

Ligne de Chartres à Orléans

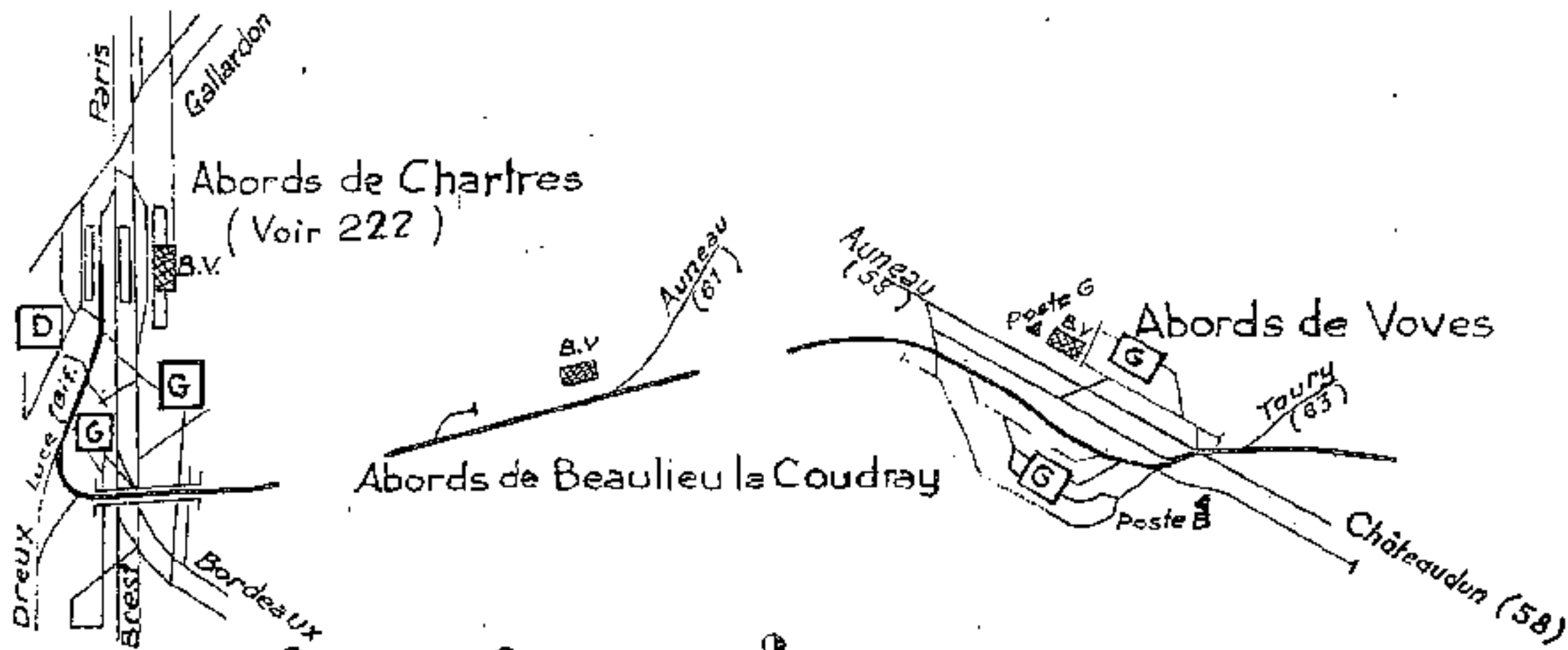

Abords de Chartres (Voir 222)

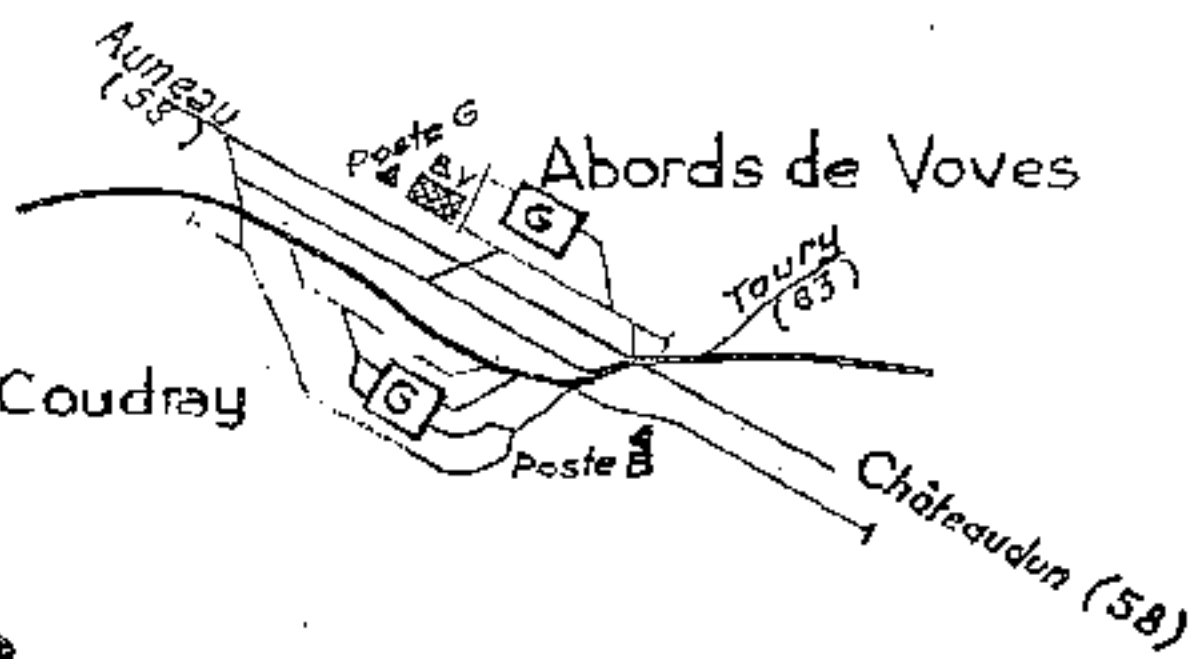

Abords de Vouves

Abords de Beaulieu la Coudray

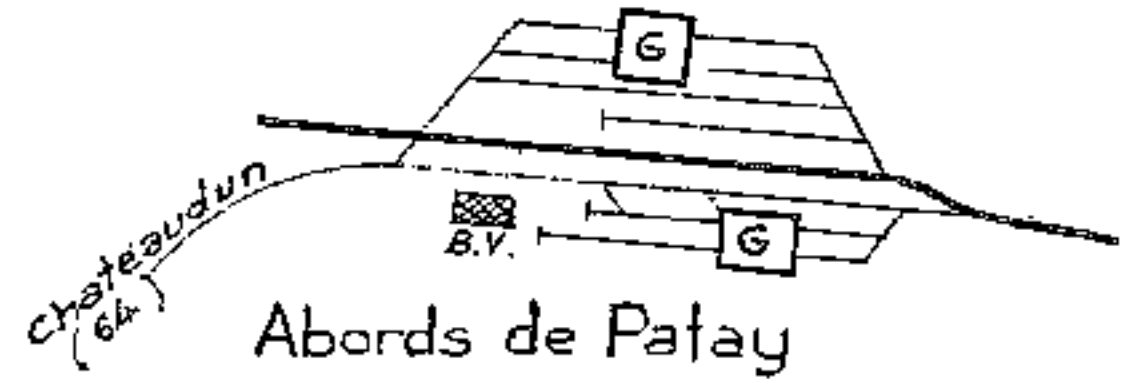

Abords de Patay

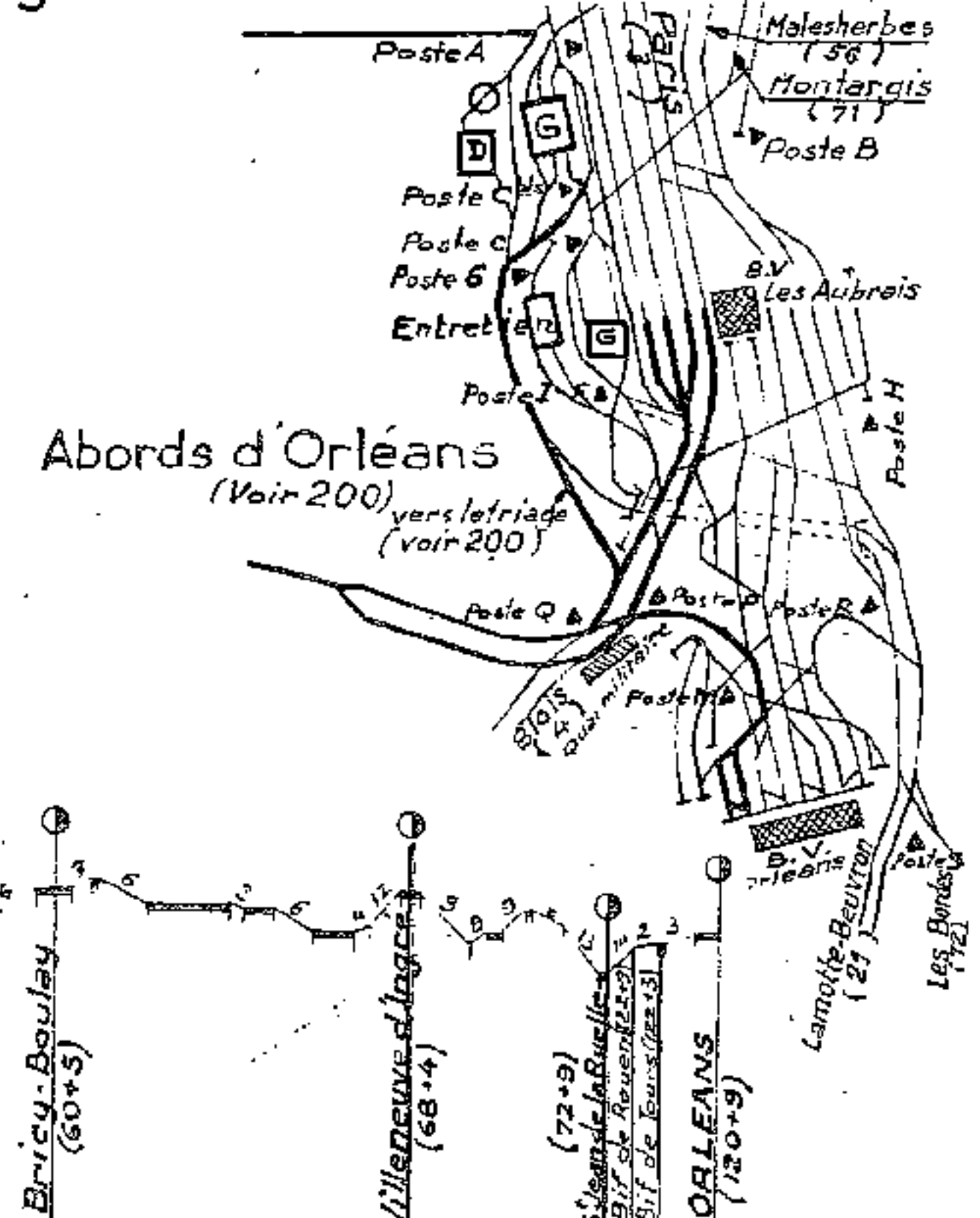

Abords d'Orléans (Voir 200) vers le triage (voir 200)

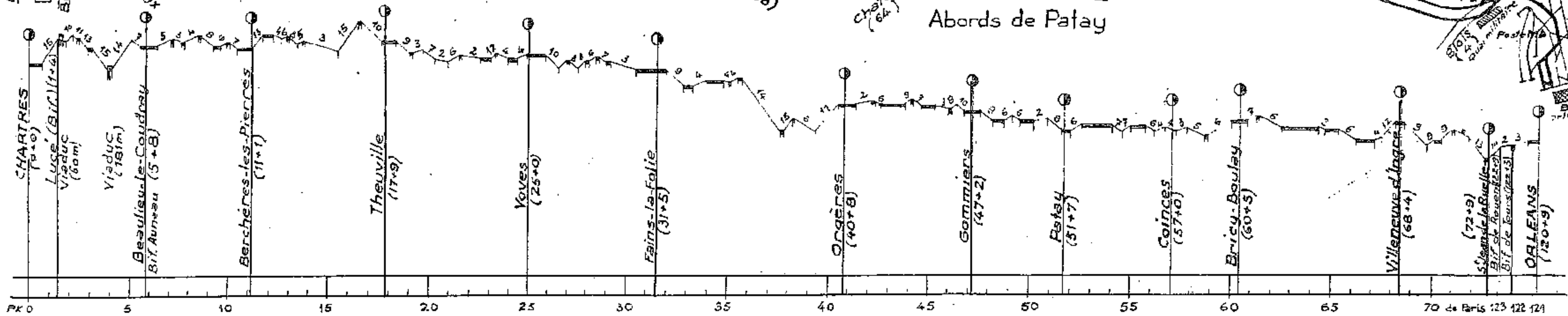

70 de Paris 123 122 121

Abords de Blois

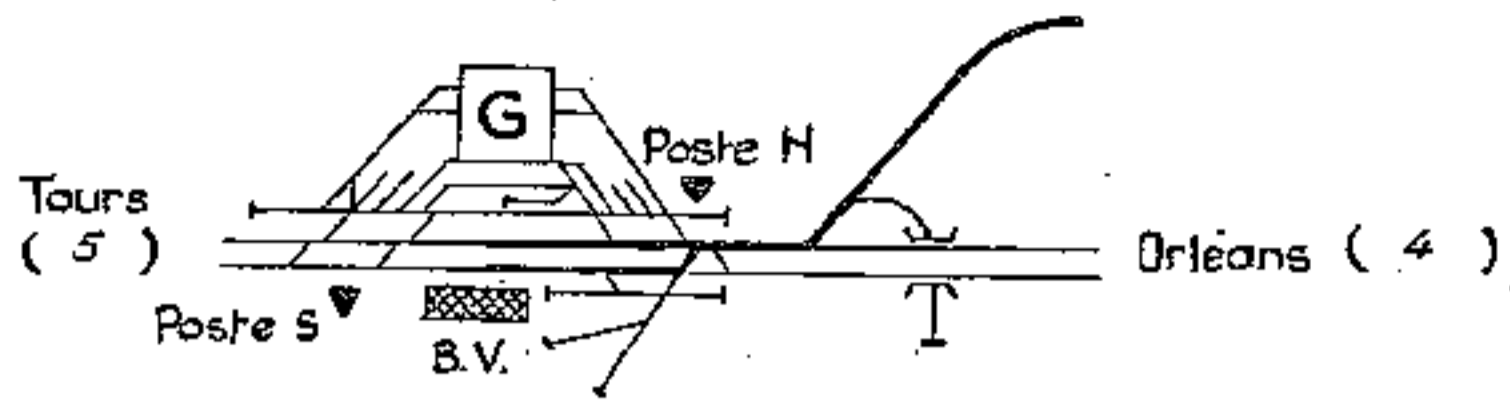

Ligne de Blois à Troô

Sections de Blois à Villefrancoeur et de Selommes à Vendôme

Abords de Vendôme

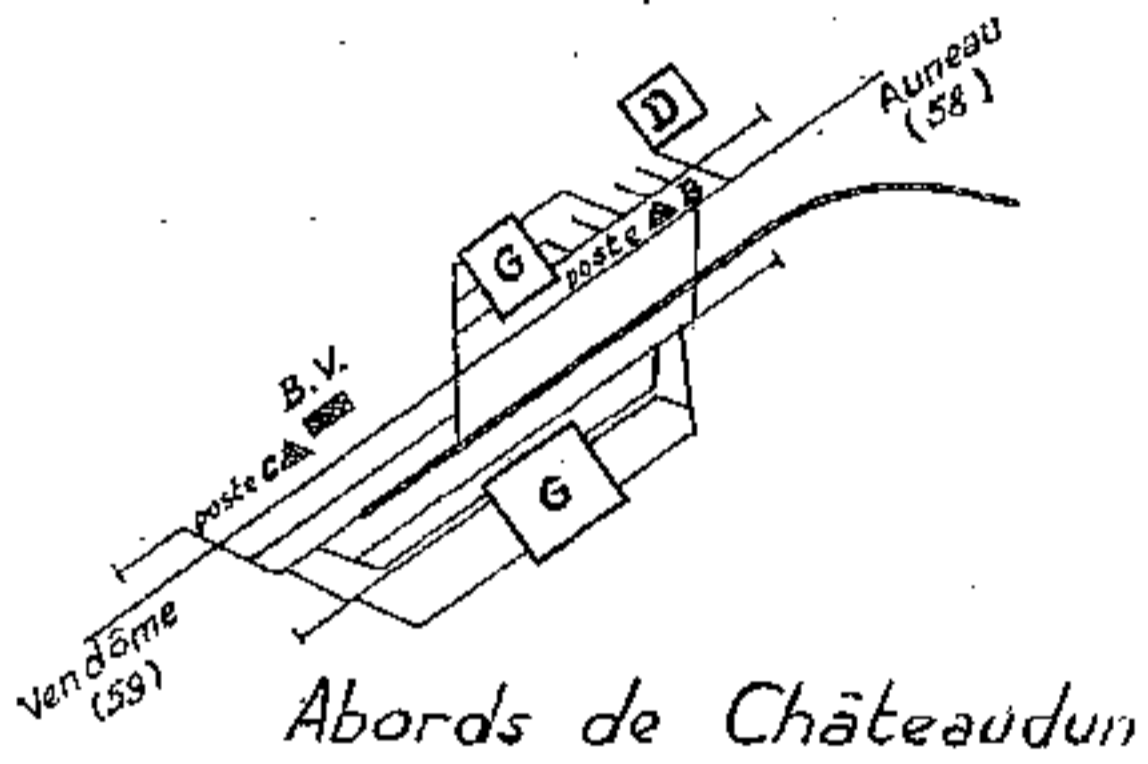
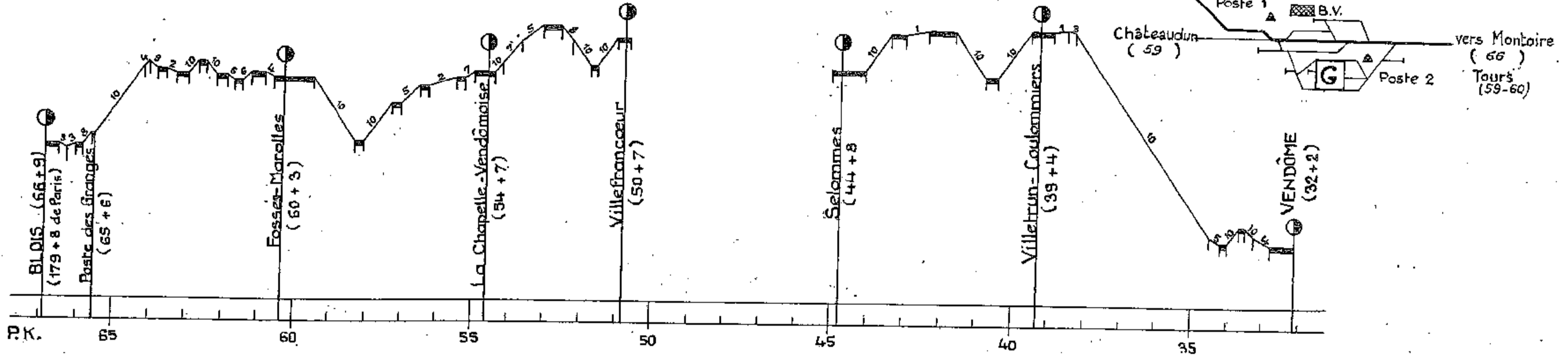

Ligne de Châteaudun à Patay

Abords de Châteaudun

Abords de Patay

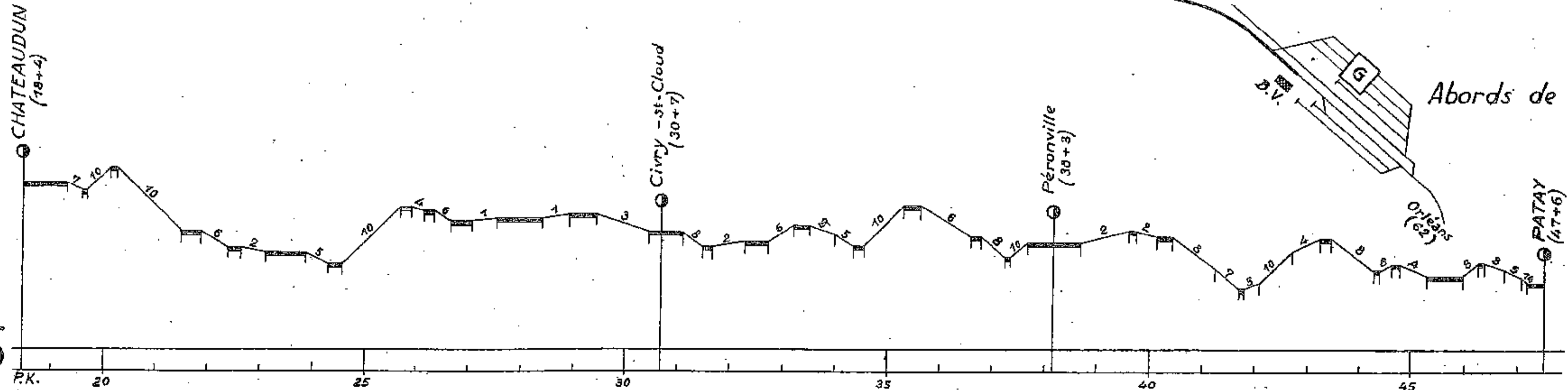

Ligne de Pleumartin à Tournon St Martin

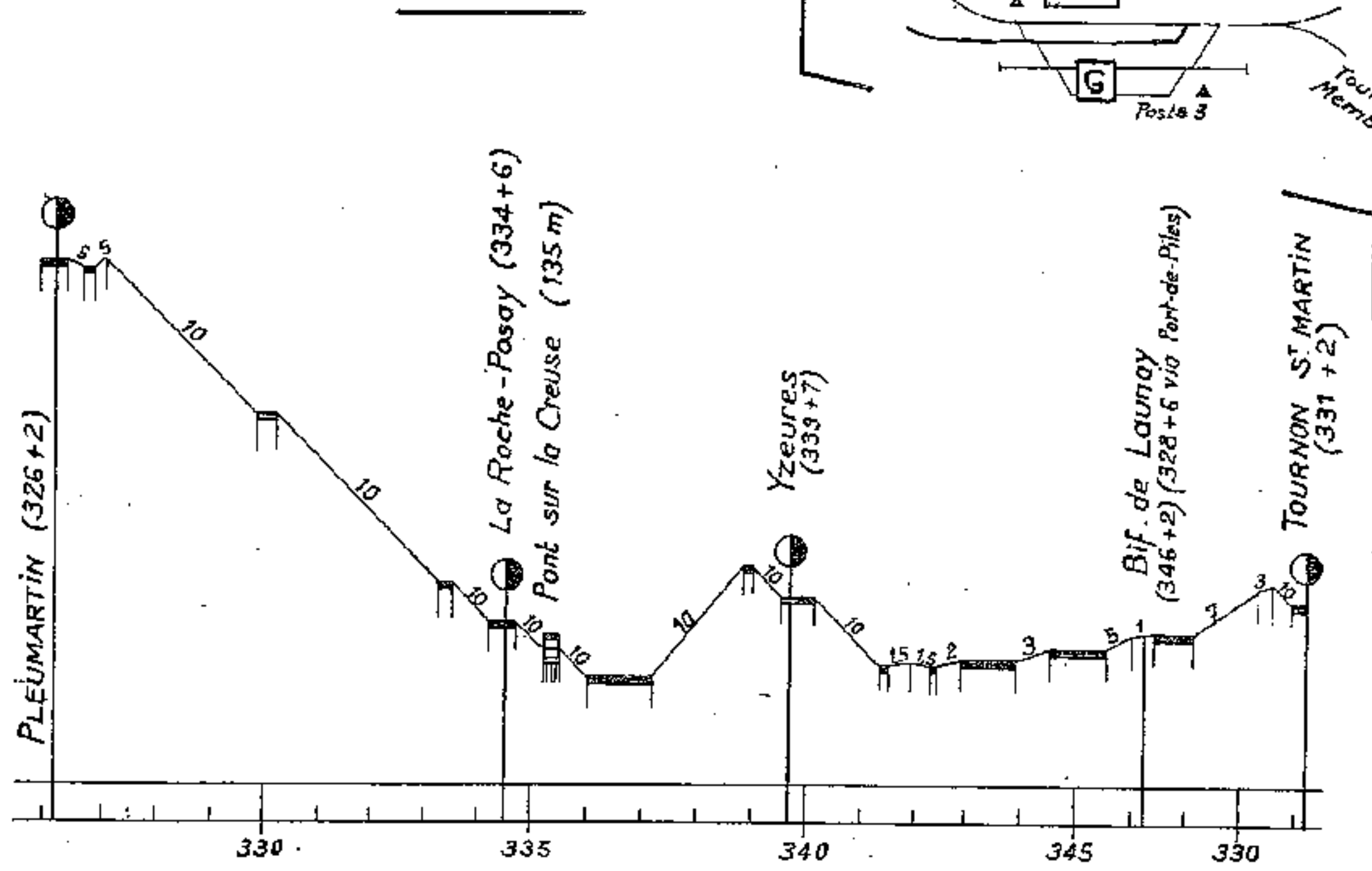

Ligne de Authon-Monthodon à Tours

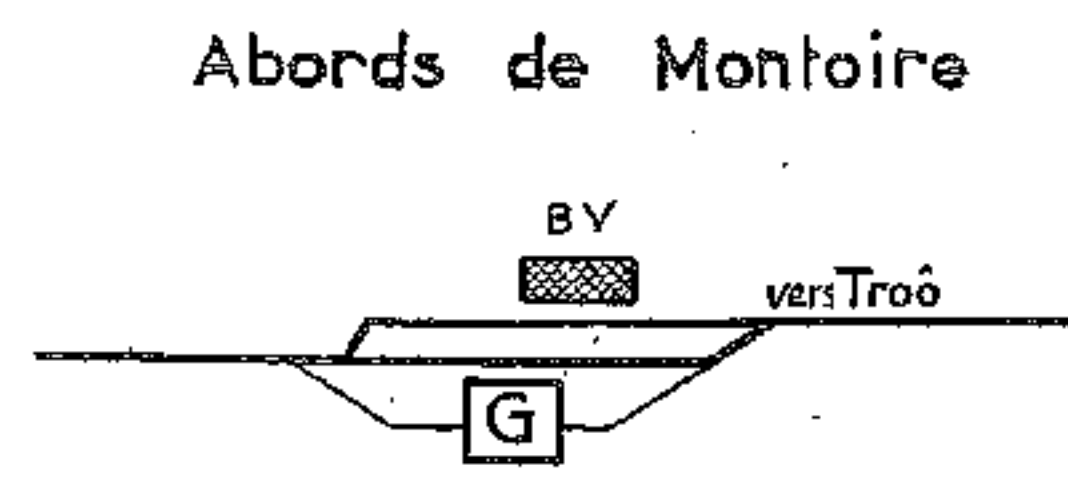
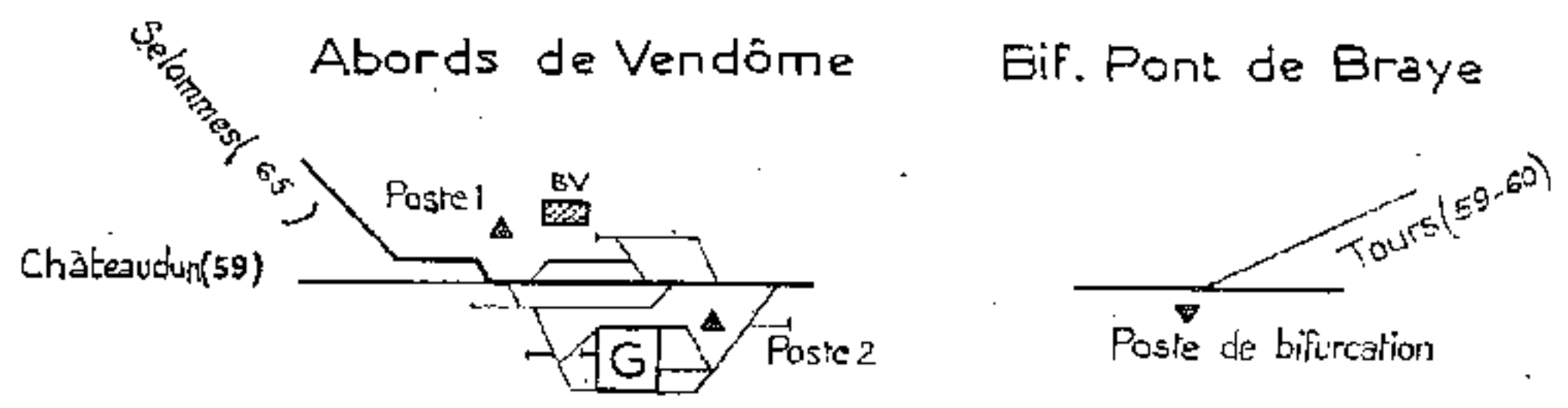
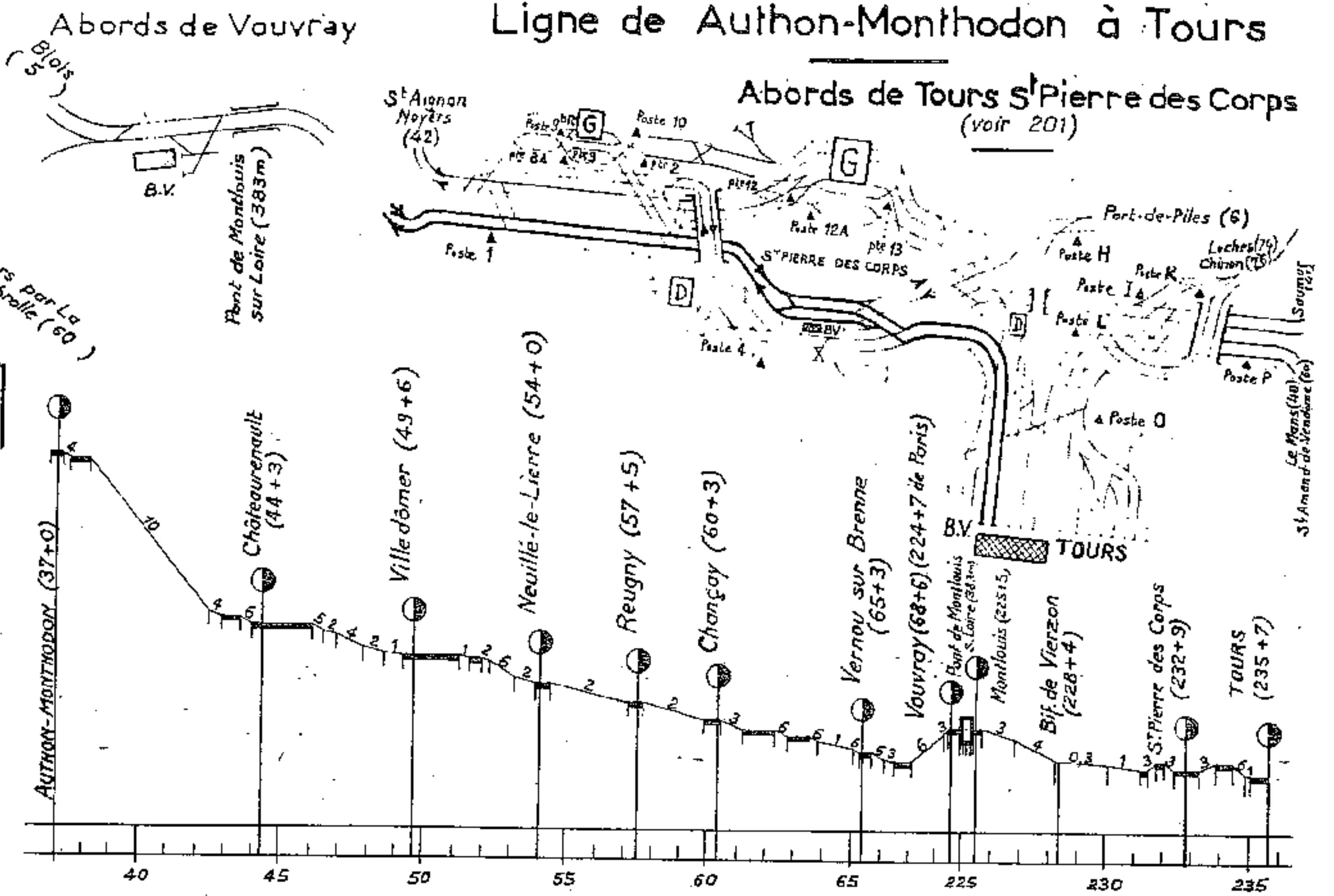

Ligne de Blois à Troô Section de Vendôme à Troô

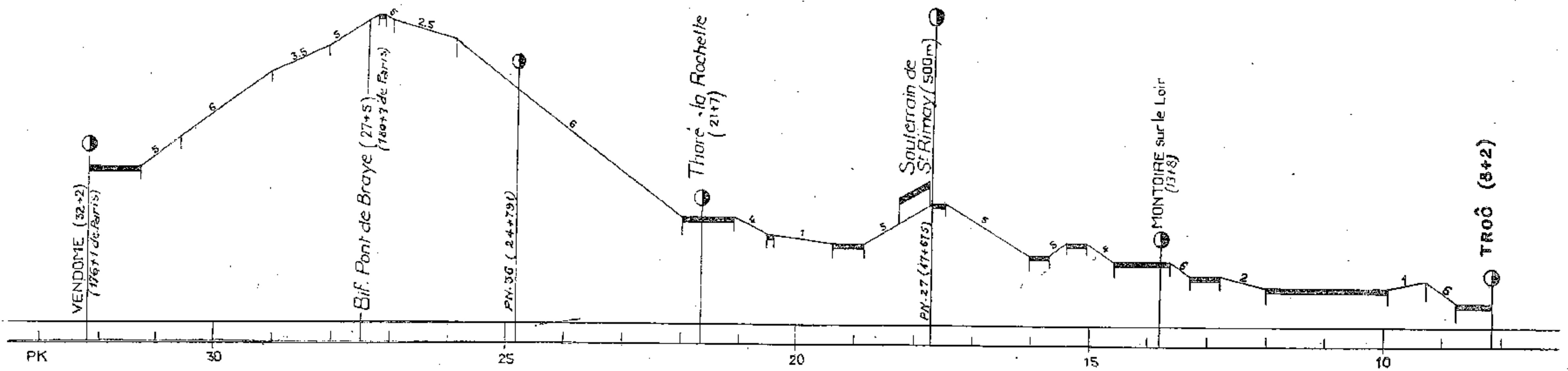

① Abords de
 ② Bellegarde-Quiers

Abords des Bordes

Ligne d'Etampes à Bourges
 Section de Bellegarde-Quiers à Argent

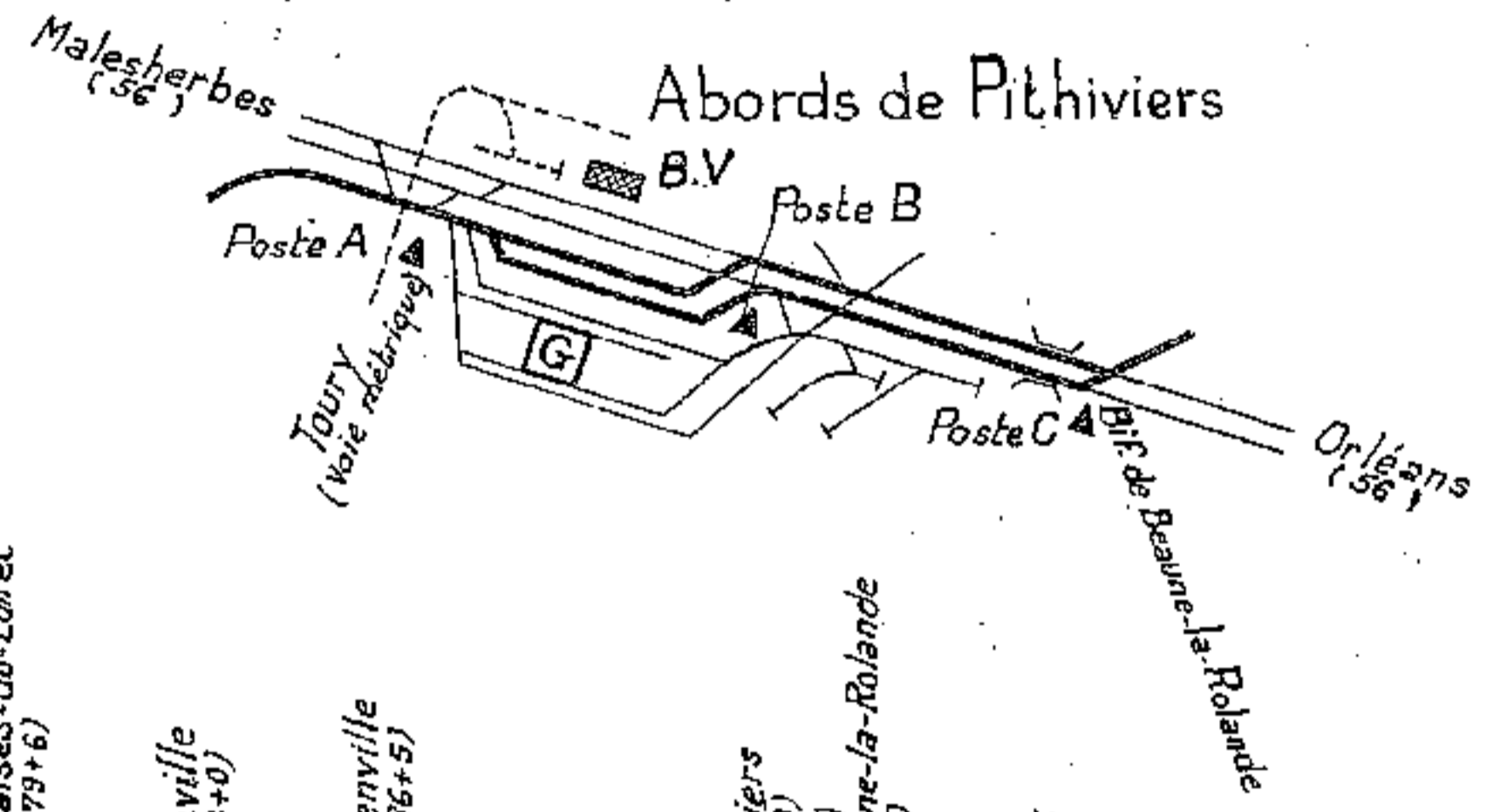
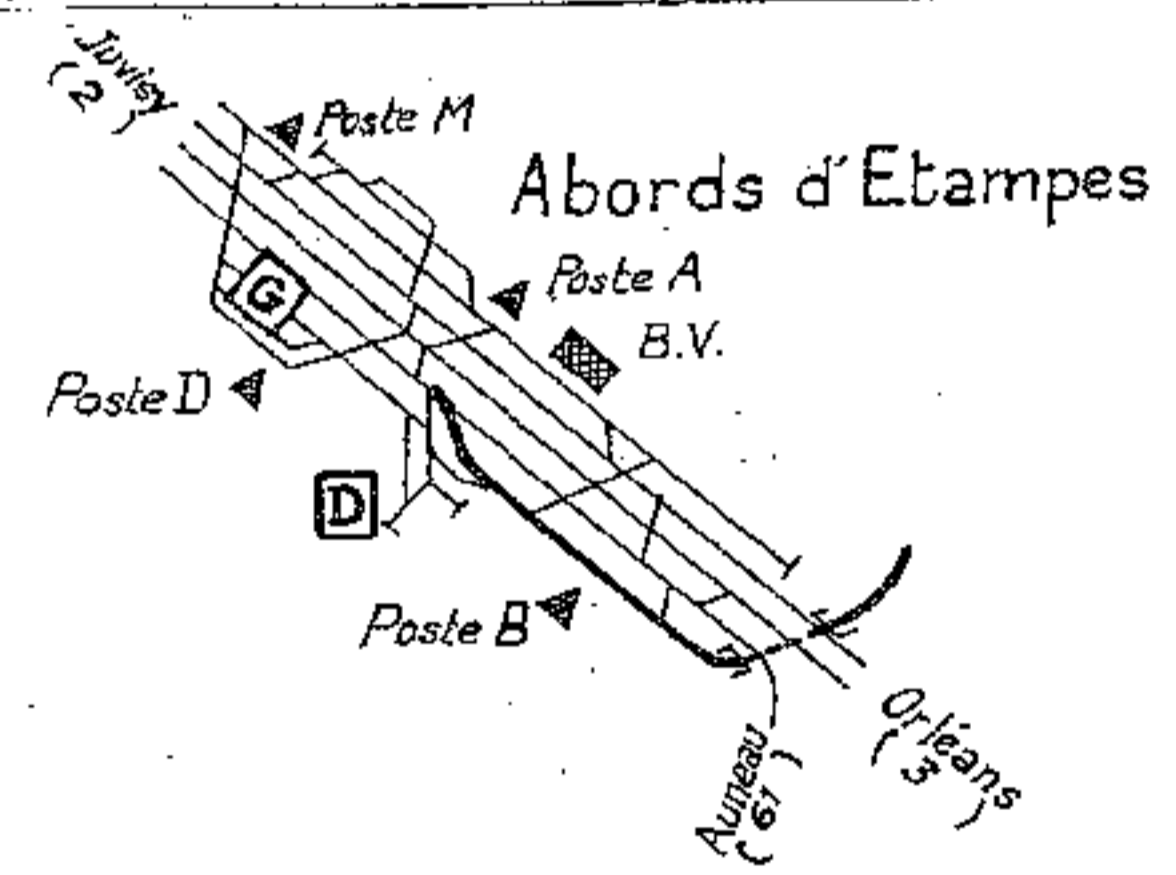
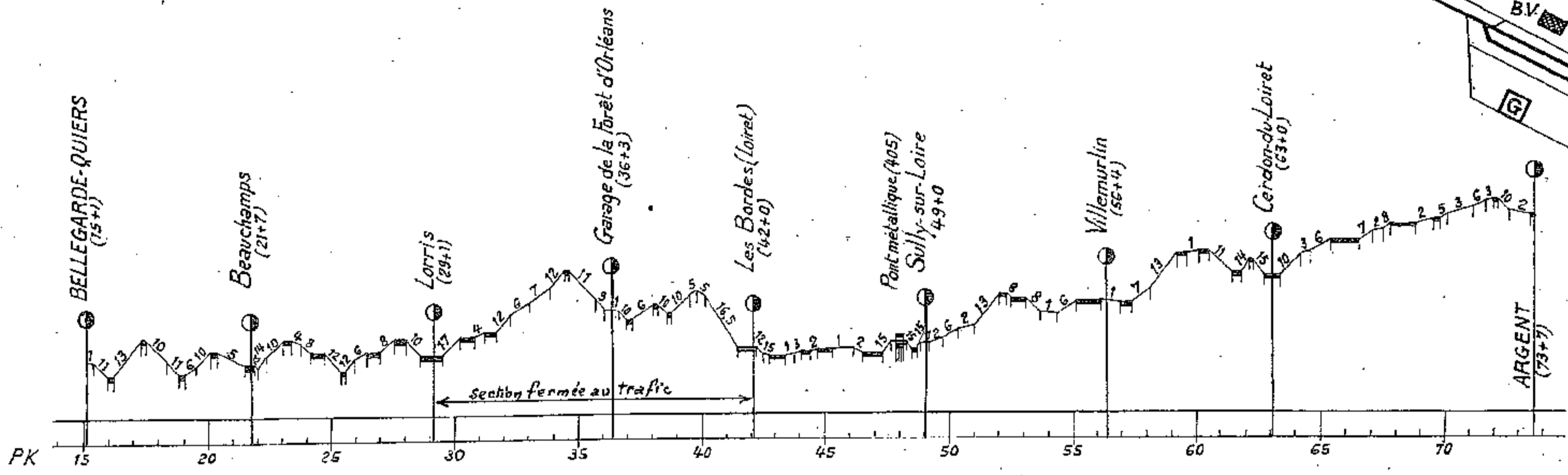
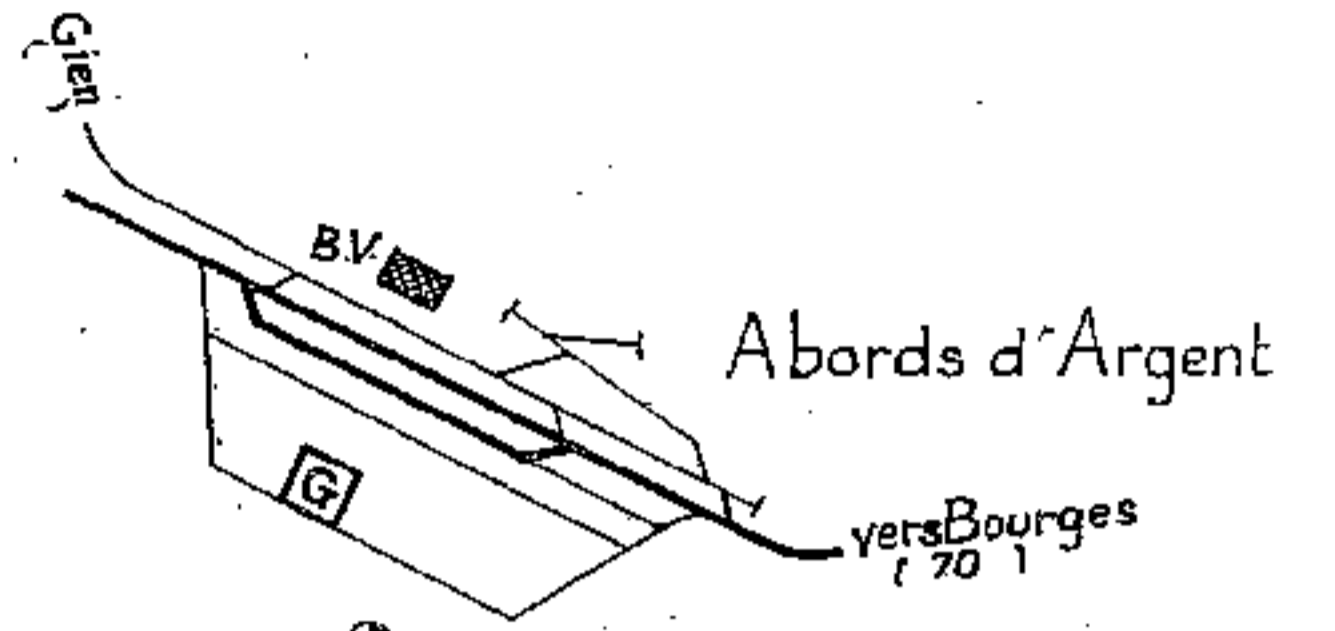
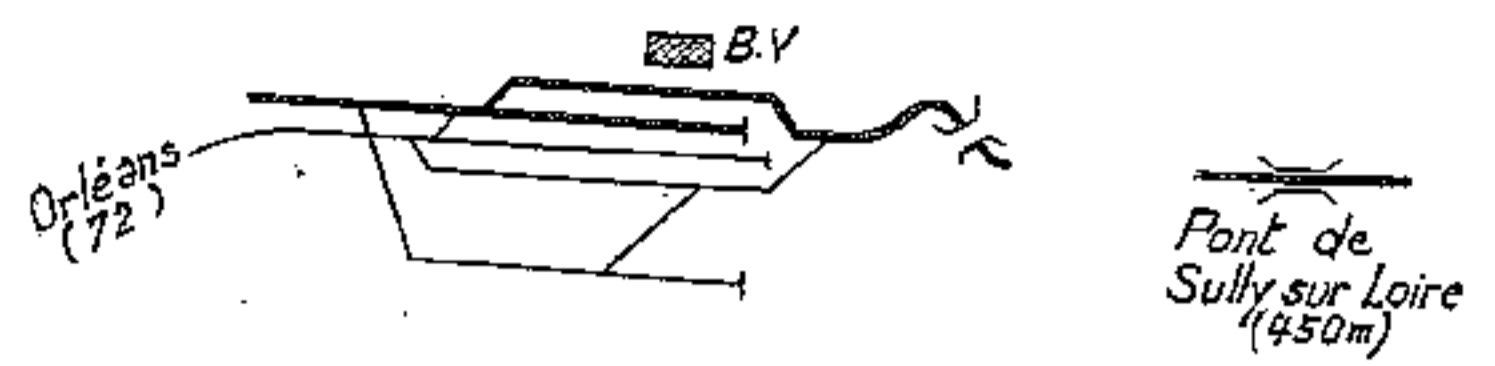
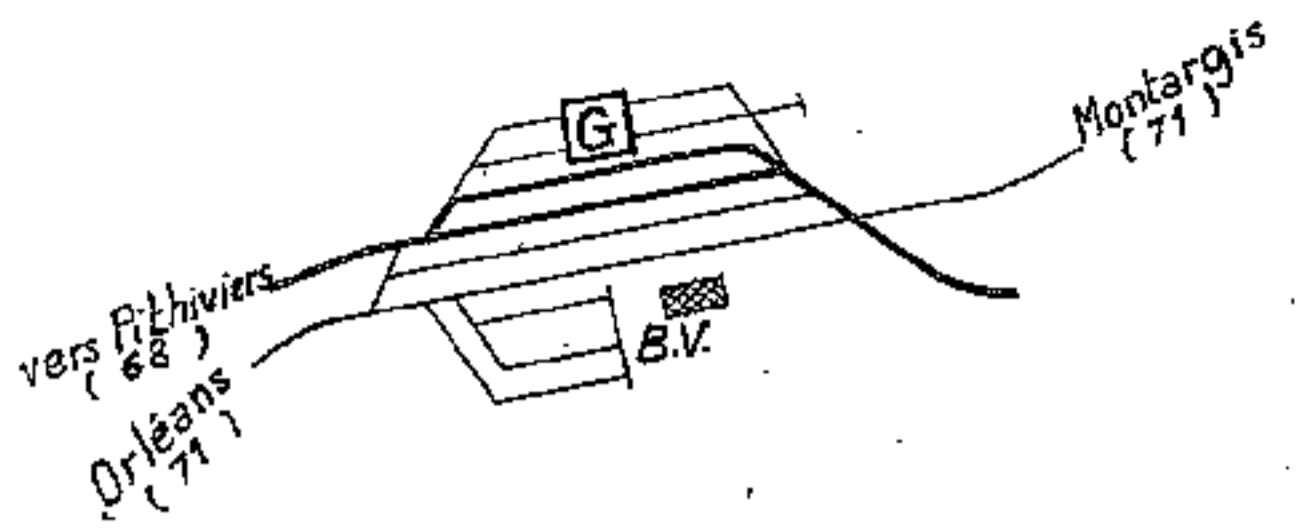

Ligne d'Etampes à Bourges
 Section d'Etampes à Bellegarde-Quiers

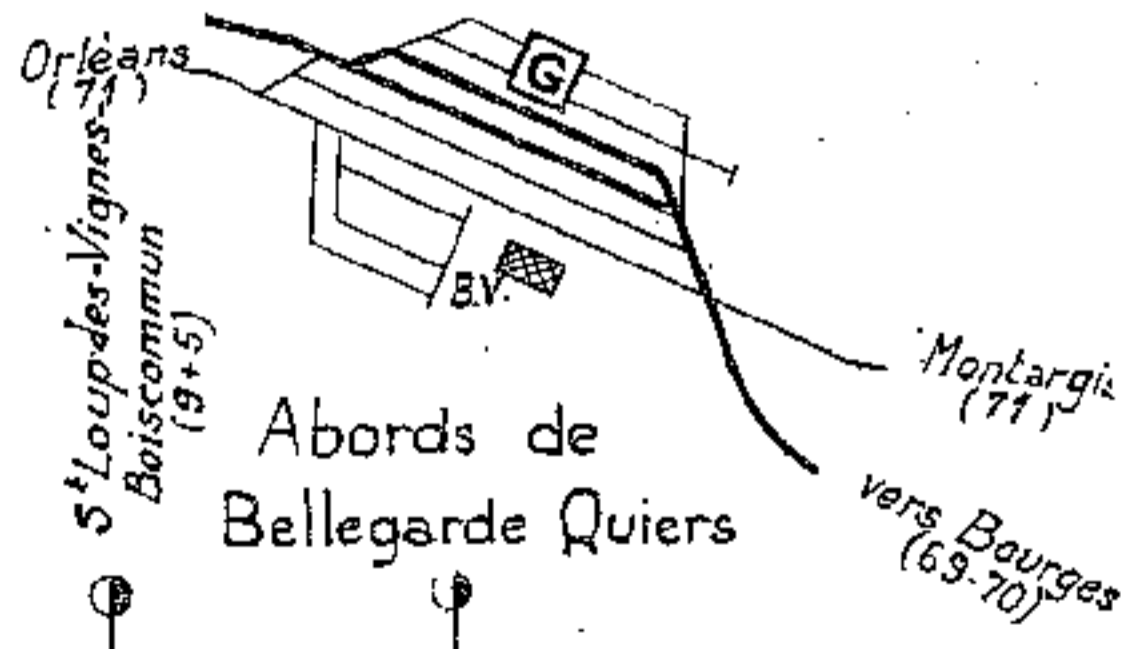
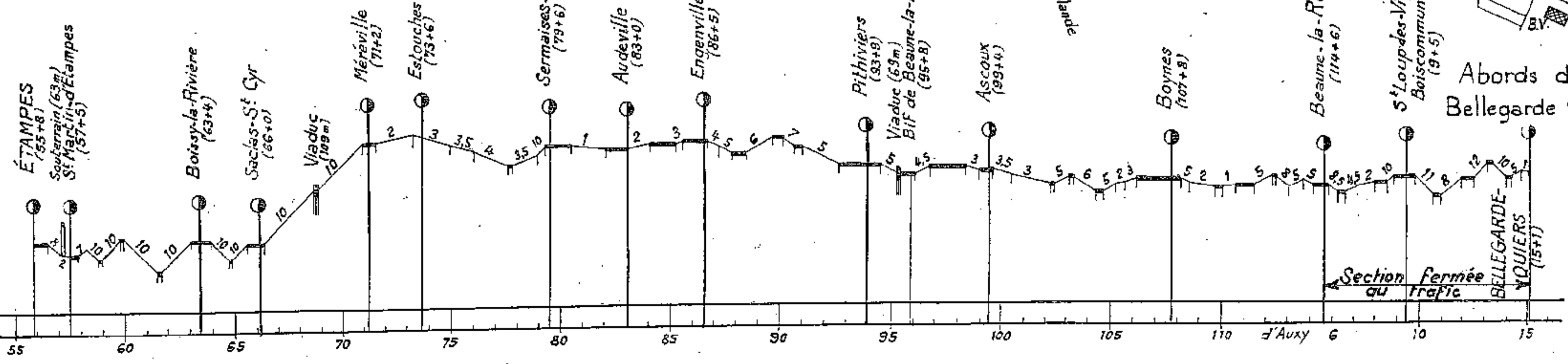

Ligne de Montargis à Orléans

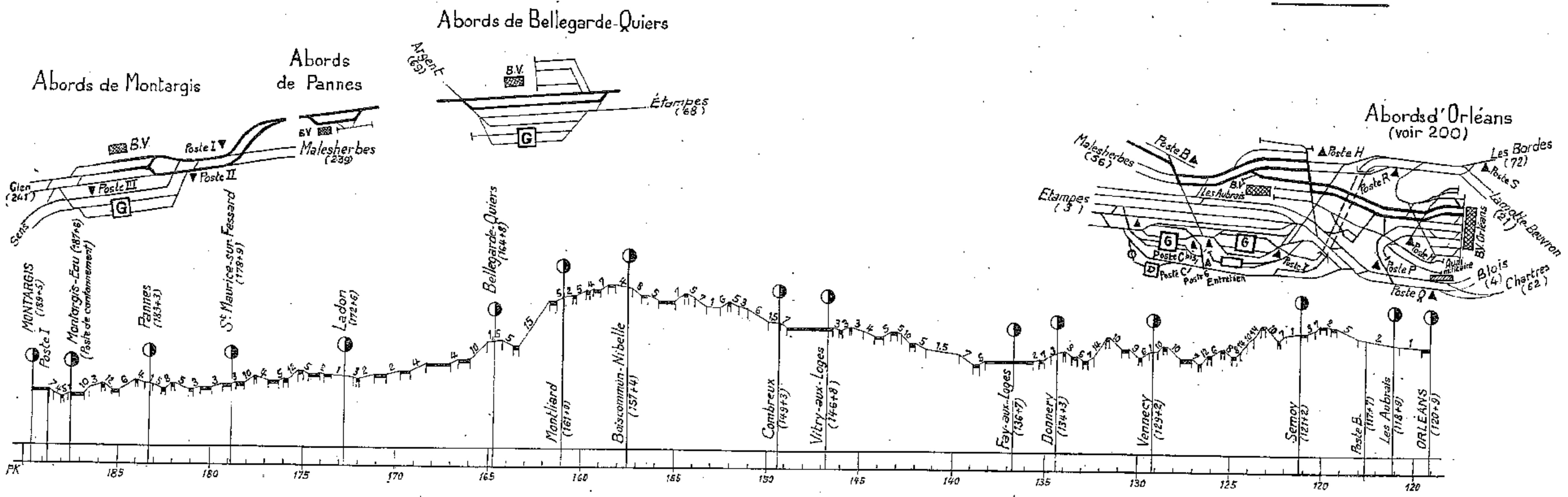

Ligne d'Etampes à Bourges

Section d'Argent à Bourges



Abords de Bourges

Ligne de Bourges à Cosne

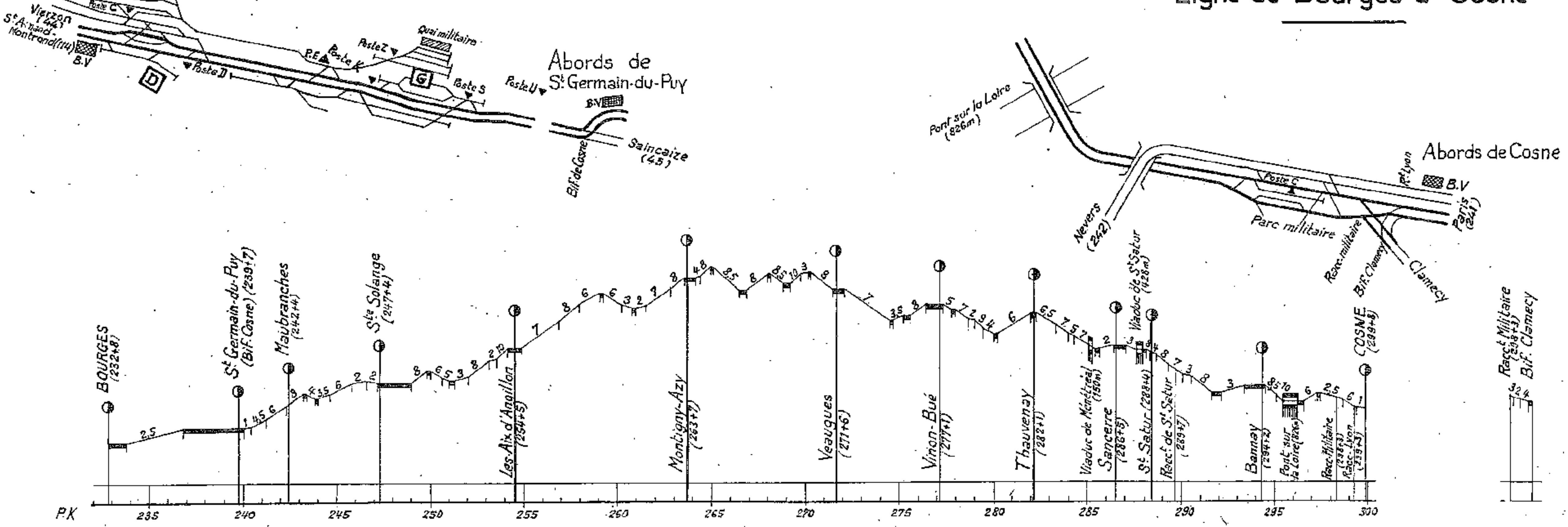

Abords des Aubrais-Orléans (voir 200)

Ligne d'Orléans aux Bordes

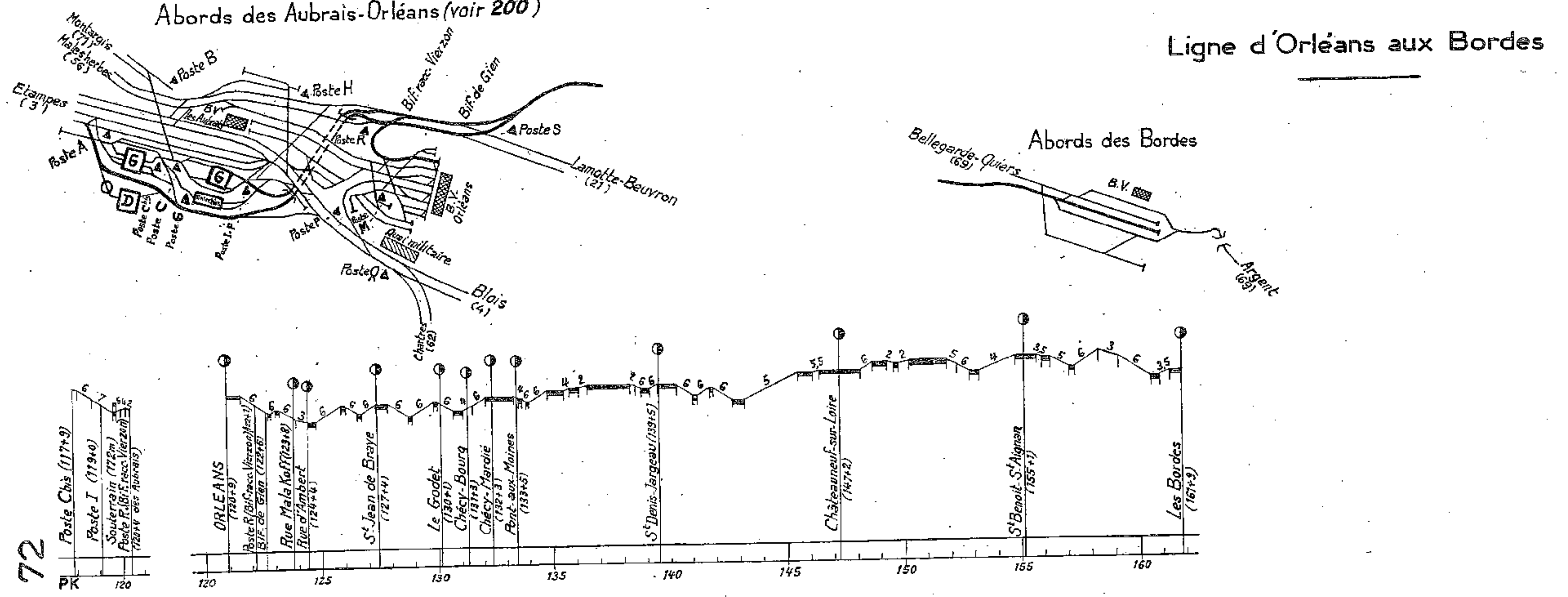

Ligne de Tours à Châteauroux

Section de Loches à Châteauroux

Abords de Loches

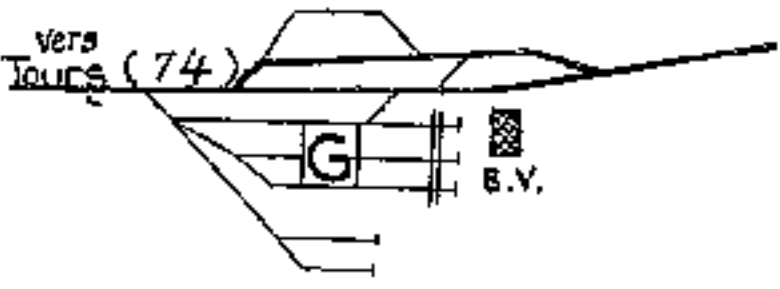

Abords de Châteauroux

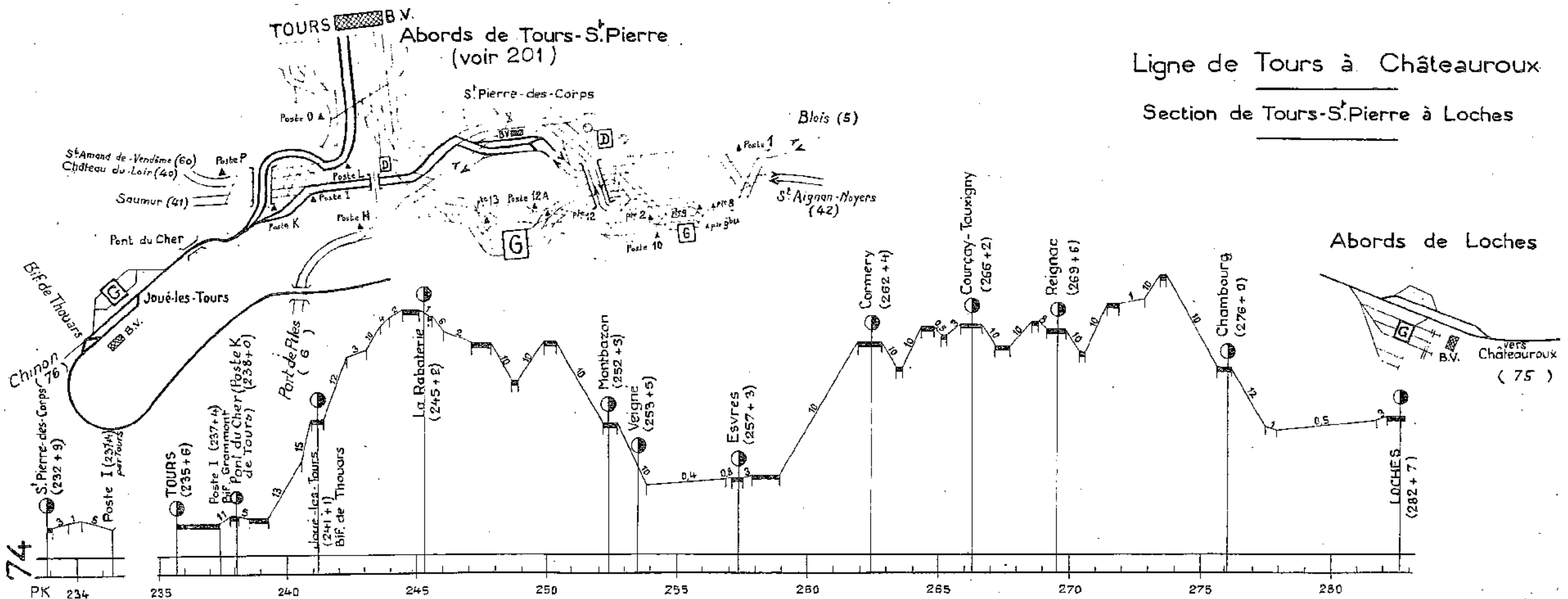
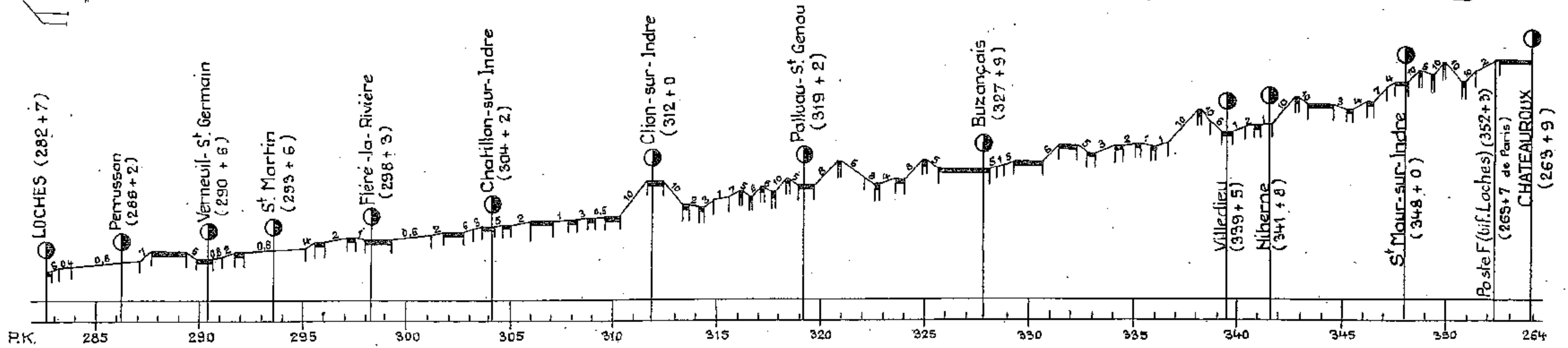
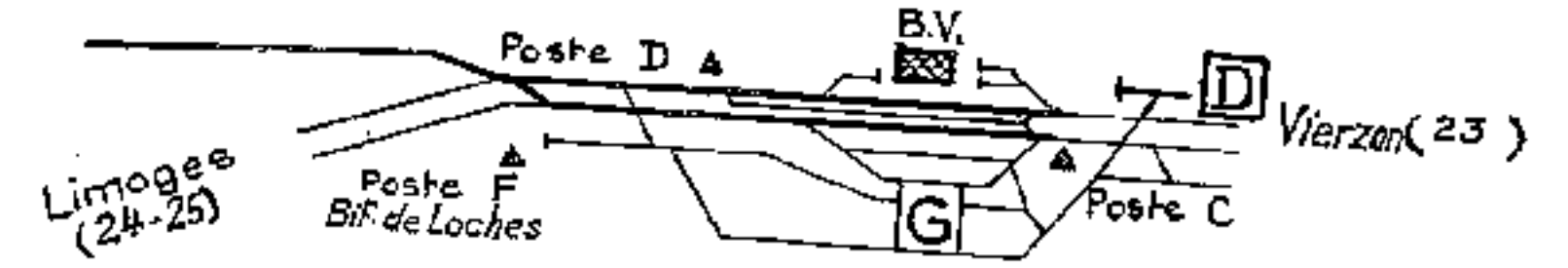

Ligne de Tours à Châteauroux

Section de Tours-S. Pierre à Loches

Abords de Loches

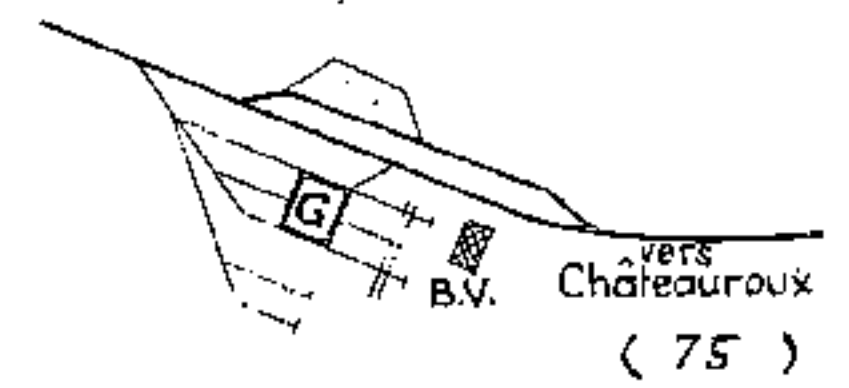

Abords de Tours-S. Pierre (voir 201)

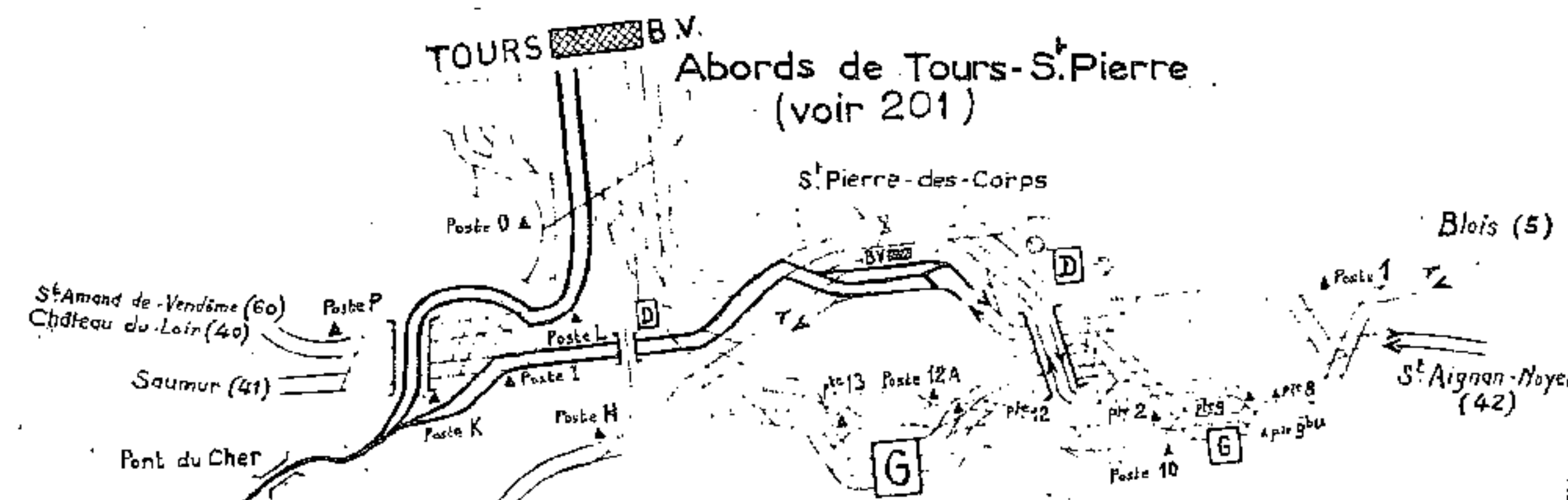

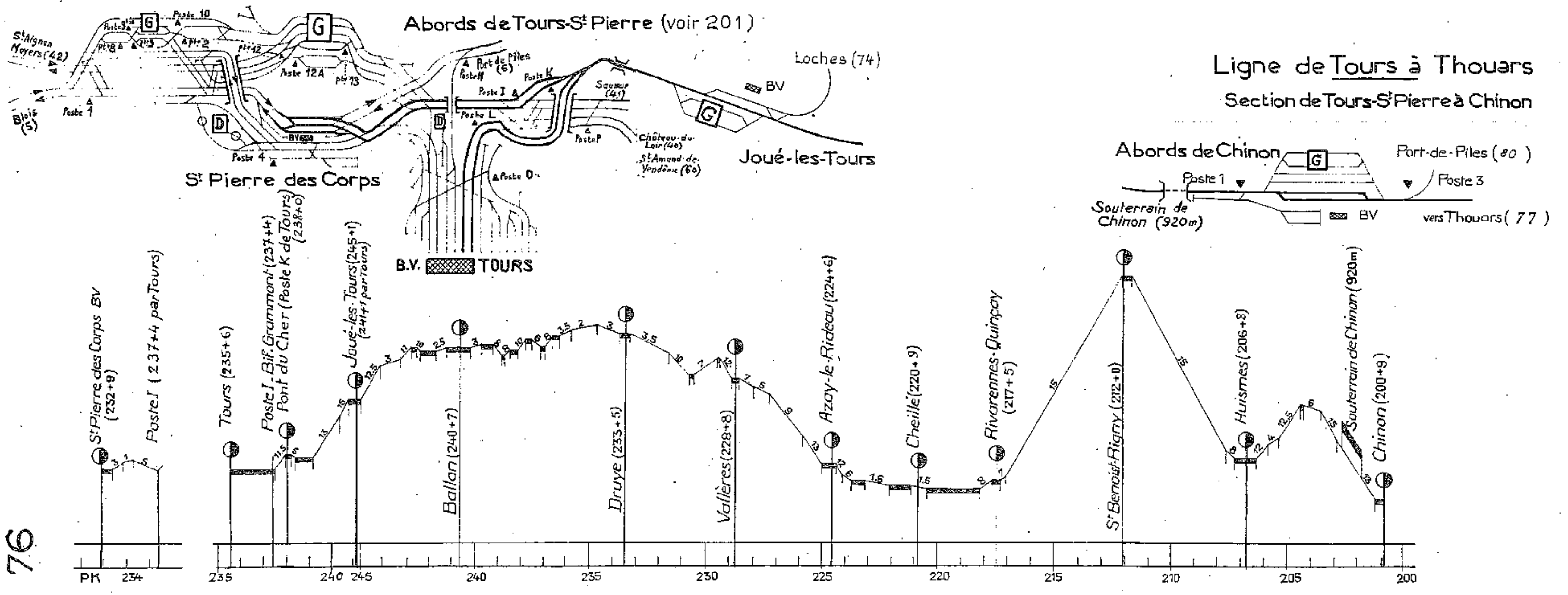
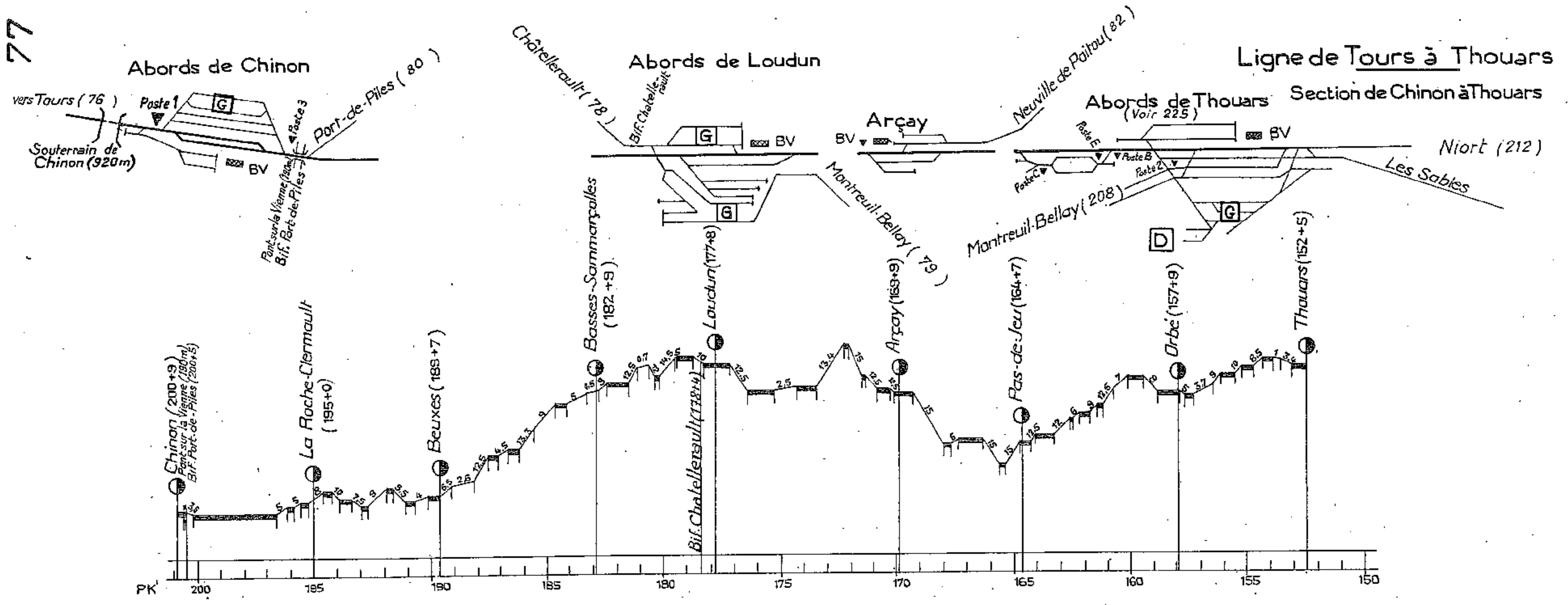

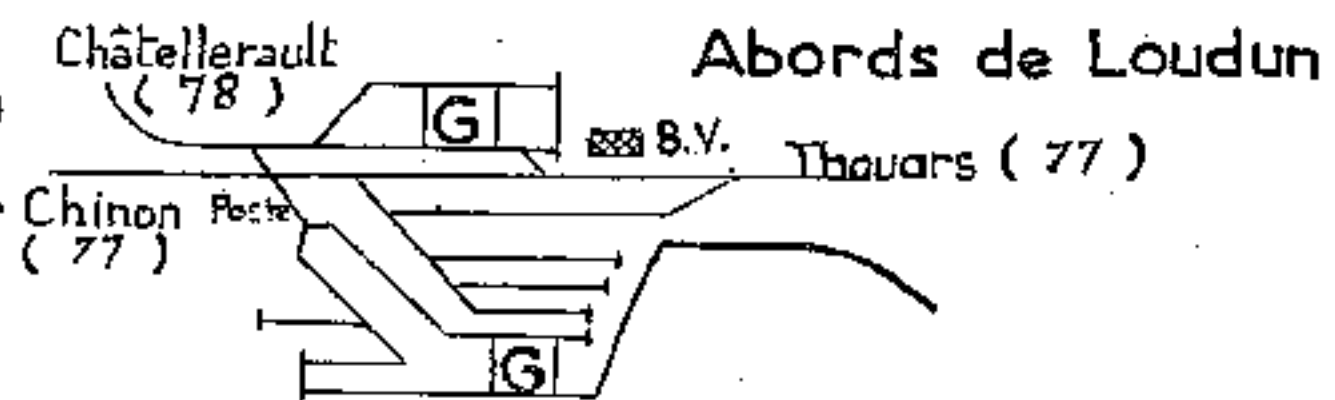

Ligne de Loudun à Montreuil-Bellay

Abords de Montreuil-Bellay

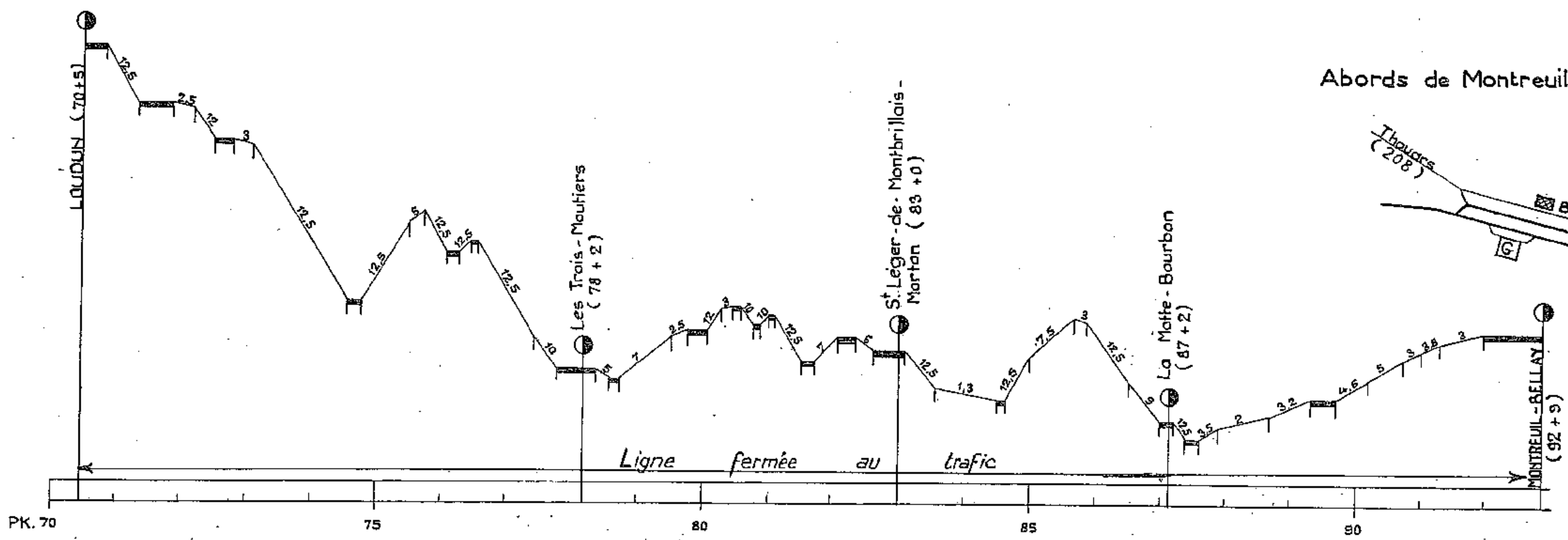
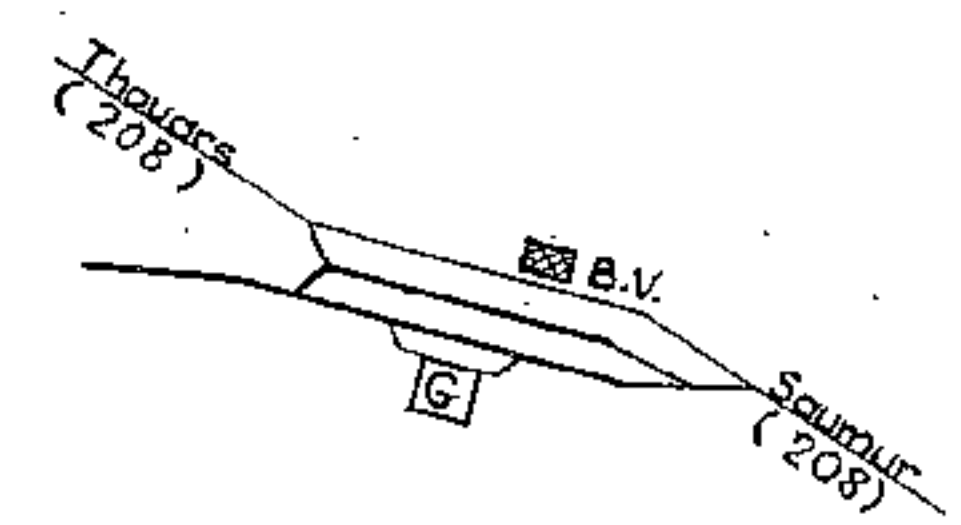

Abords de Loudun

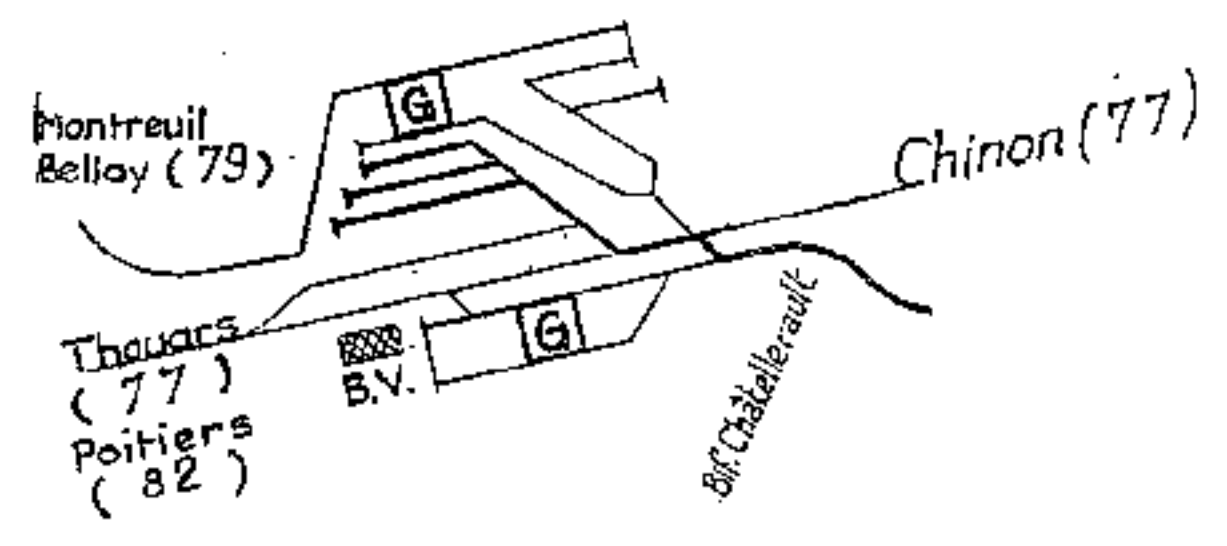

Ligne de Loudun à Châtellerault

Abords de Châtellerault

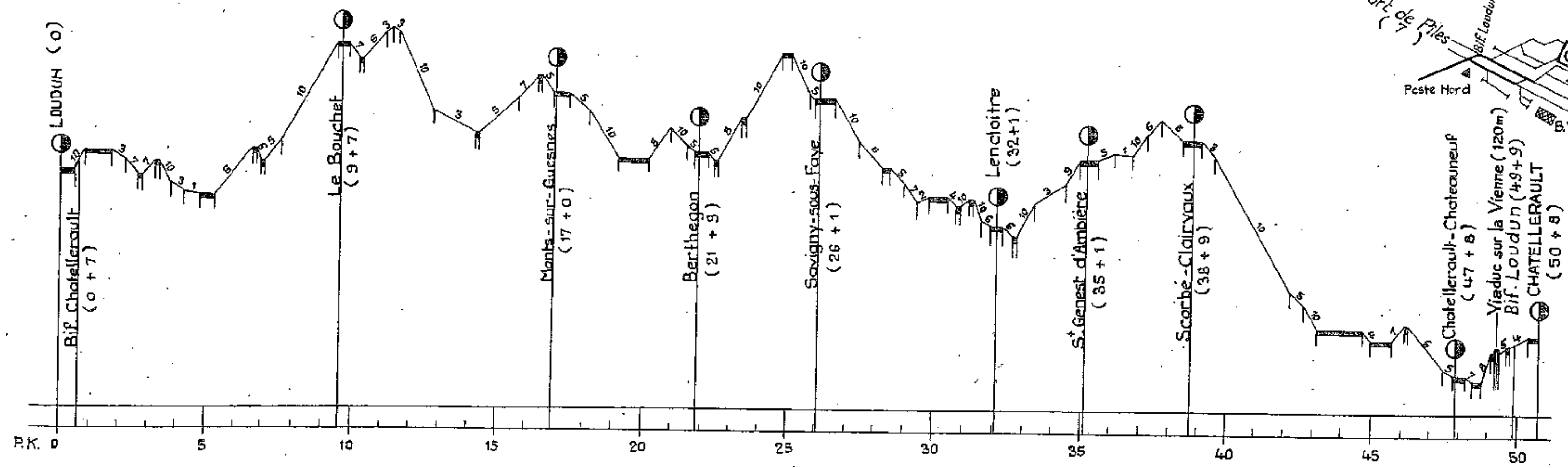
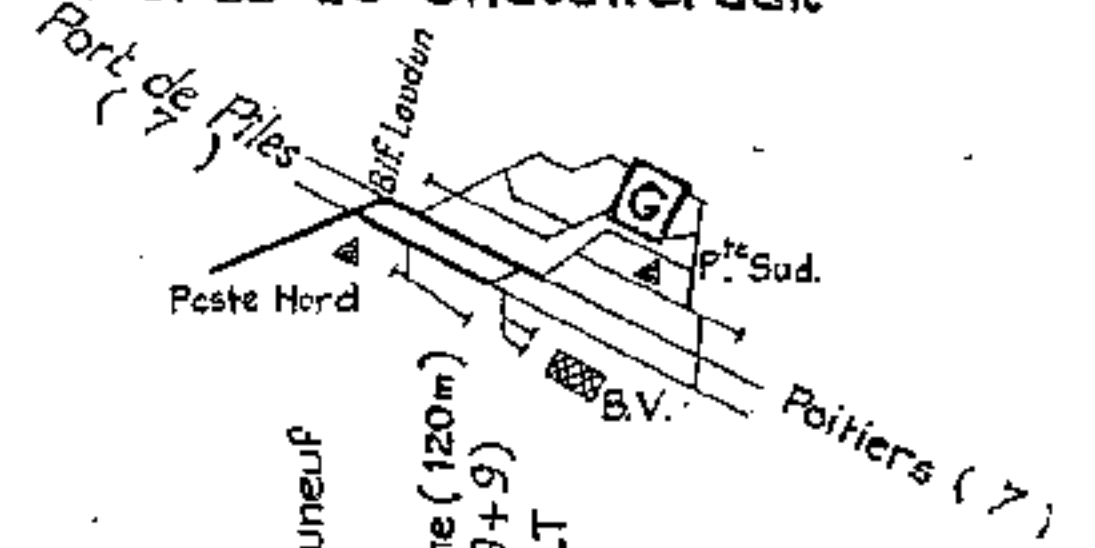

Ligne de Ligré - Rivière à Richelieu

80

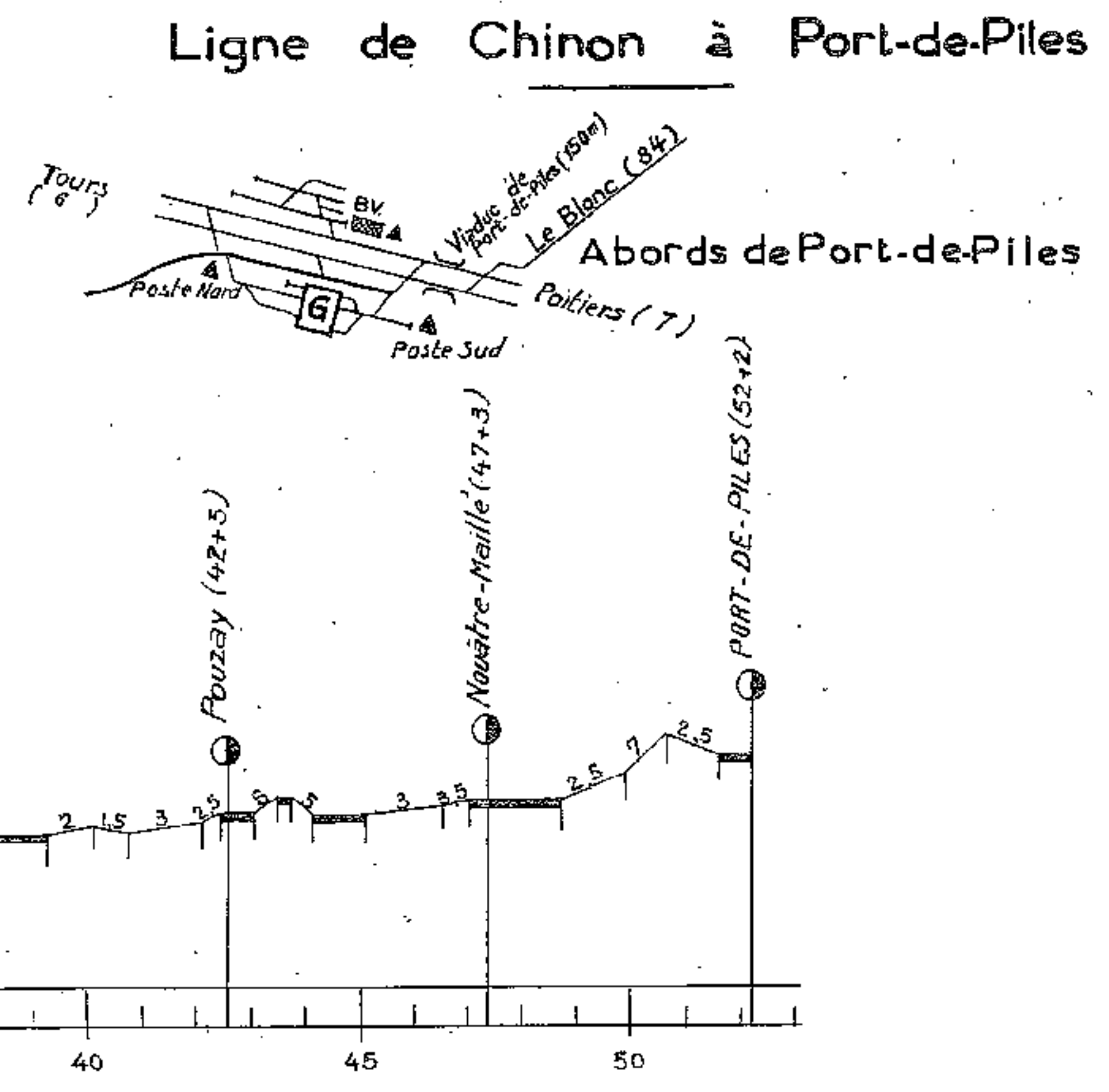
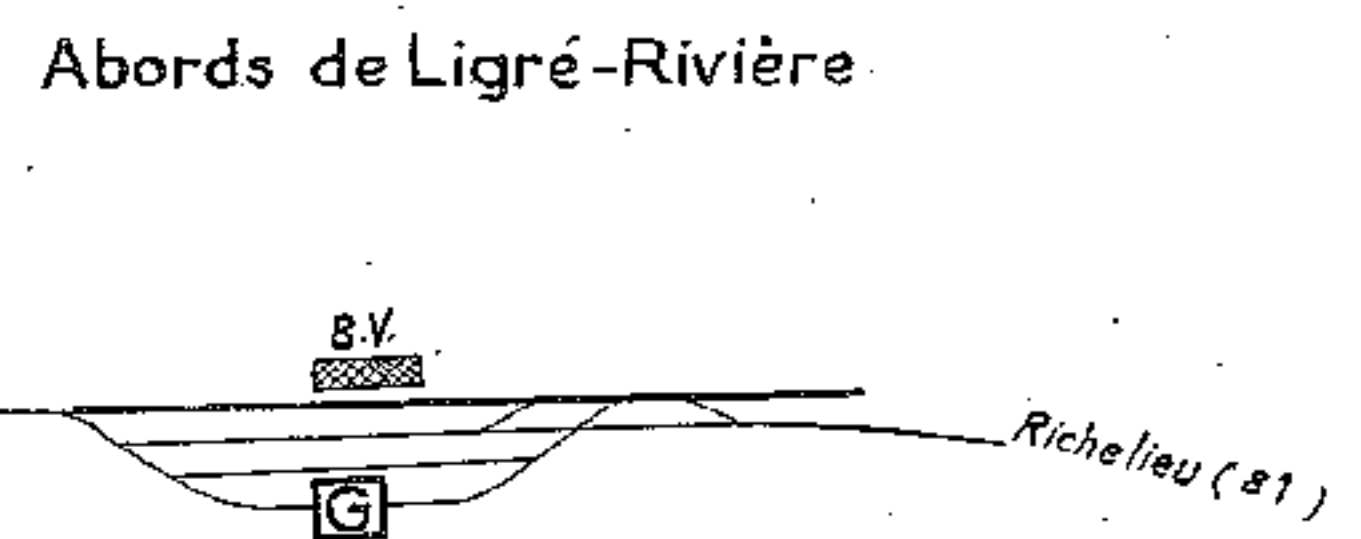
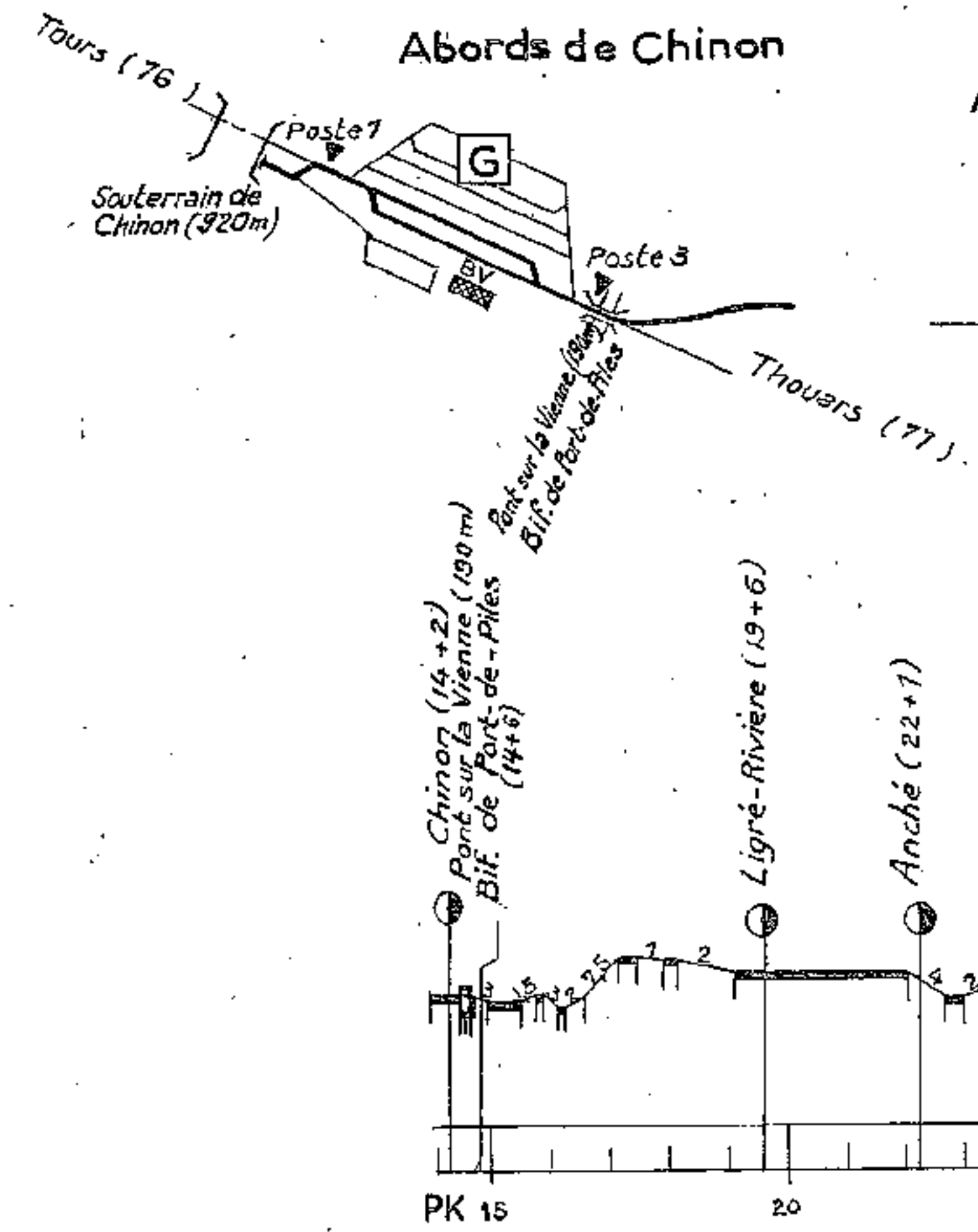
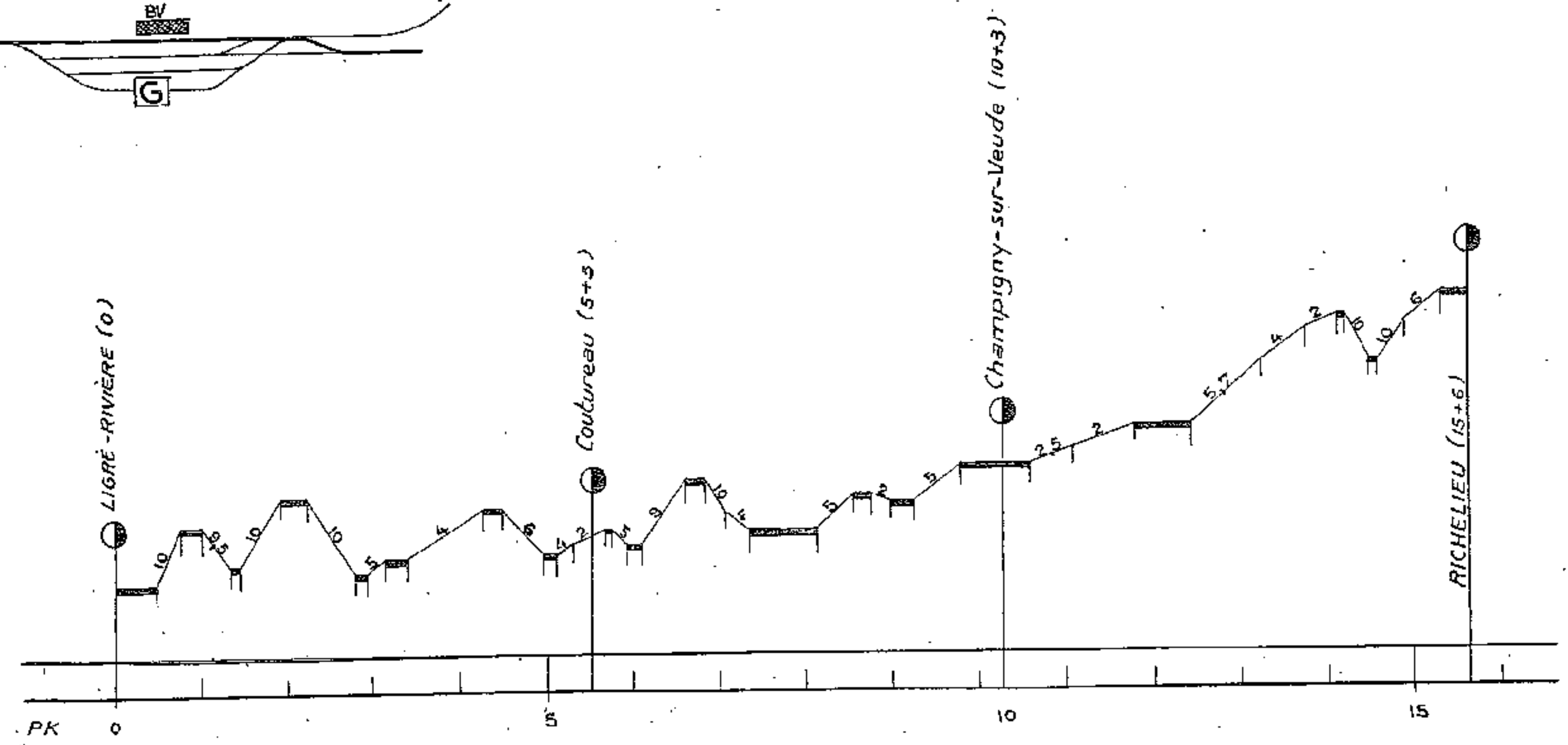

80

Parthenay

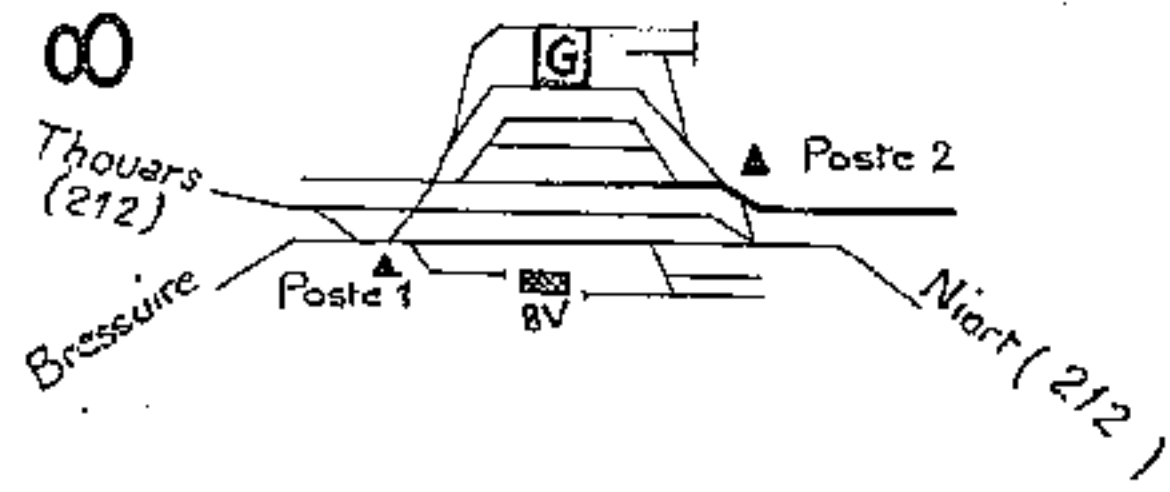

Ligne de Parthenay à Poitiers

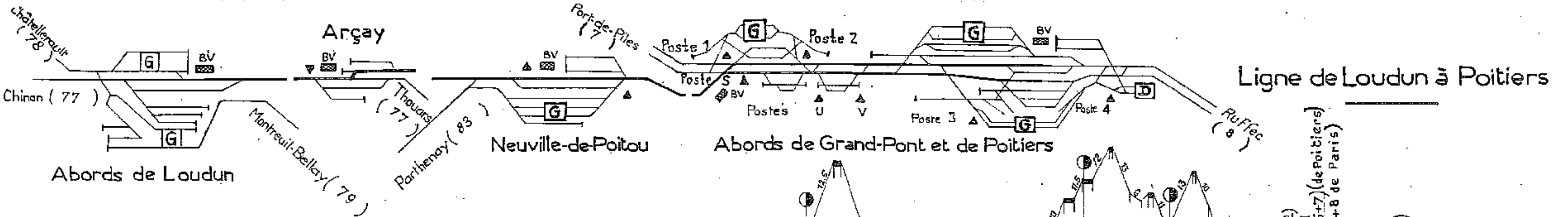
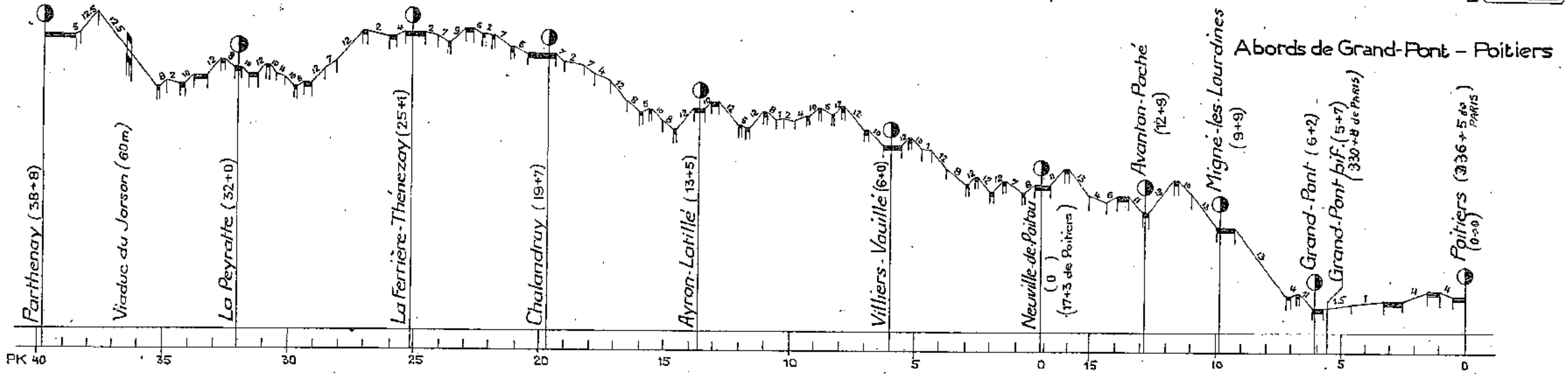
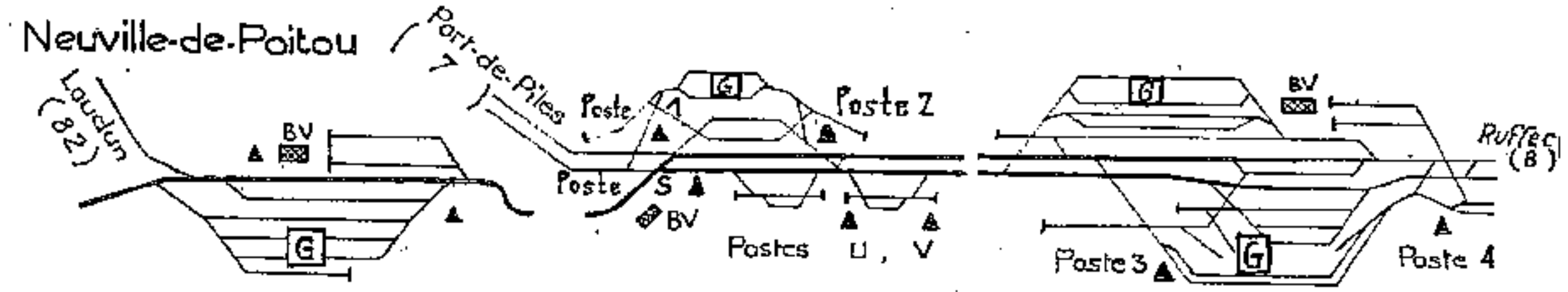

Ligne de Loudun à Poitiers

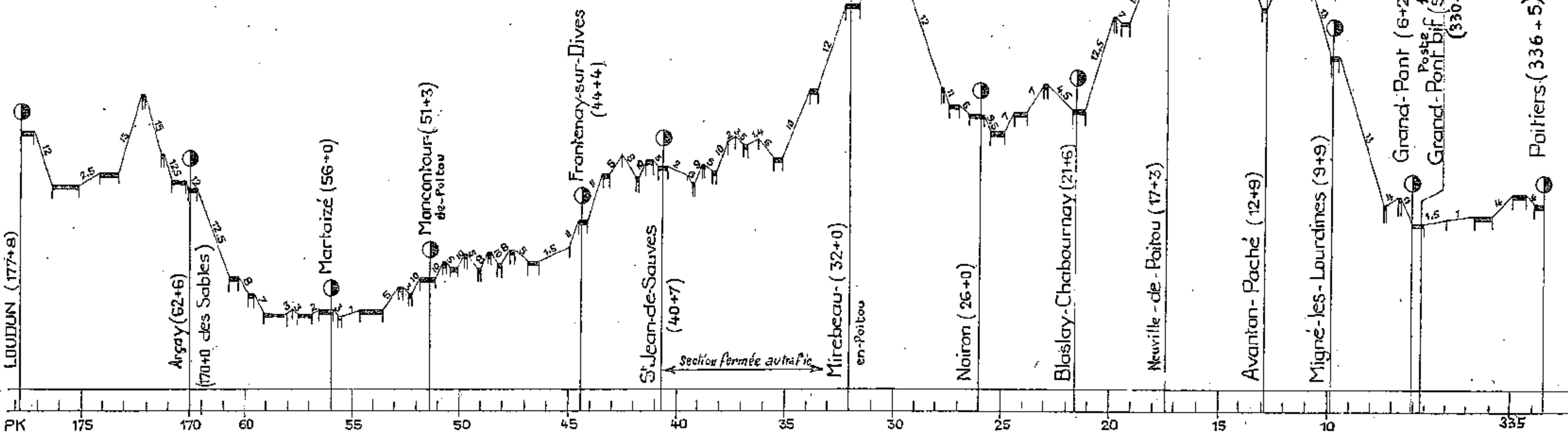

Abords de Poitiers

MIGNALOUX-NOUAILLÉ

Ligne de Poitiers à Argenton

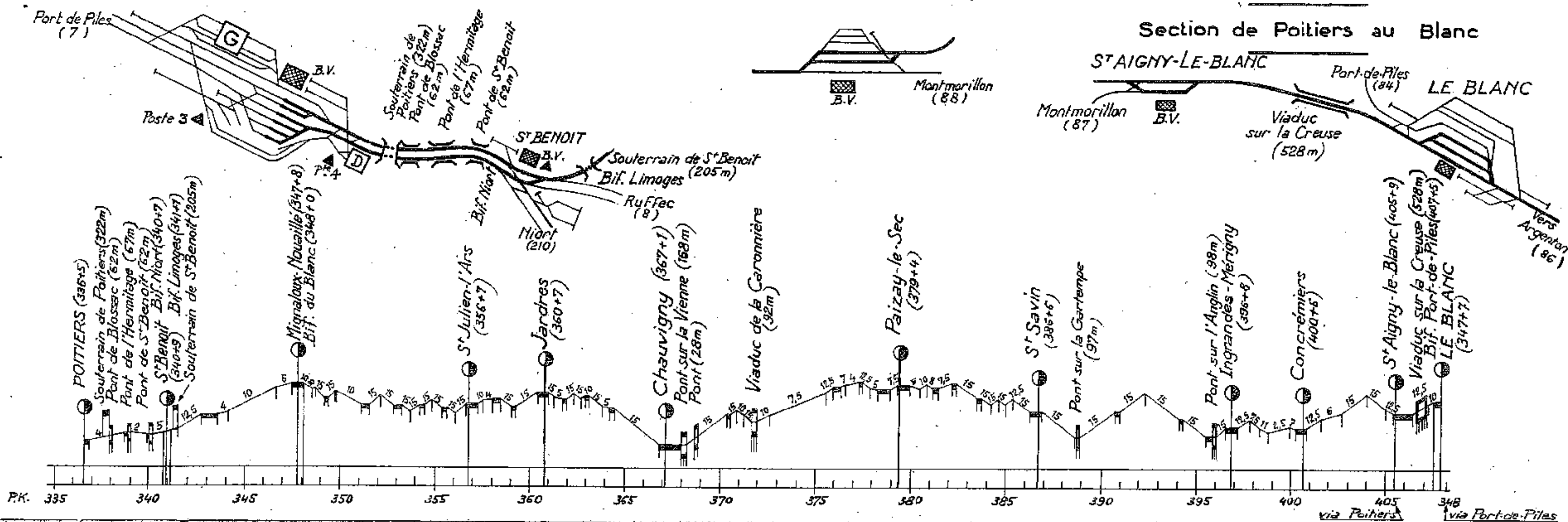

Abords de Port-de-Piles

Ligne de Port-de-Piles au Blanc

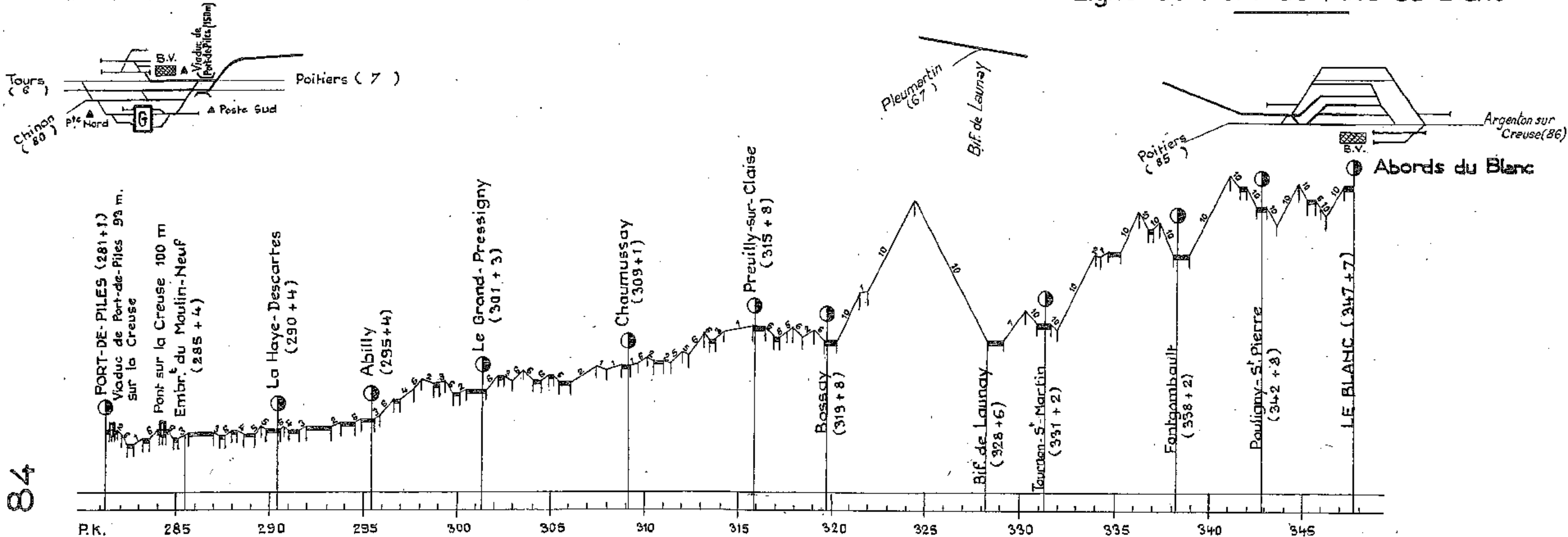

Poitiers (88)

MONTMORILLON

Ligne de Montmorillon au Blanc

Poitiers (85) ST AIGNY-LE-BLANC

Port-de-Piles (84)

LE BLANC

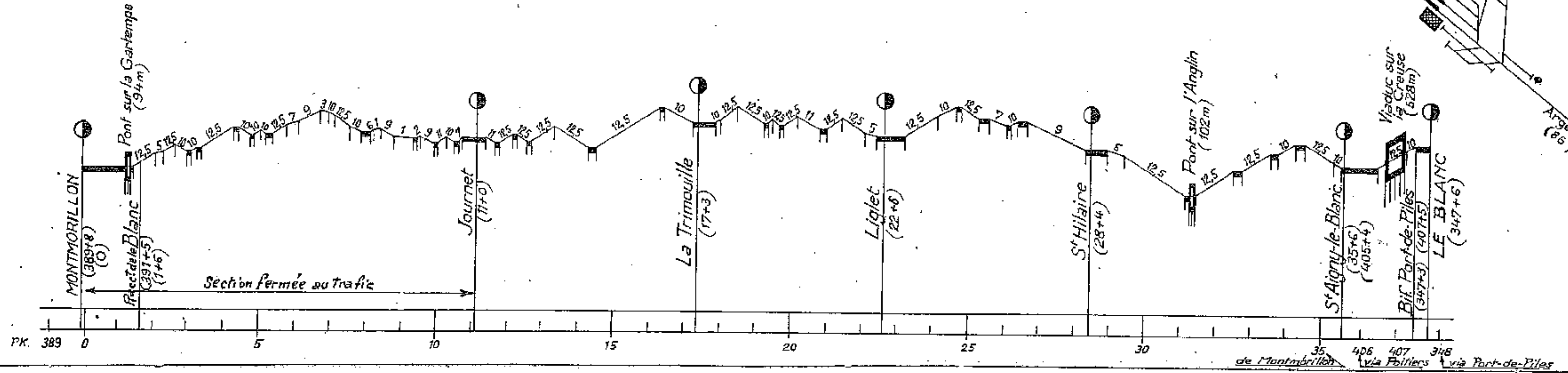
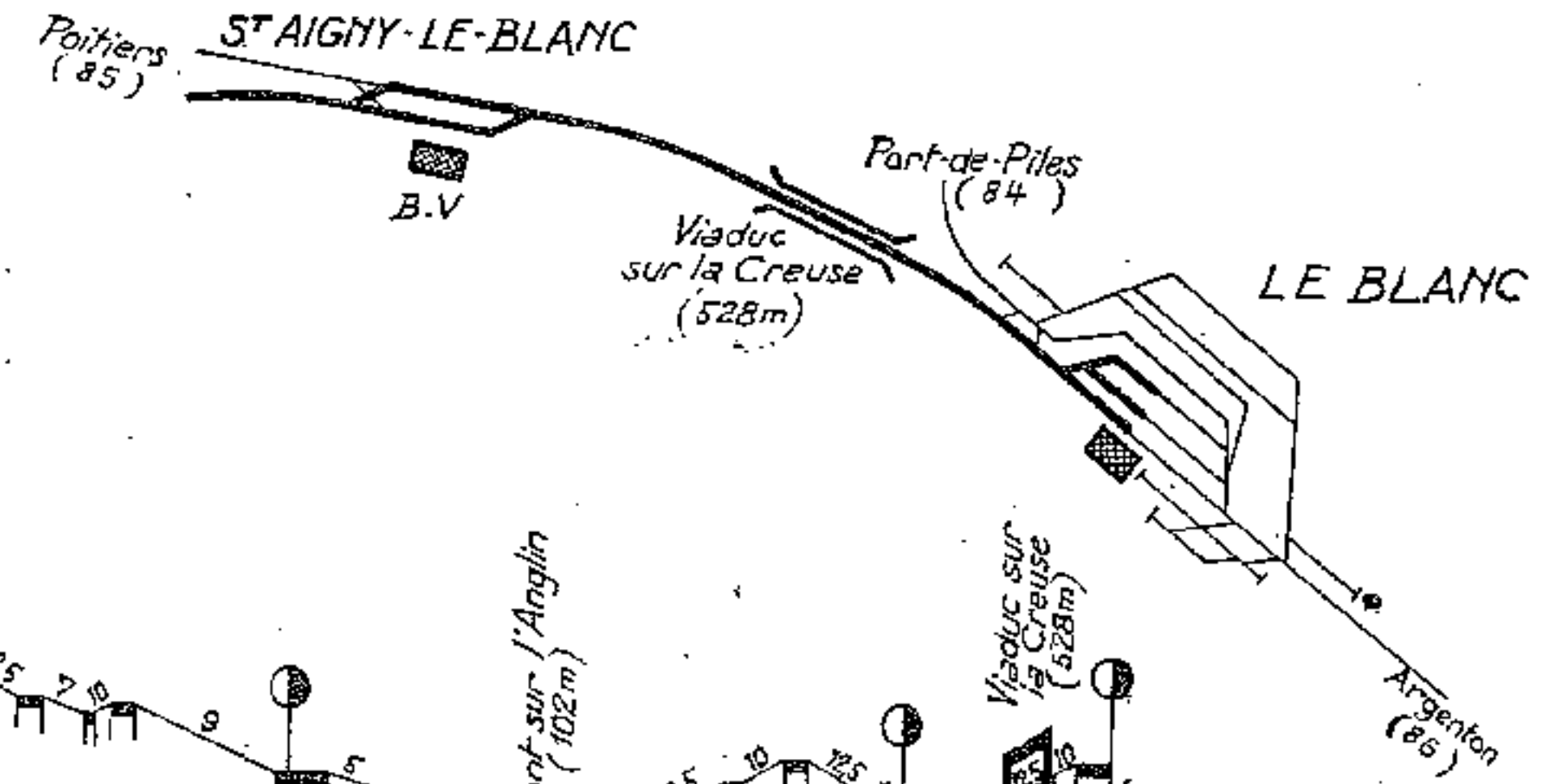

LE BLANC

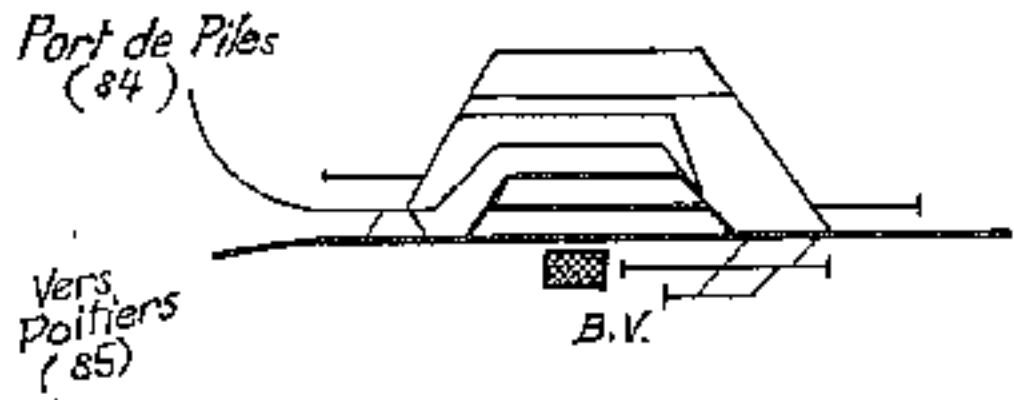

Ligne de Poitiers à Argenton

Section du Blanc à Argenton

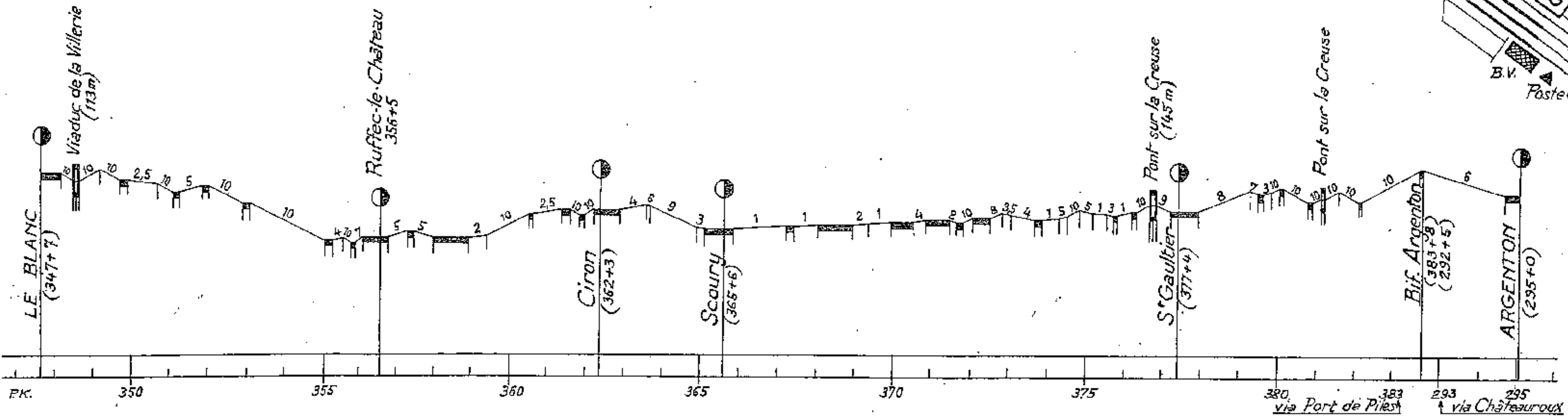
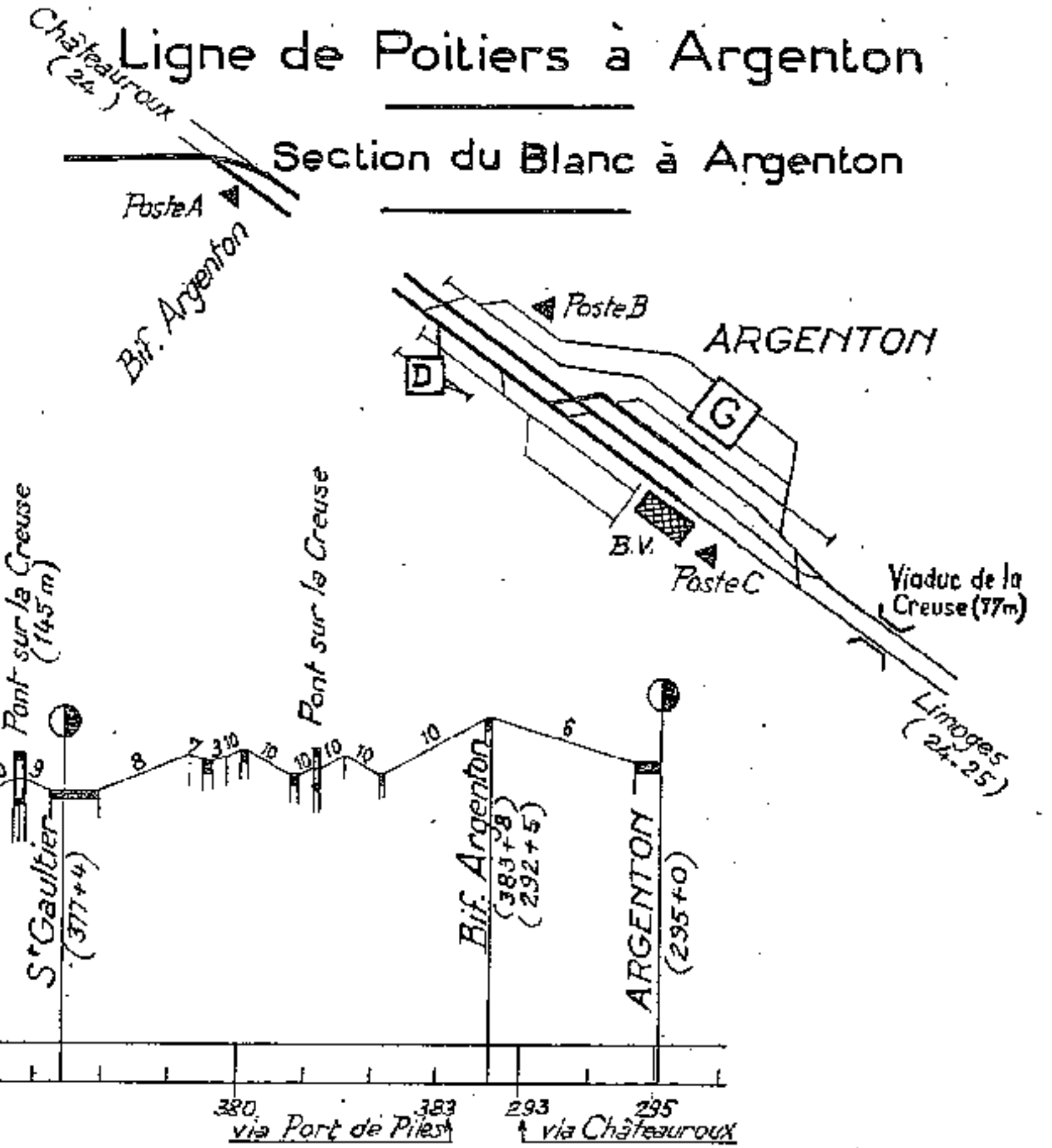

88 MONTMORILLON

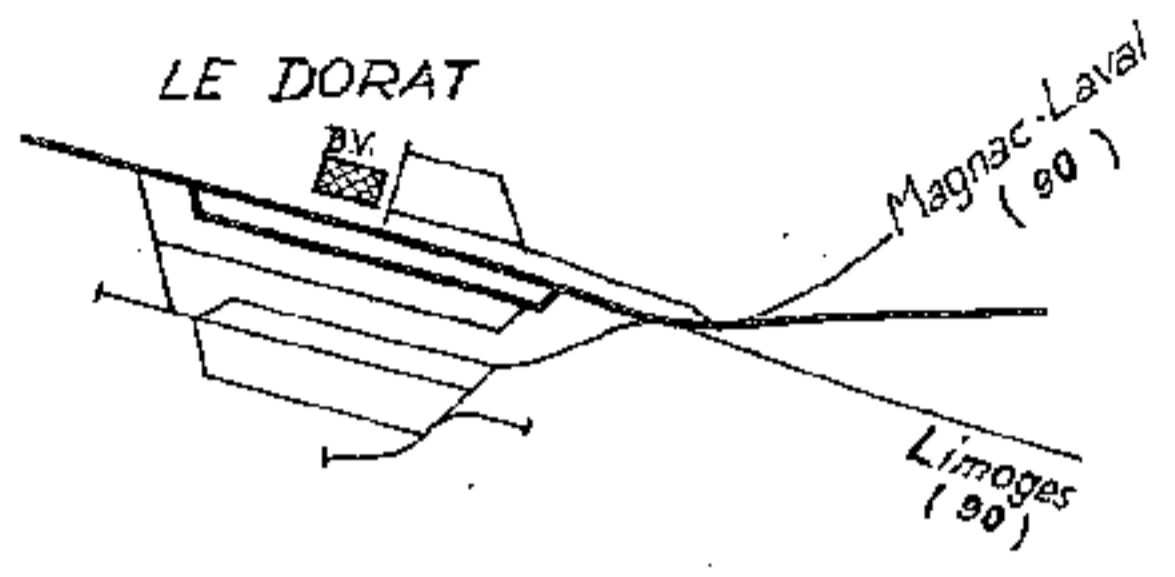
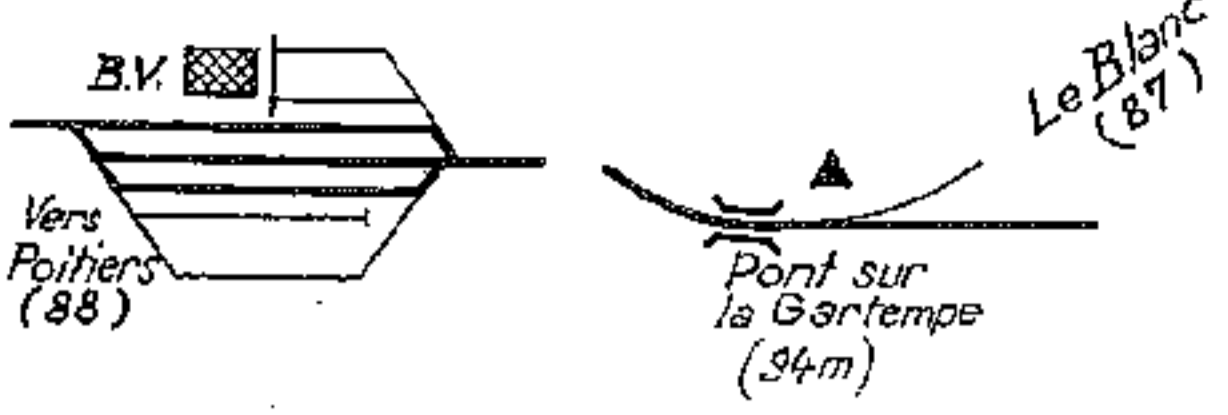

Ligne de Poitiers à S^tSulpice-Laurière
Section de Montmorillon à S^tSulpice-Laurière

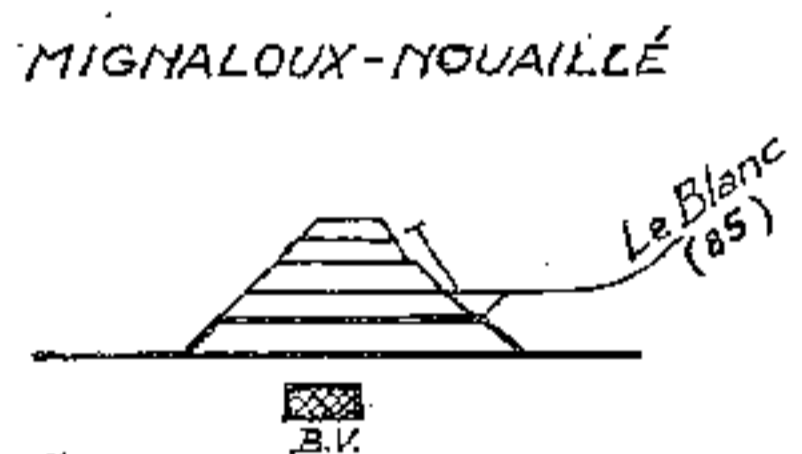
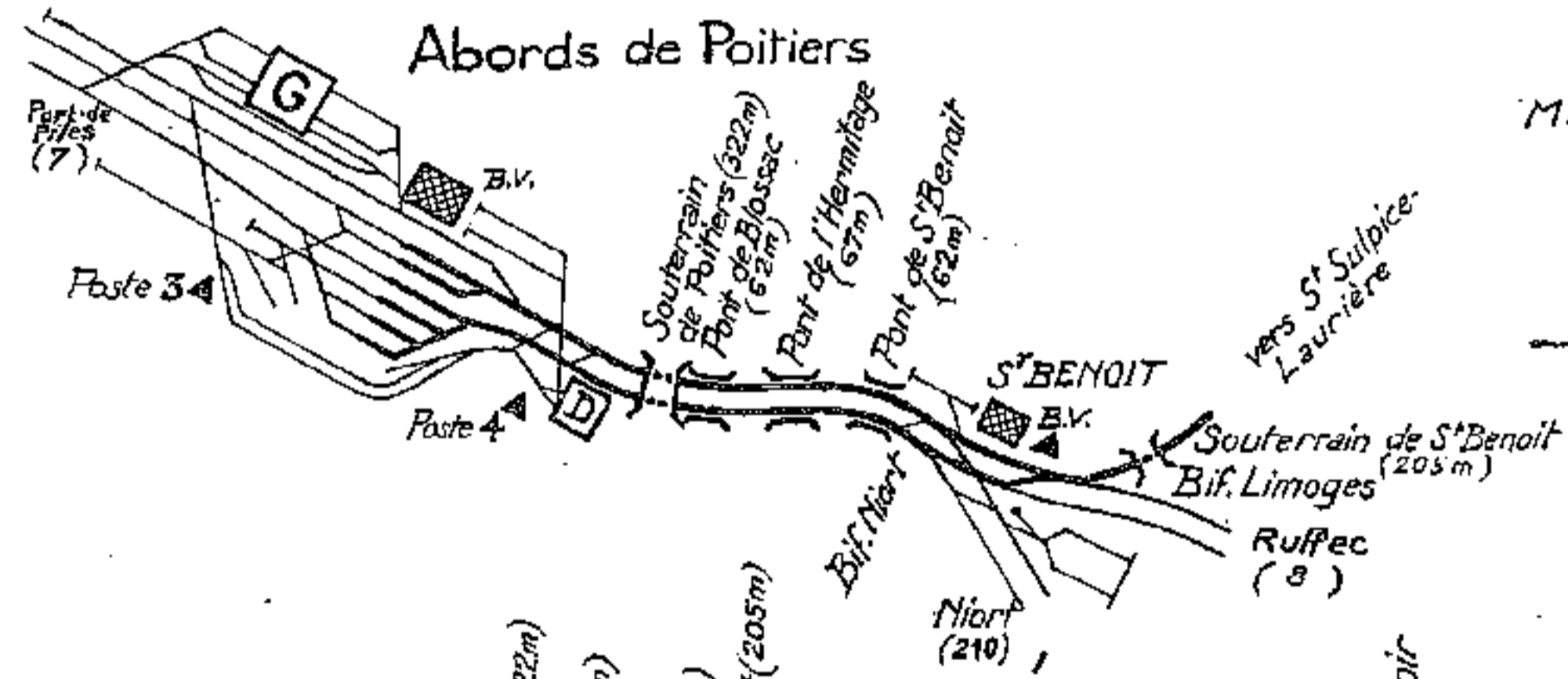
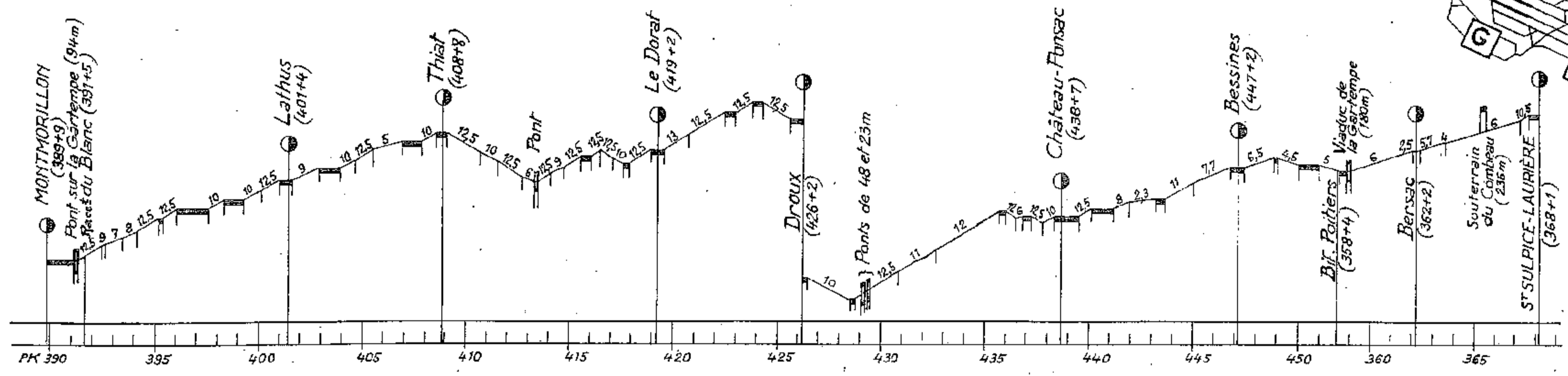
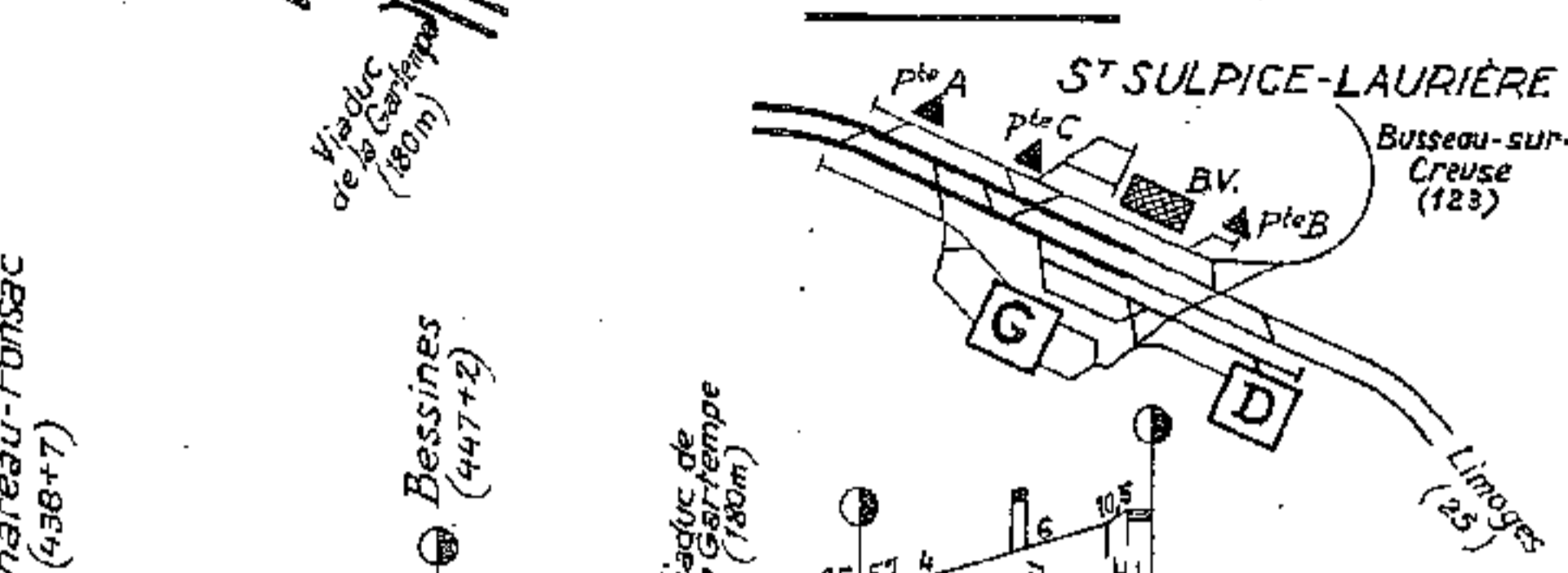

Ligne de Poitiers à S^tSulpice-Laurière
Section de Poitiers à Montmorillon

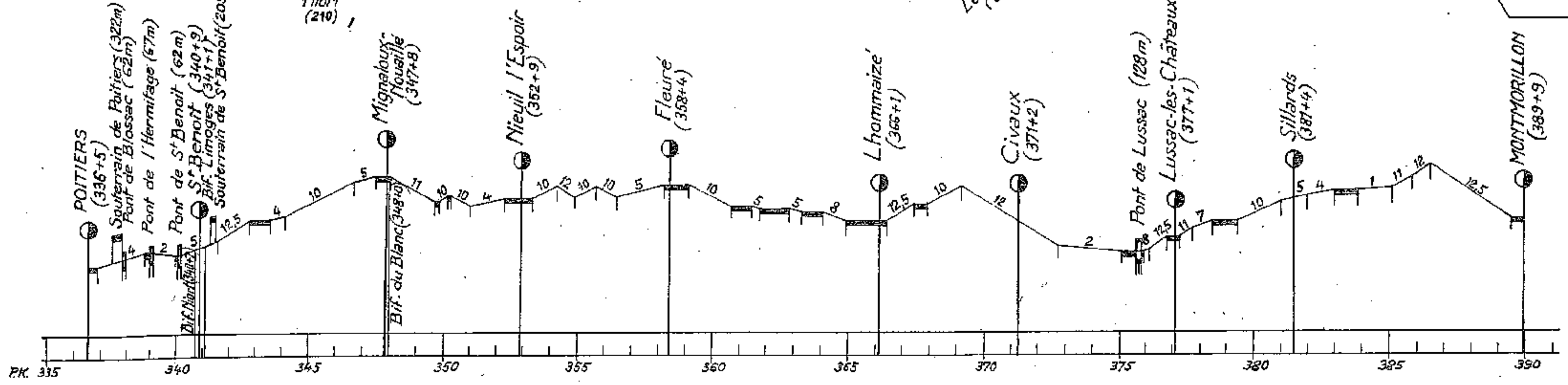
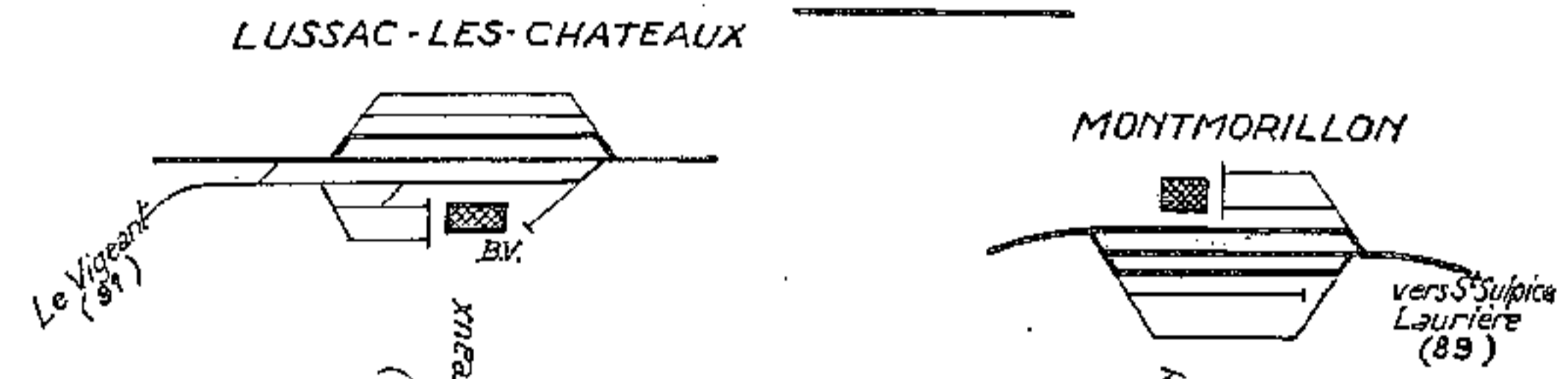

SAINT SAVIOL

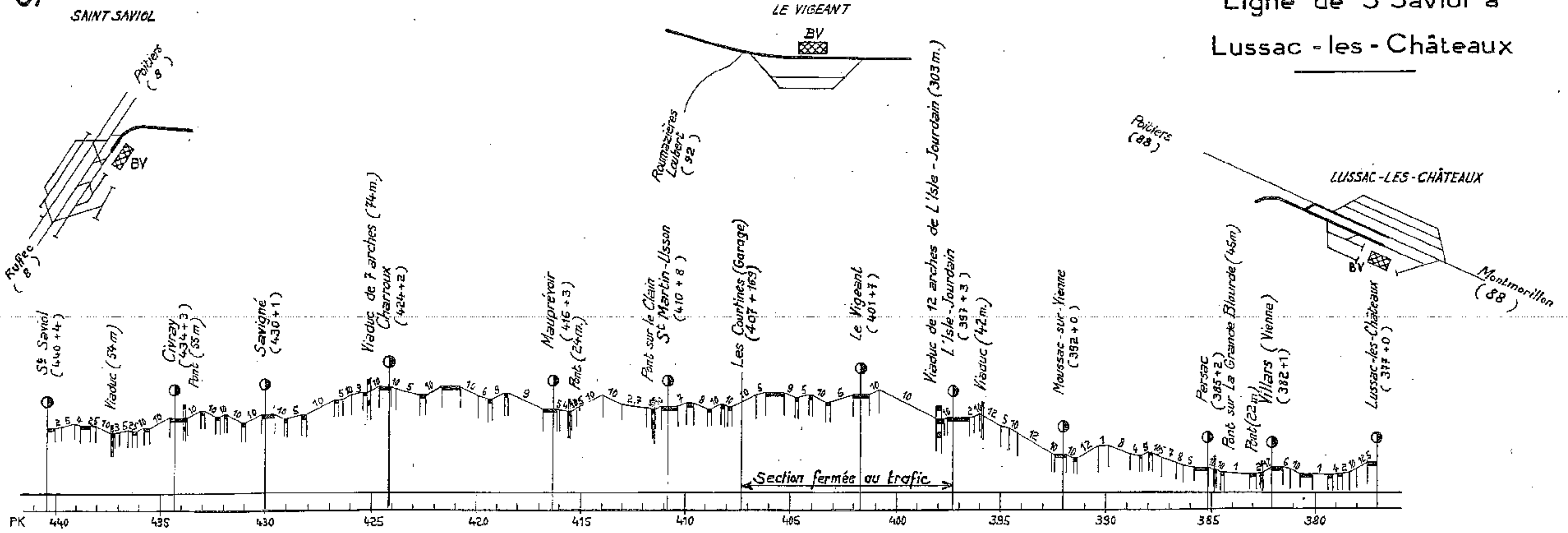
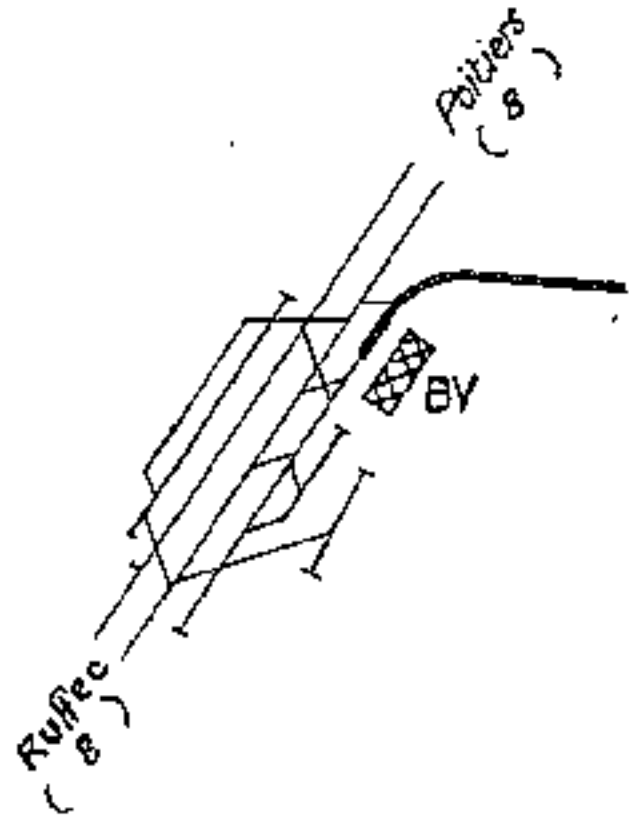

Ligne de S^tSaviol à Lussac - les - Châteaux

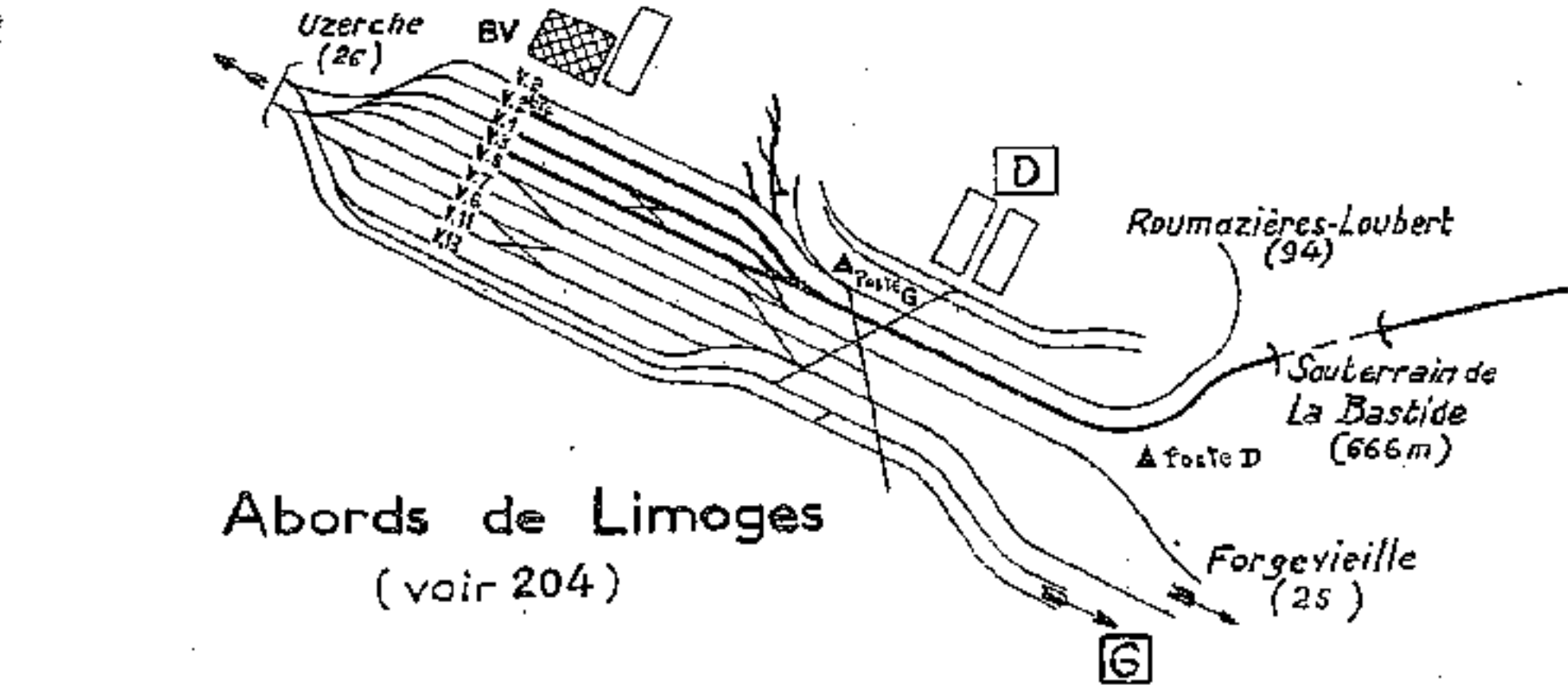

Abords de Limoges (voir 204)

Ligne de Limoges au Dorat et Magnac-Laval.

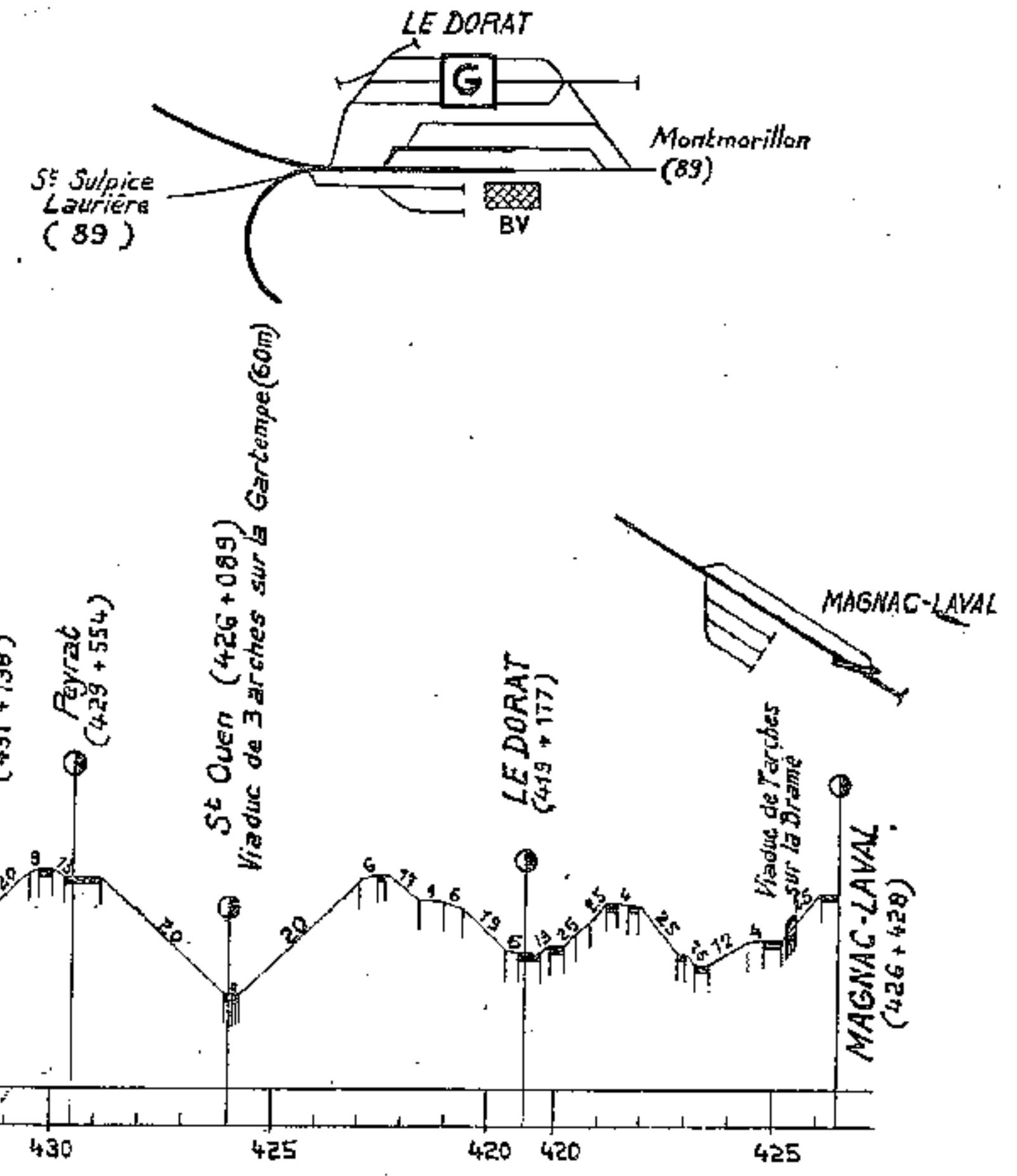

Ligne d'Angoulême à Limoges

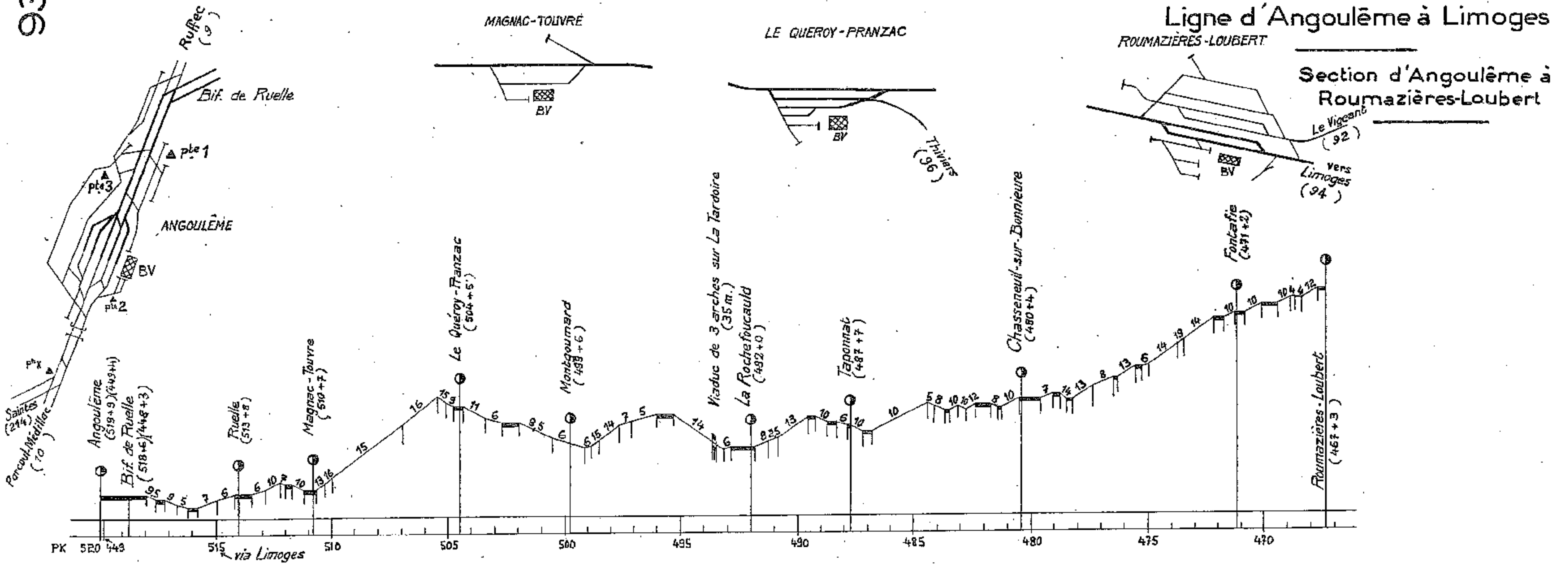

Ligne de Roumazières au Vigeant

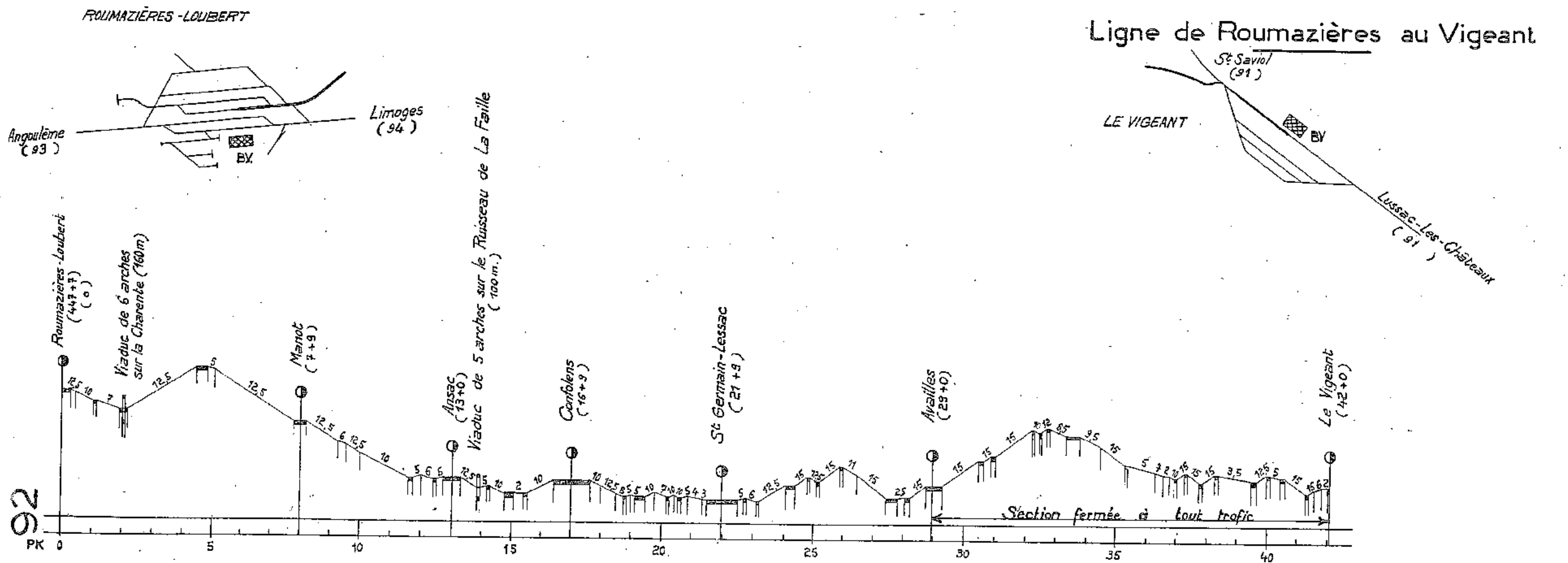

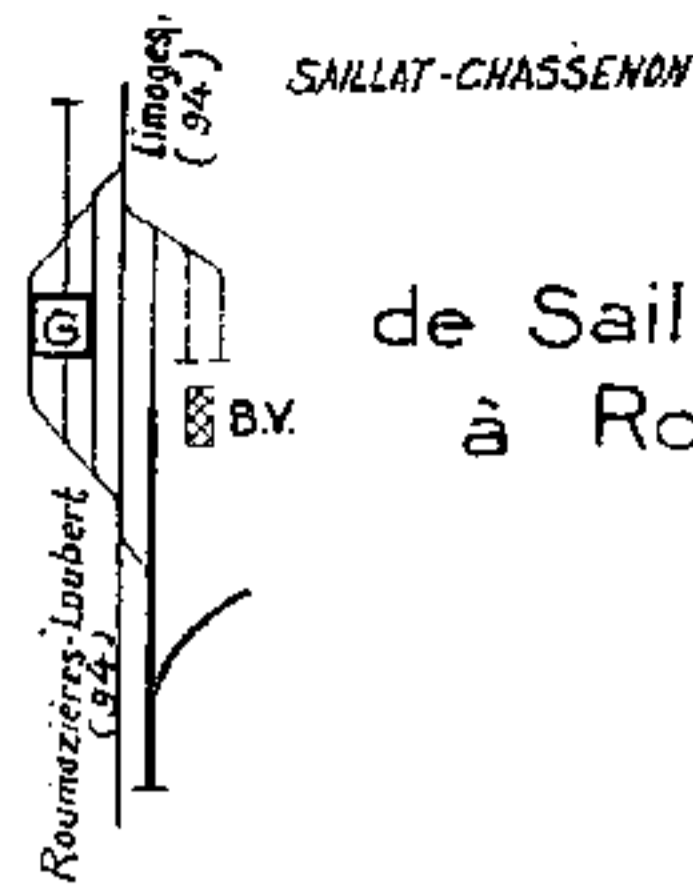

Ligne de Saillat-Chassenon à Rochechouart

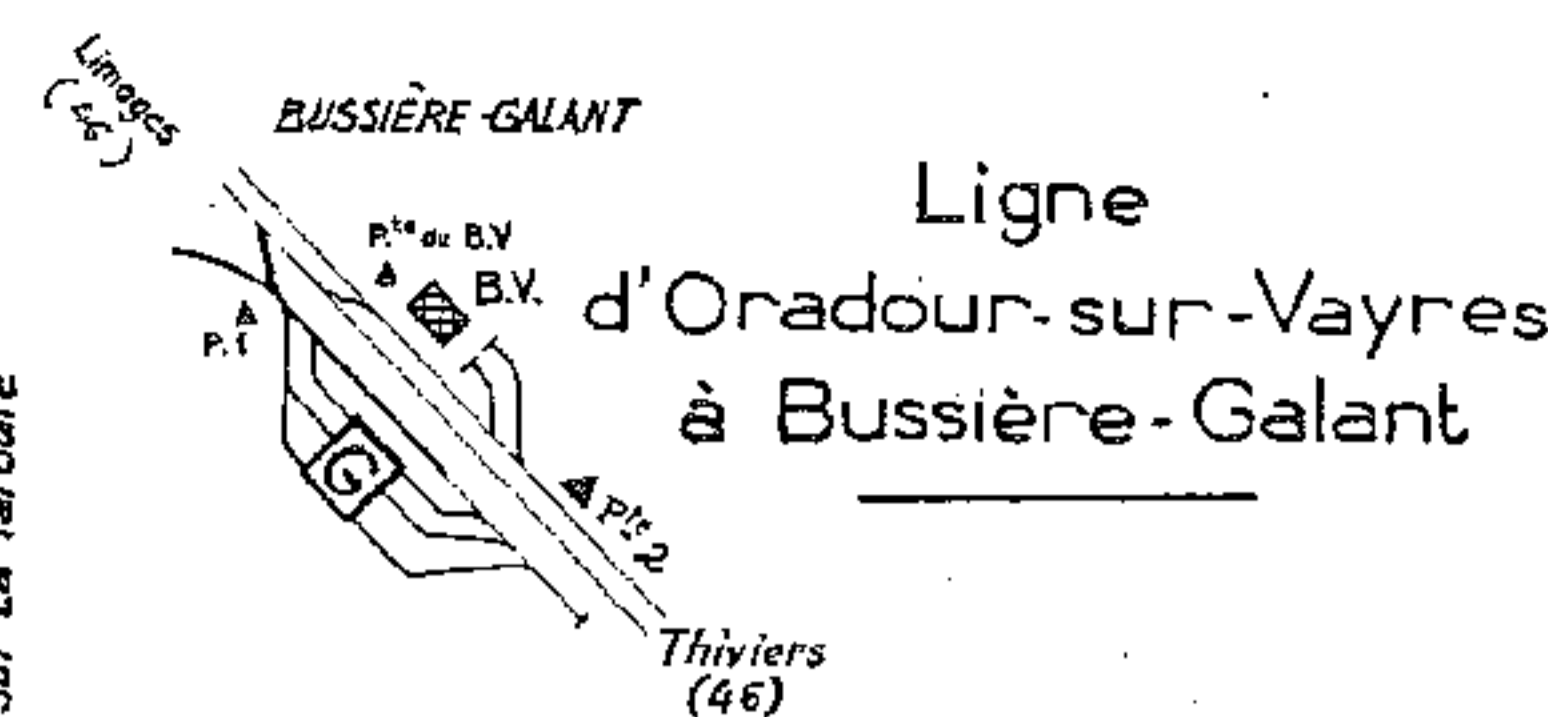
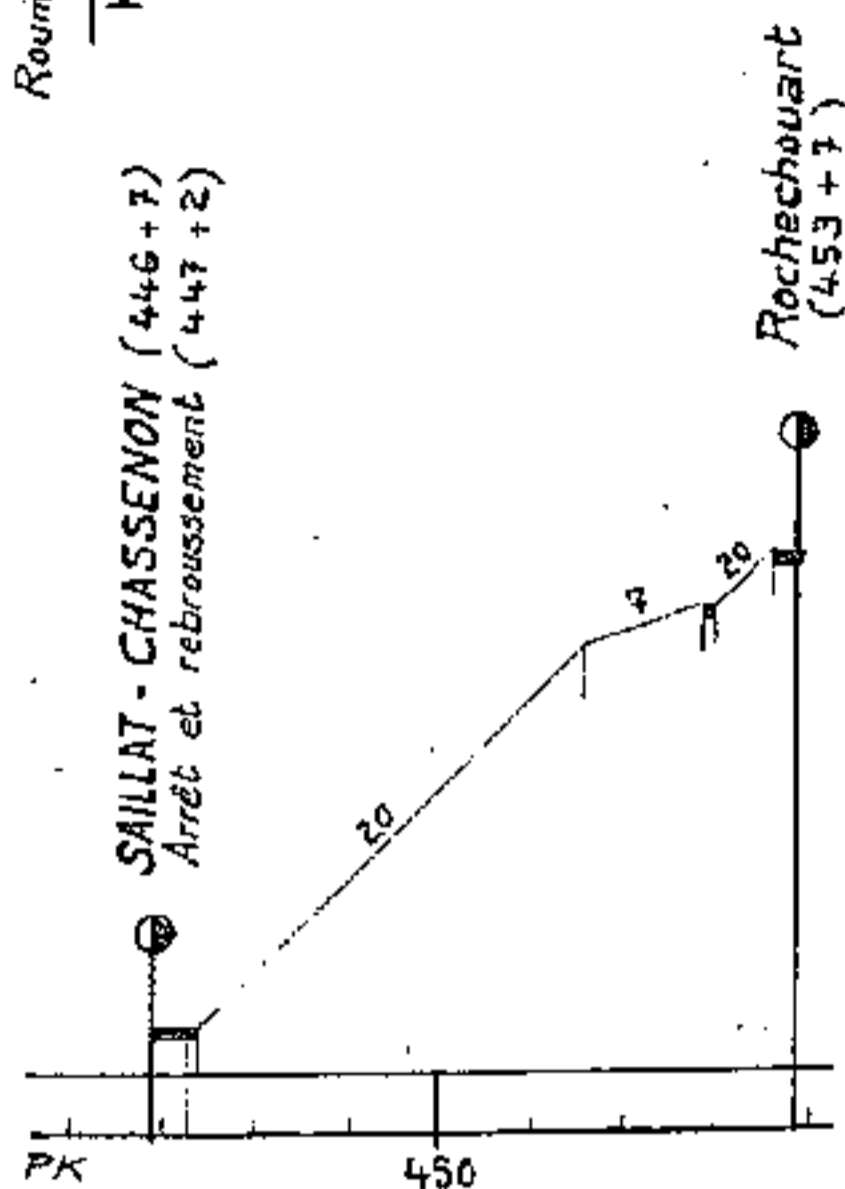

Ligne d'Oradour-sur-Vayres à Bussière-Galant

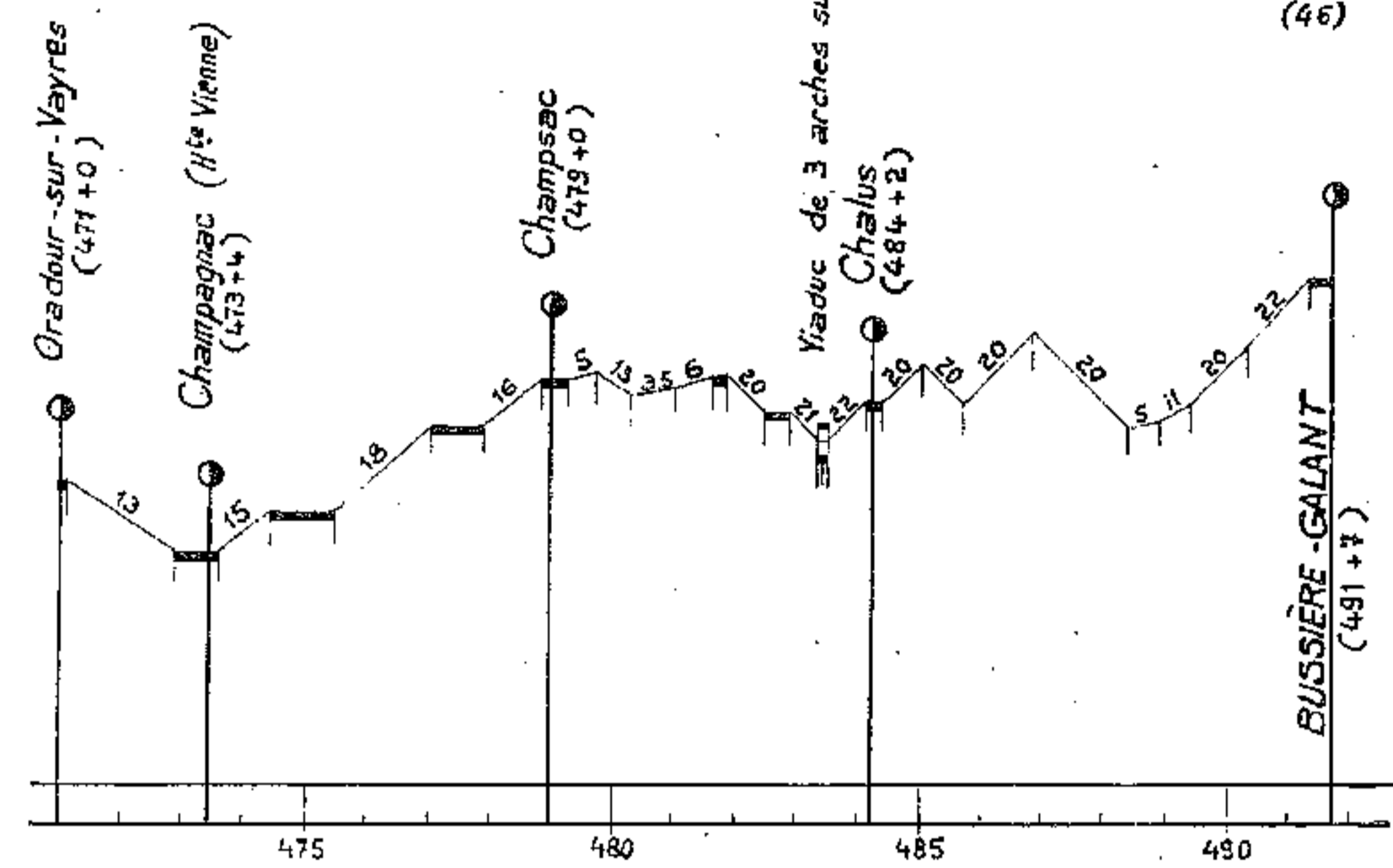

Ligne d'Angoulême à Limoges

Section de Roumazières-Loubert à Limoges-Bénédictins

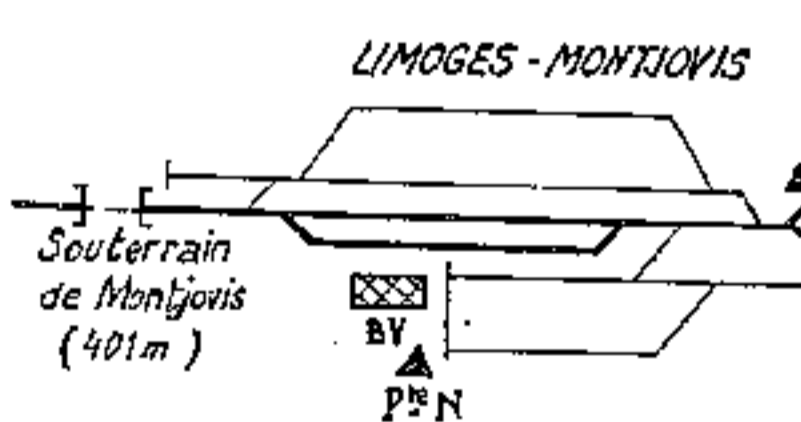
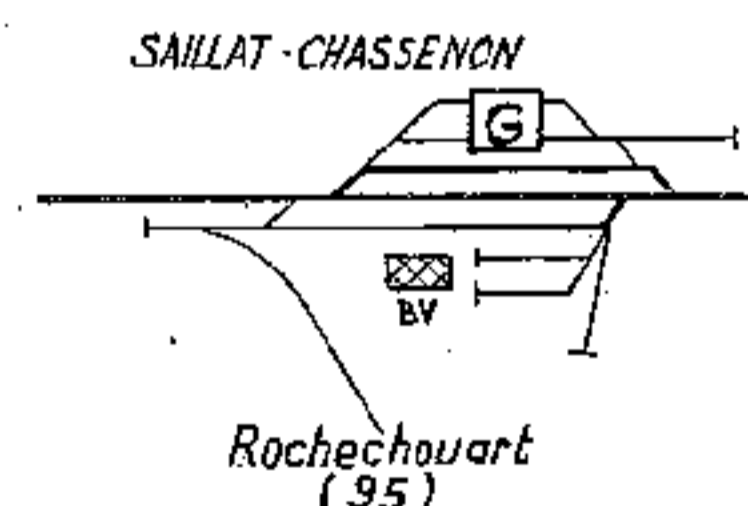
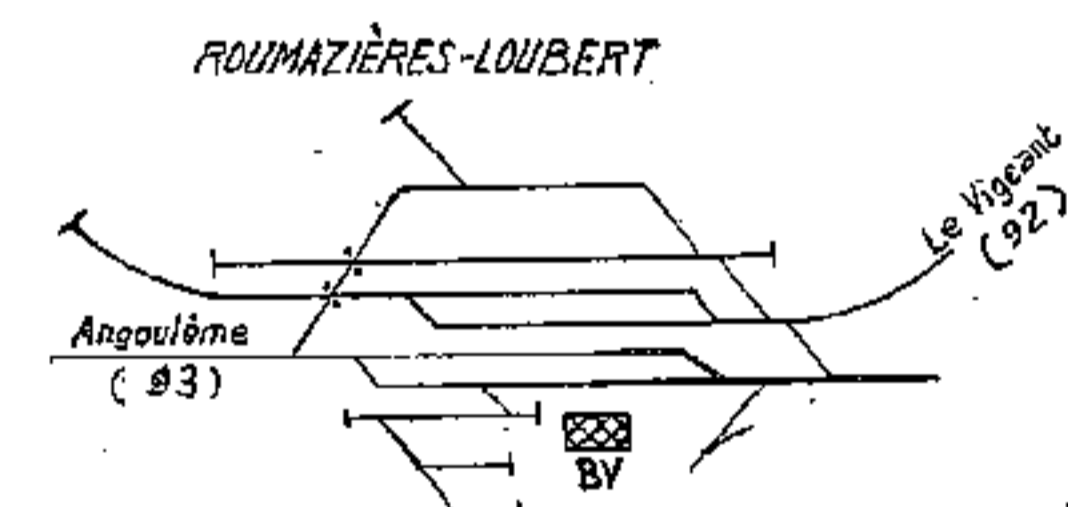

Abords de Limoges (voir 204)

Raccordement de Limoges-Montjovis à Puy-Imbert

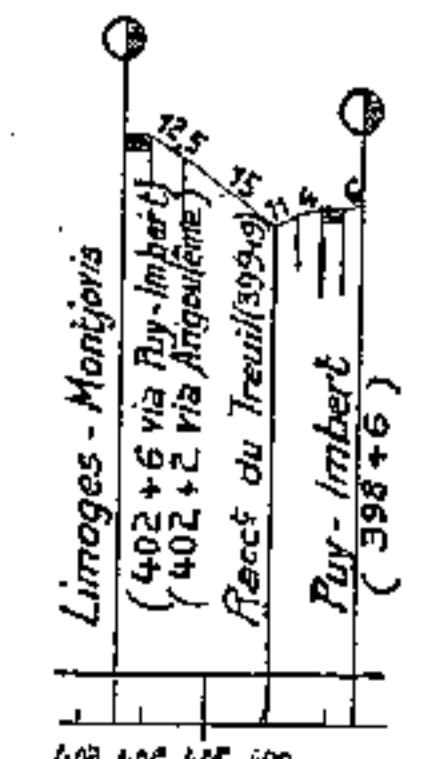
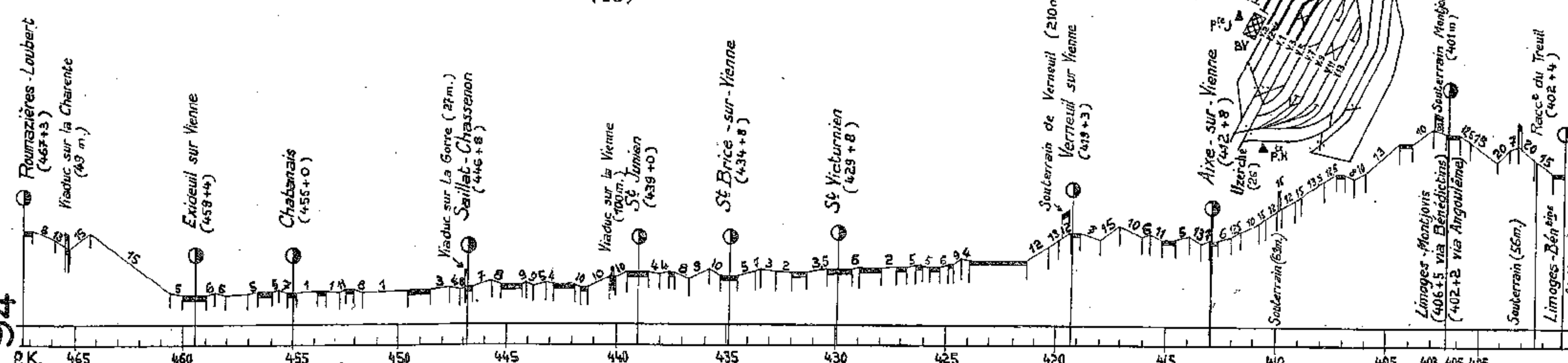

Abords de Nexon

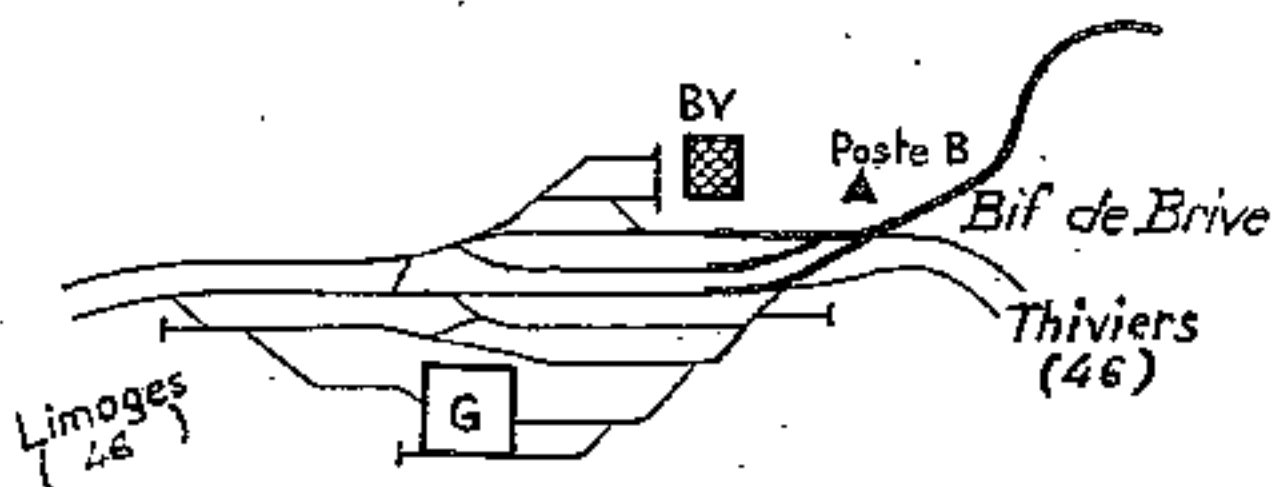

Abords de St Yrieix

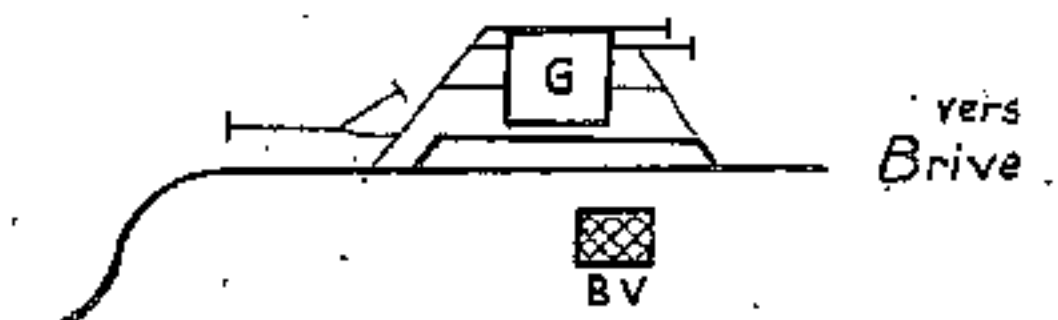

Ligne de Nexon à Brive

Section de Nexon à Lubersac

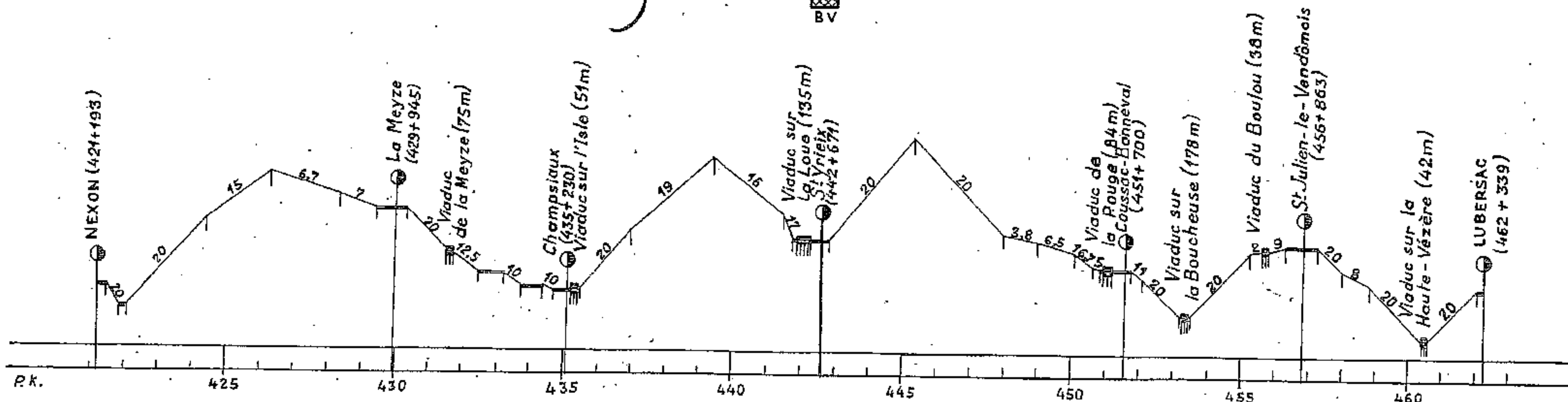

Ligne de Le Quéroy-Pranzac à Thiviers

LE QUÉROY-PRANZAC

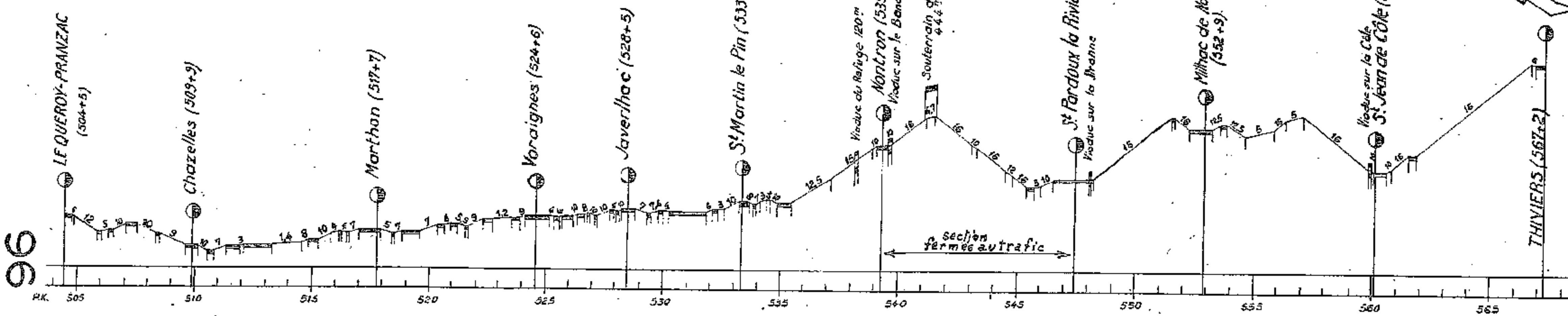
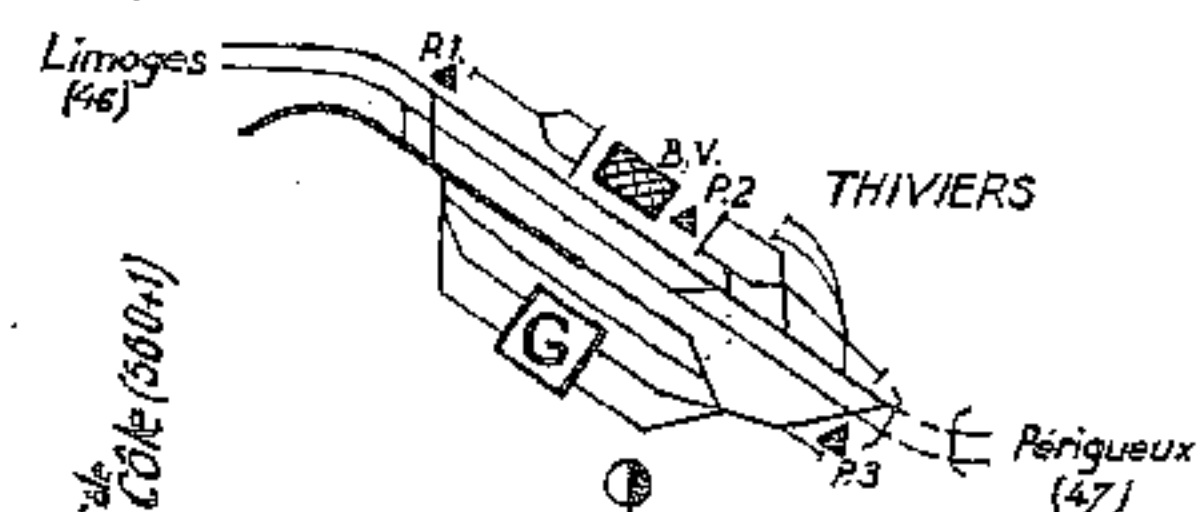
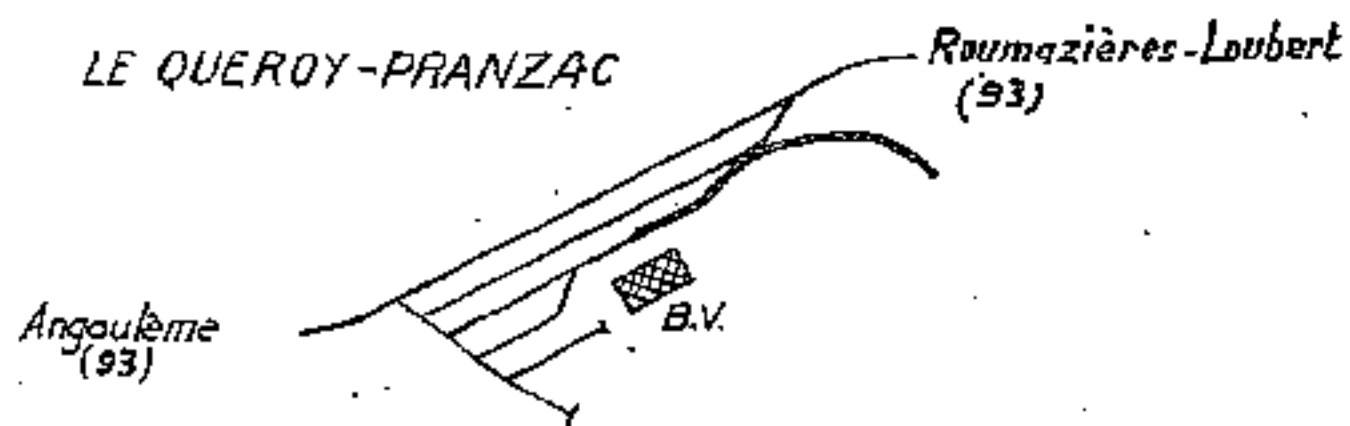

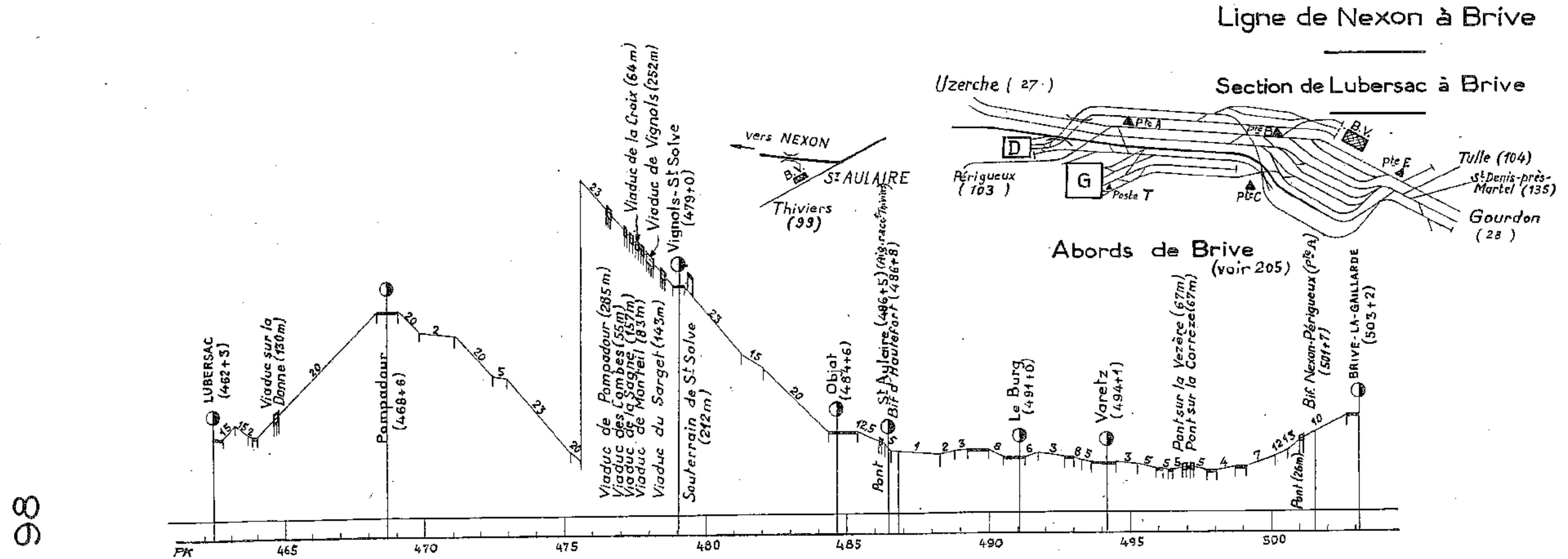
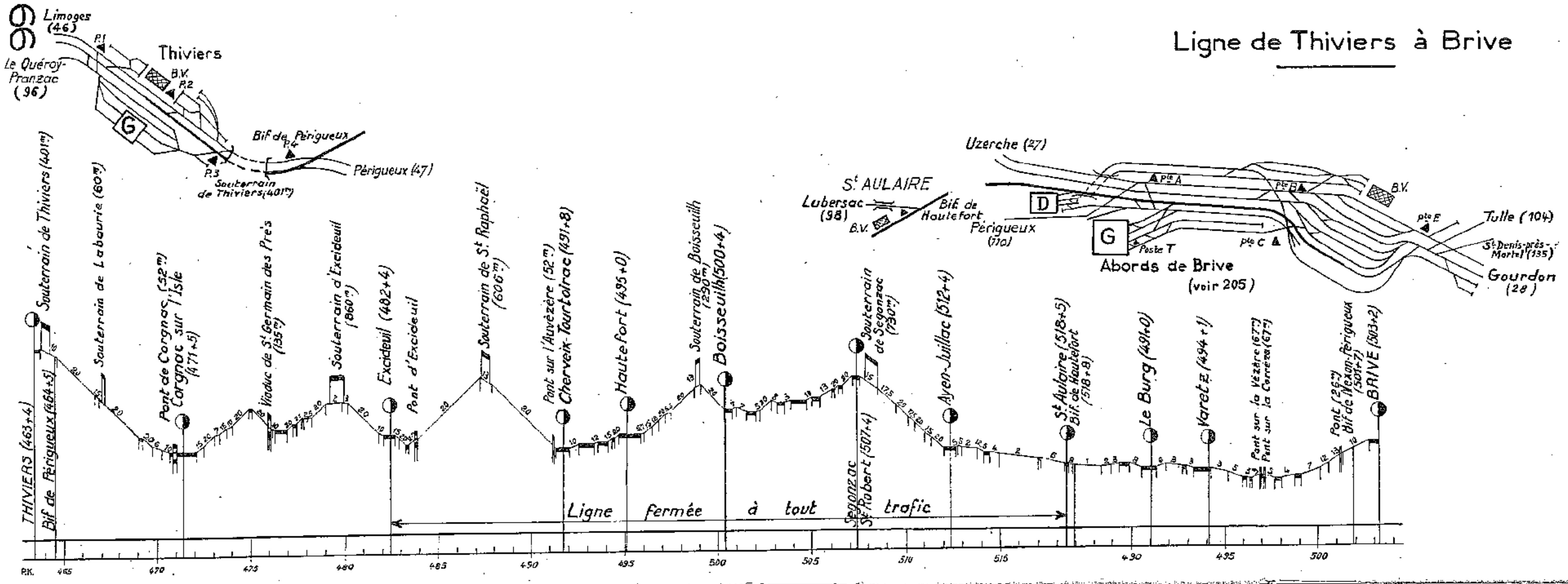

LE BUISSON

SIORAC (Bif. Sarlat)

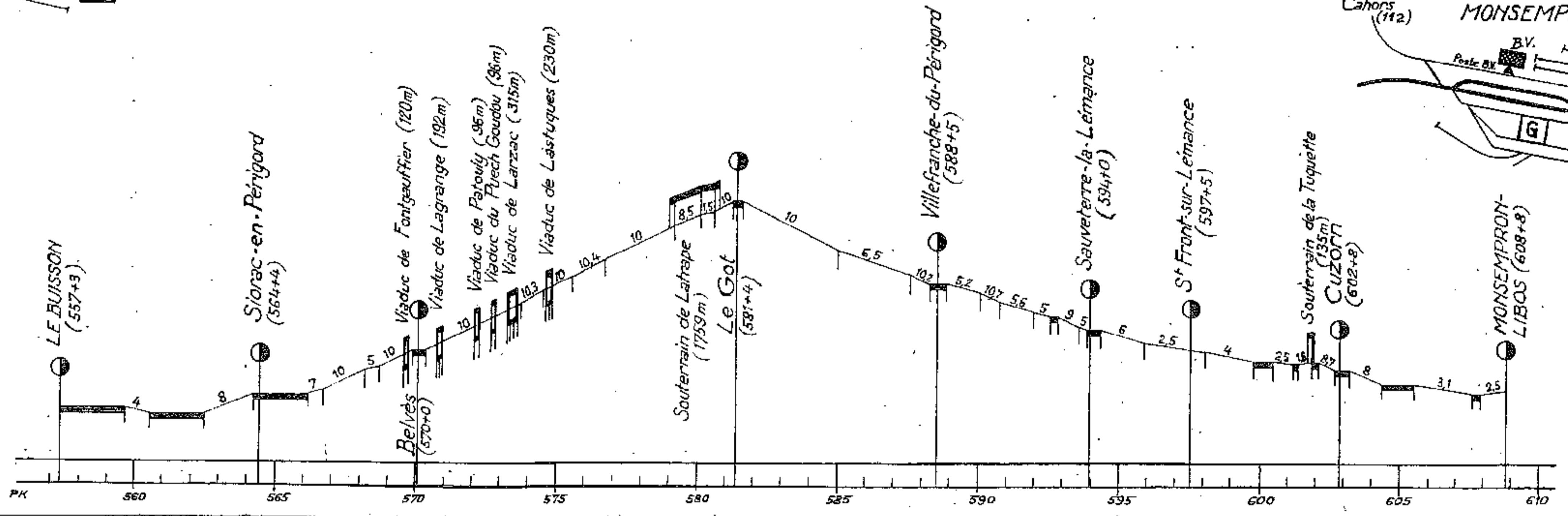
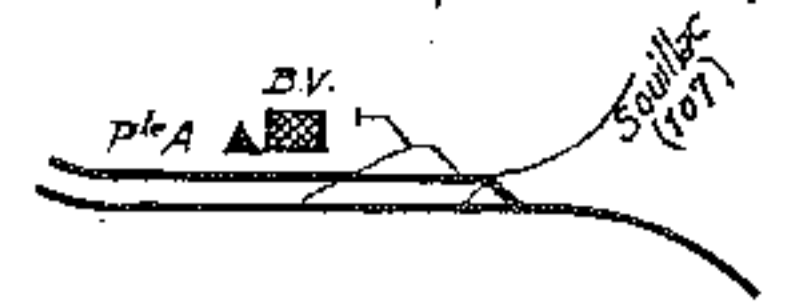
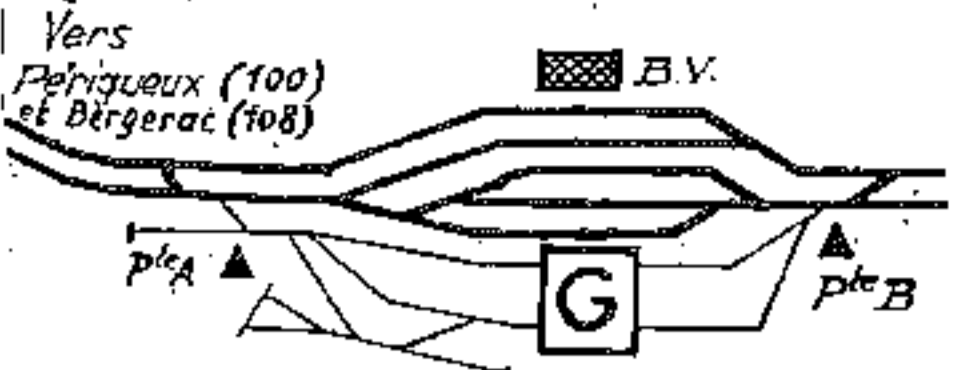

Ligne de Périgueux à Agen
Section du Buisson à Monsempron-Libos

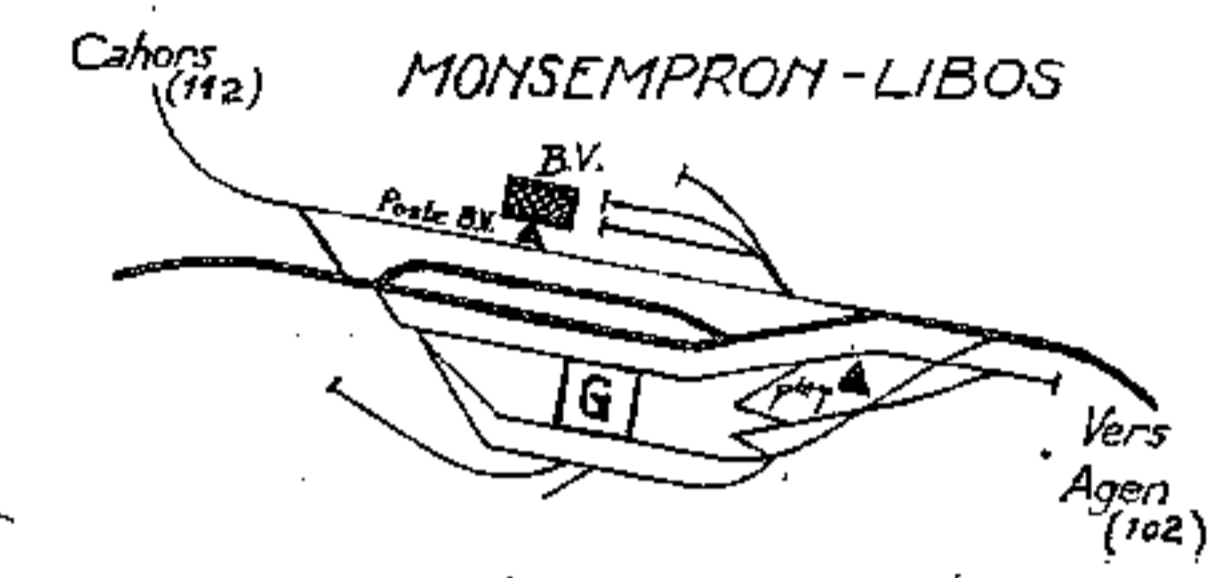

Abords de Périgueux

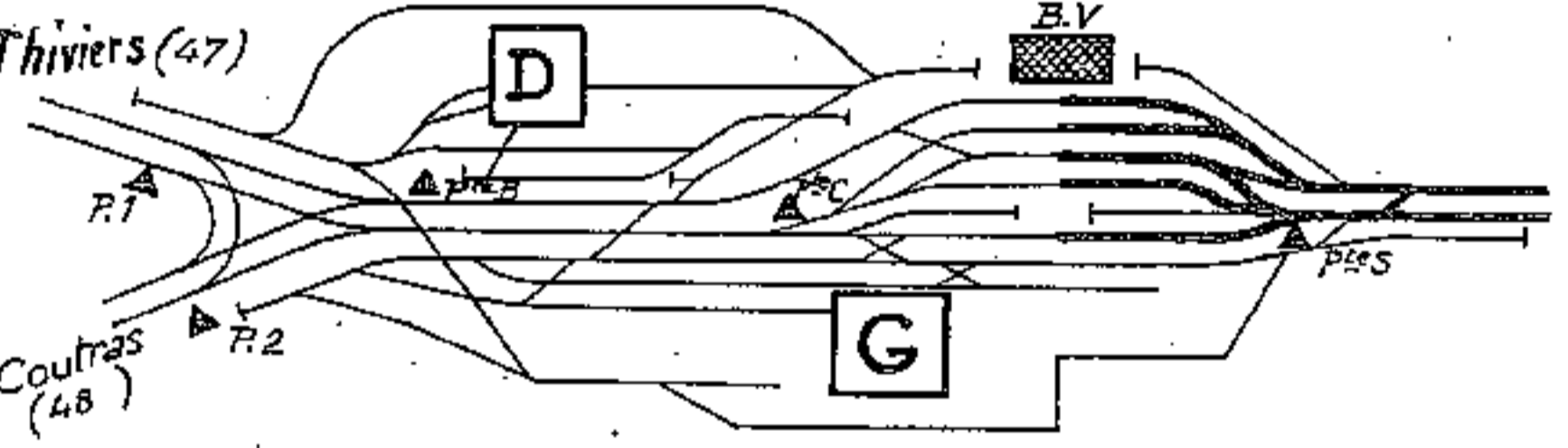

NIVERSAC

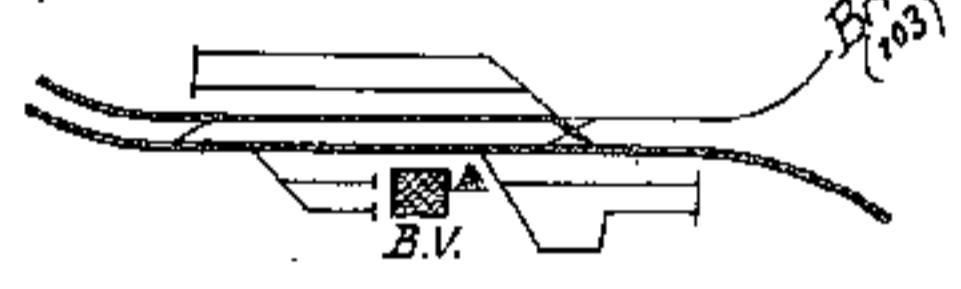

Ligne de Périgueux à Agen
Section de Périgueux au Buisson

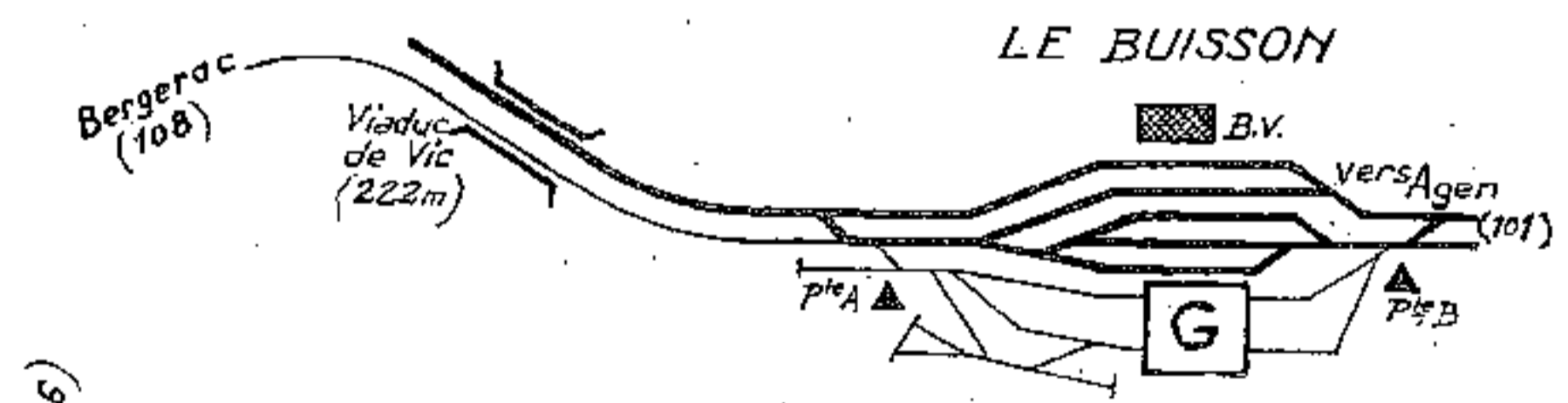
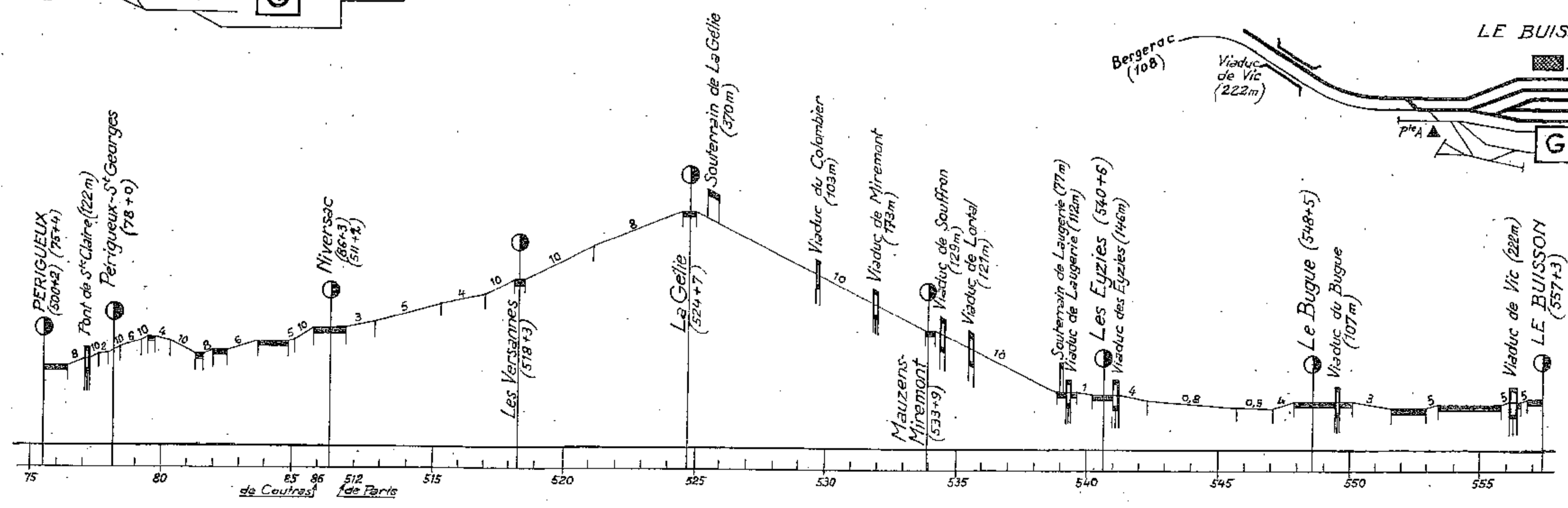

Abords de Périgueux

Ligne de Périgueux à Brive

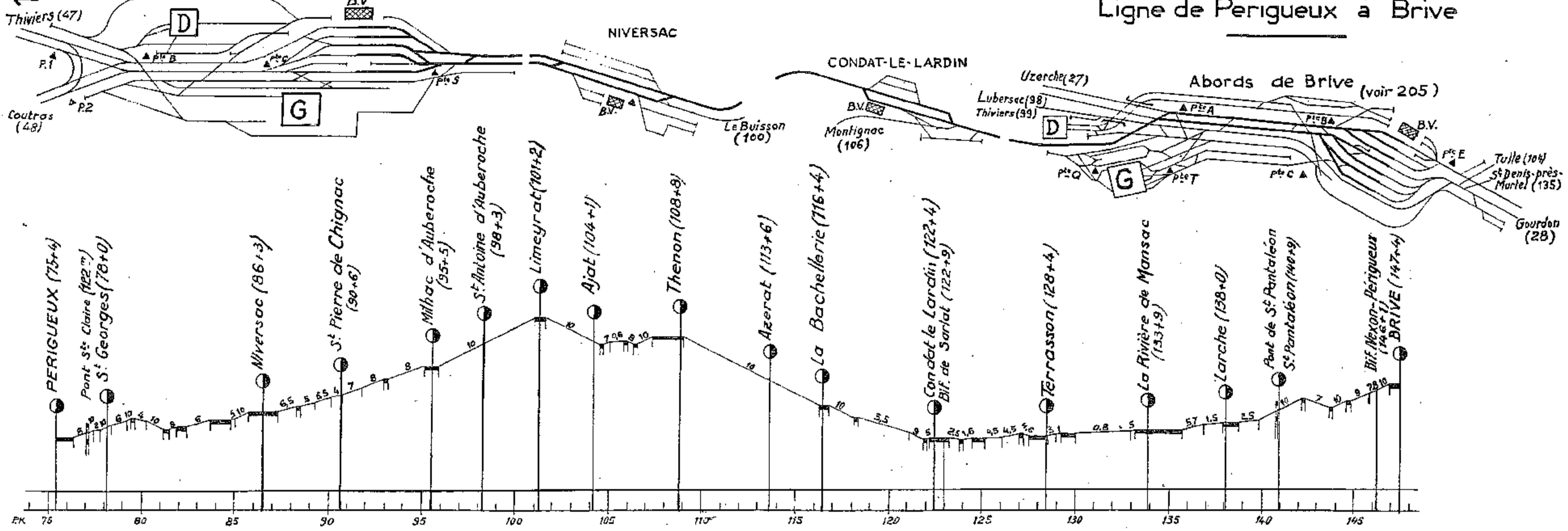

Ligne de Périgueux à Agen

Section de Monsempron-Libos à Agen

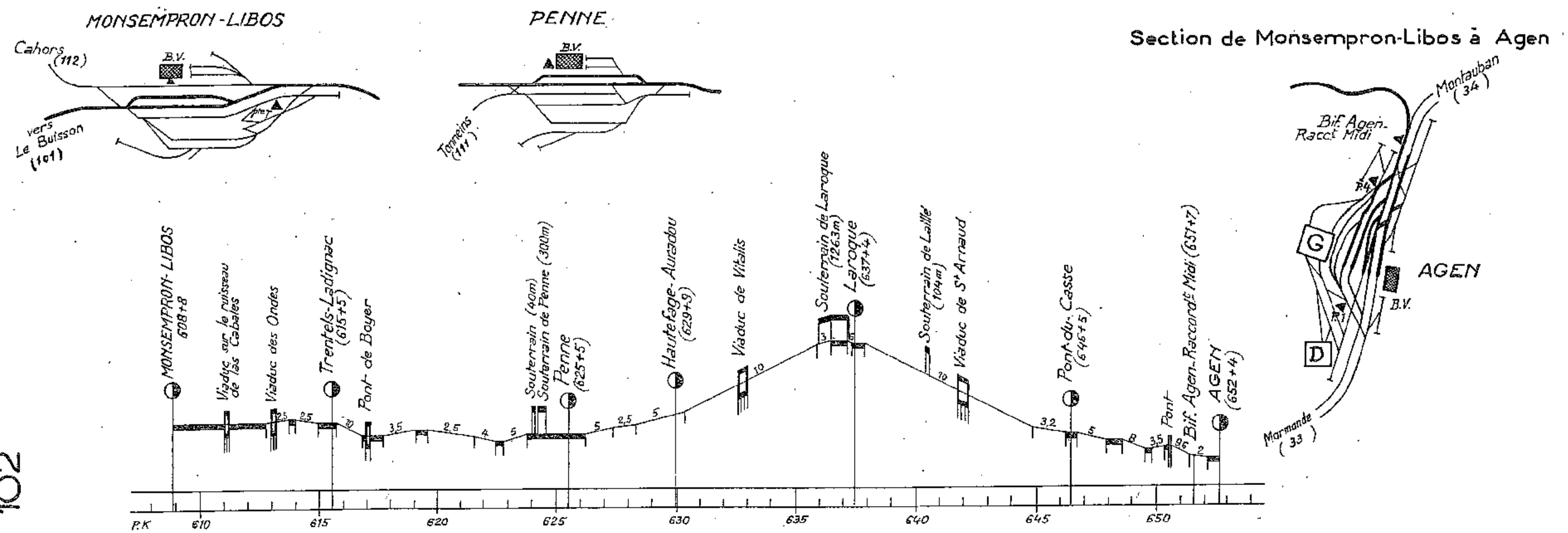

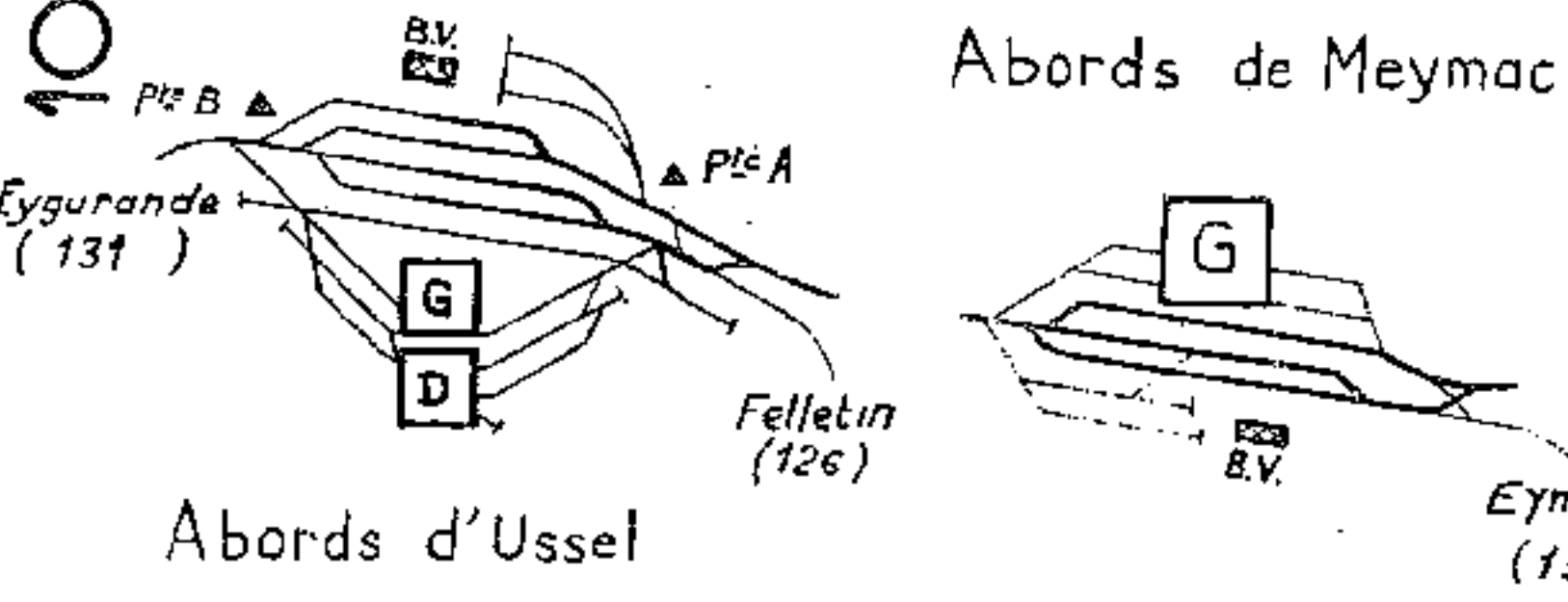

Abords de Tulle Ligne d'Ussel à Brive

Section d'Ussel à Tulle

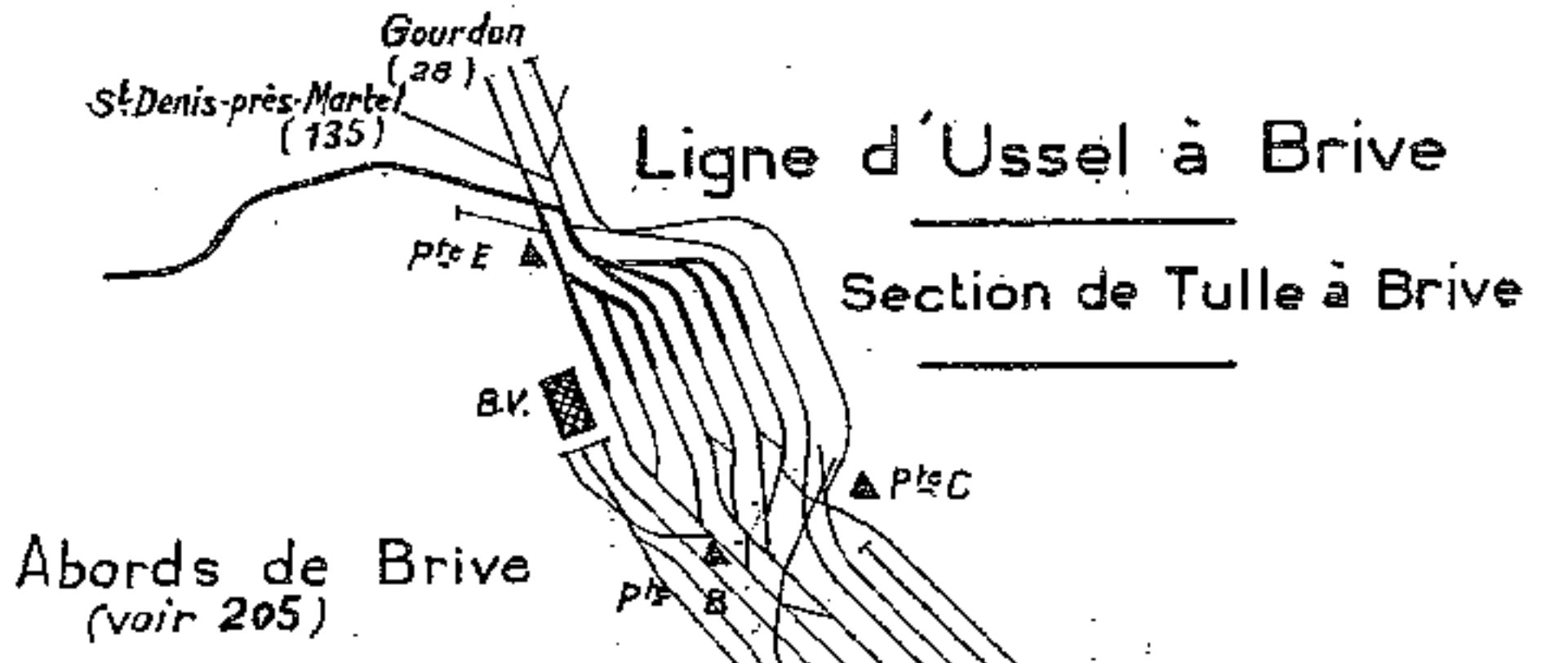
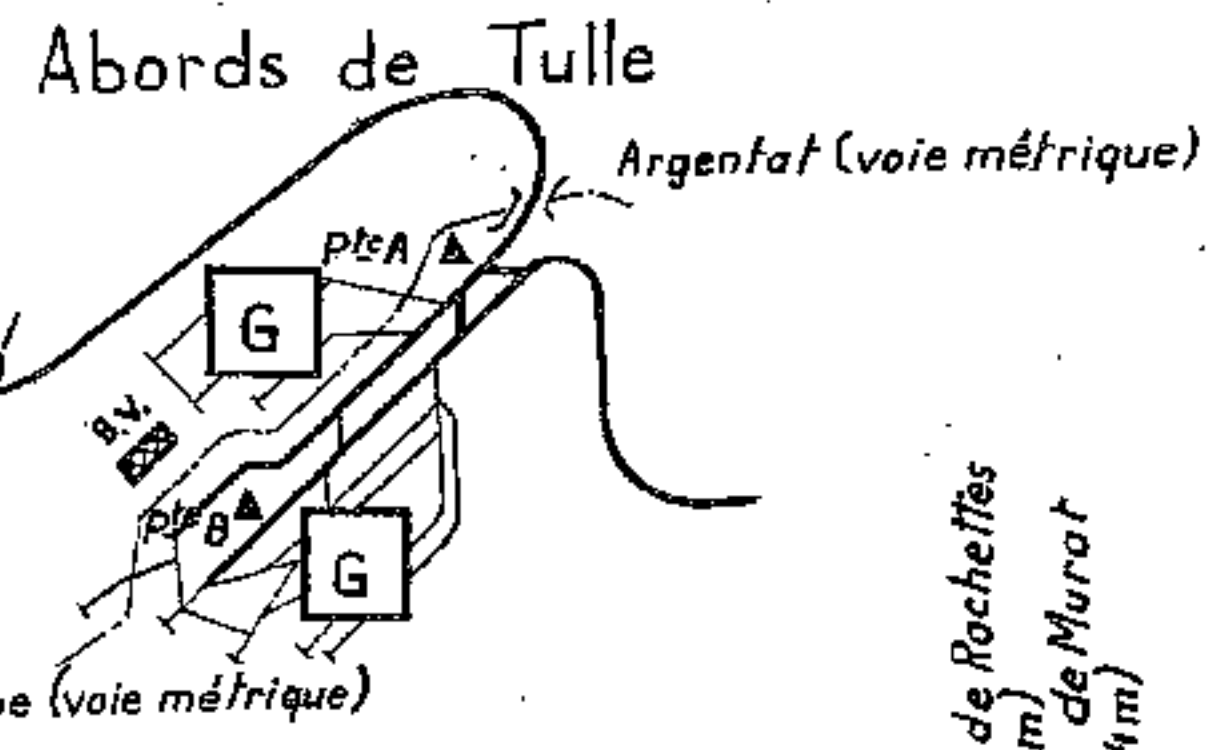
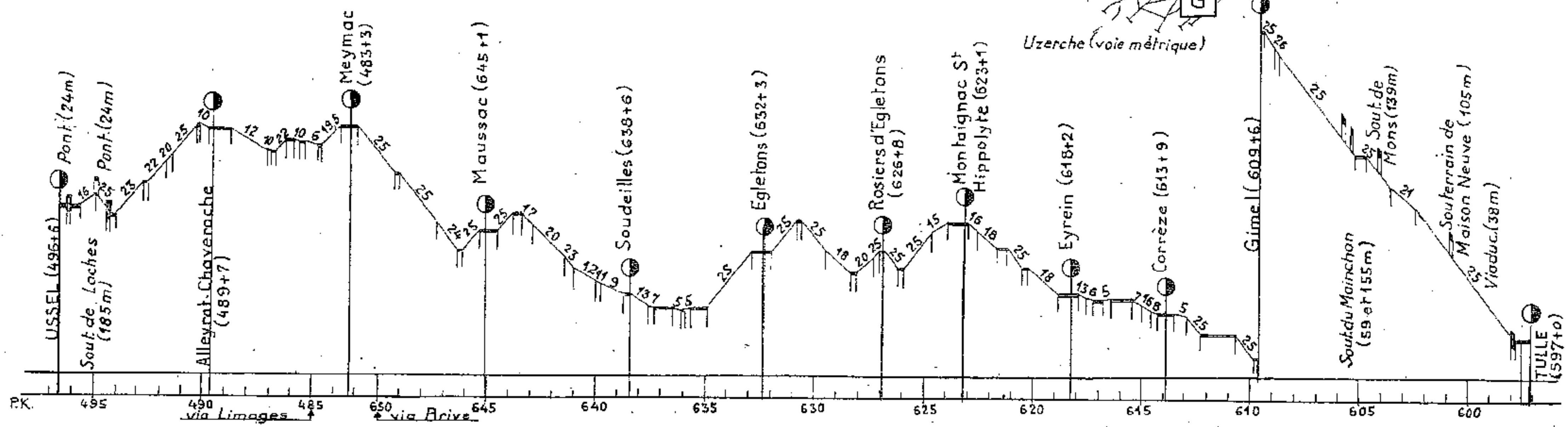
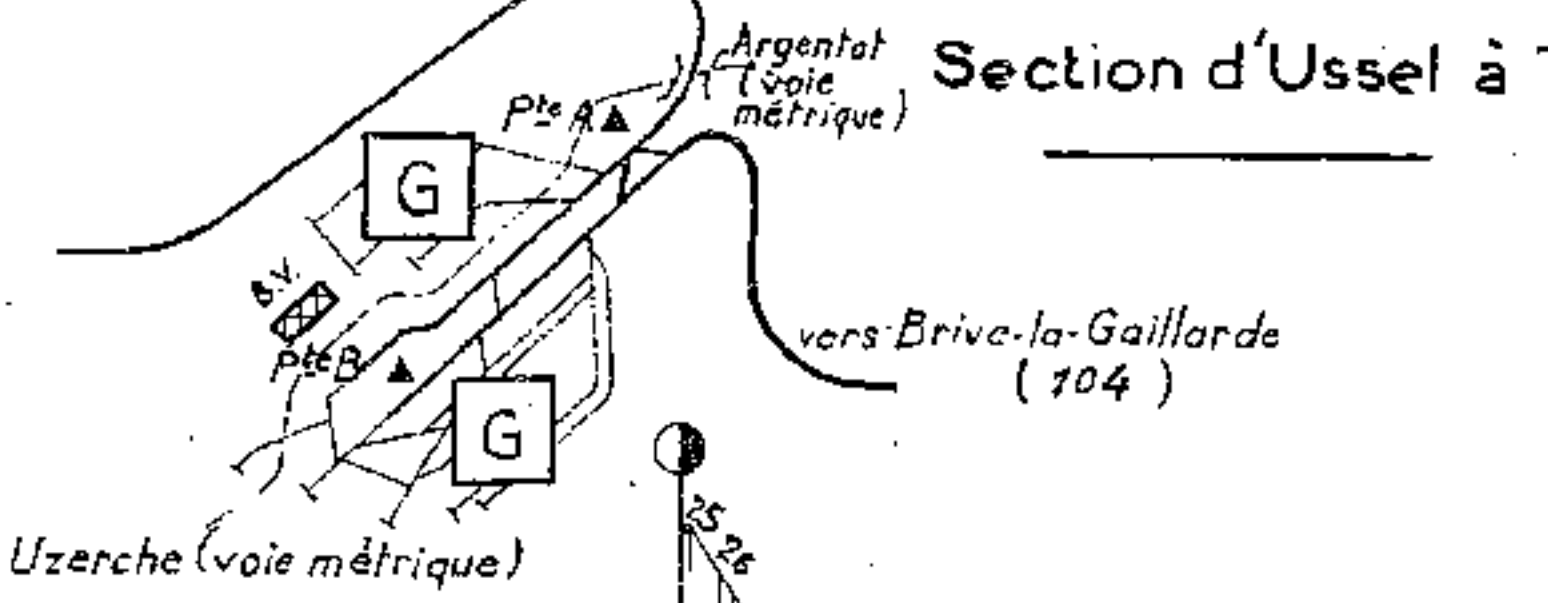

Ligne d'Ussel à Brive

Section de Tulle à Brive

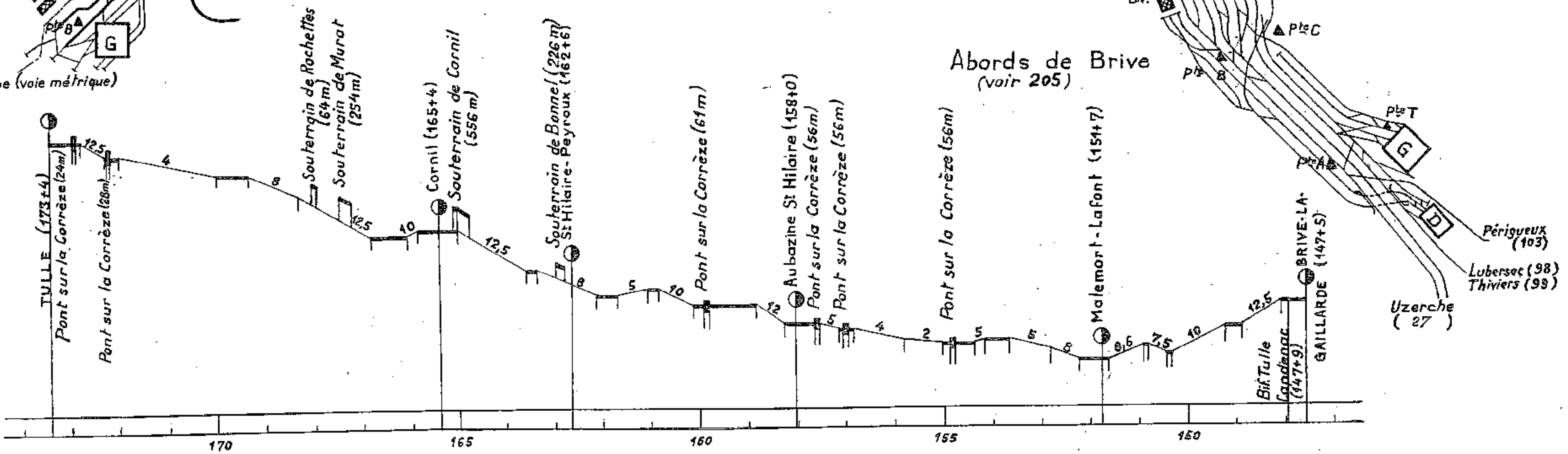

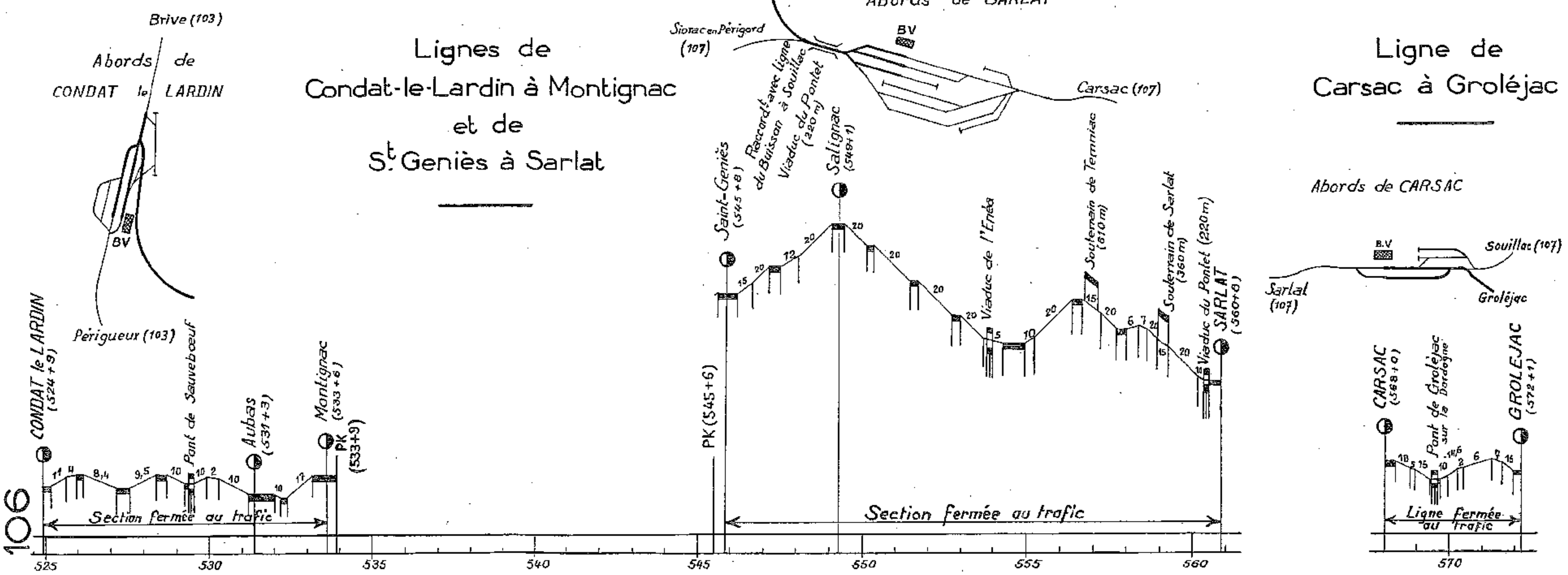
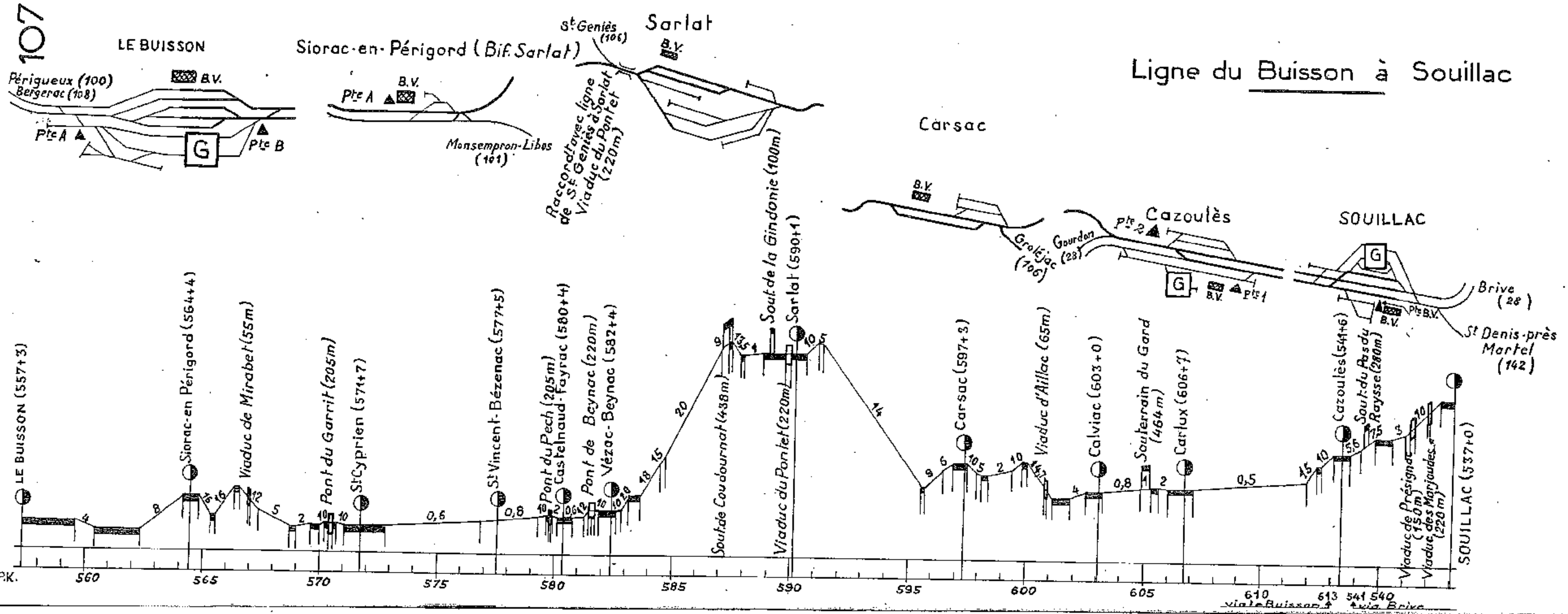

Abords de Bergerac

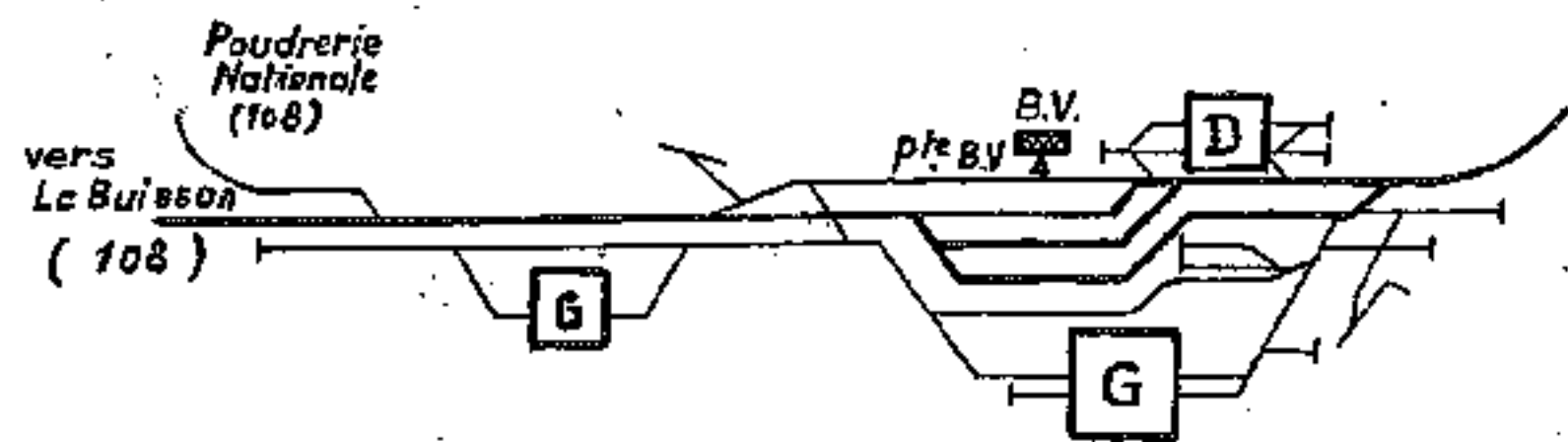

Ligne du Buisson à Libourne

Section de Bergerac à Libourne

Abords de Libourne

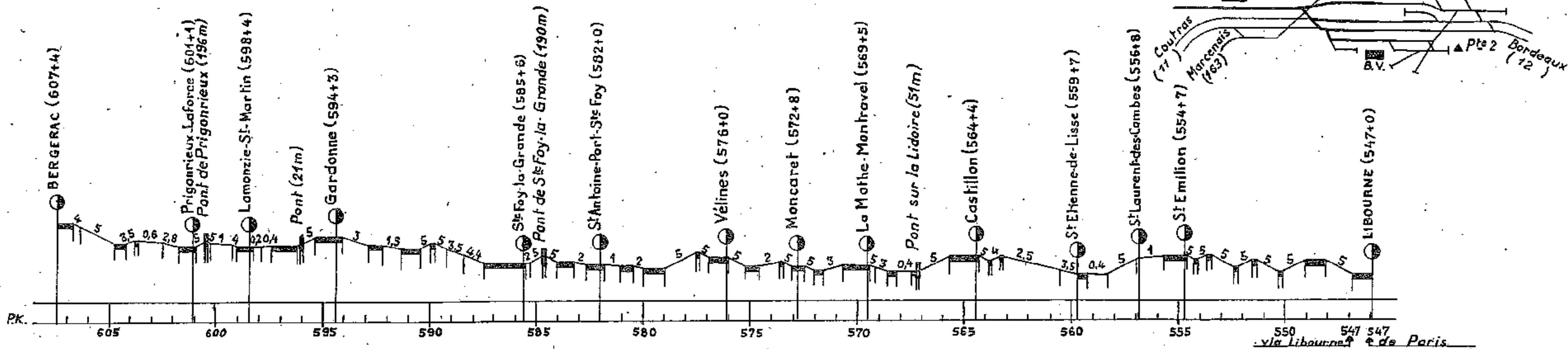

Le Buisson

Ligne du Buisson à Libourne

Section du Buisson à Bergerac

Ligne de Bergerac à la Poudrerie Nationale

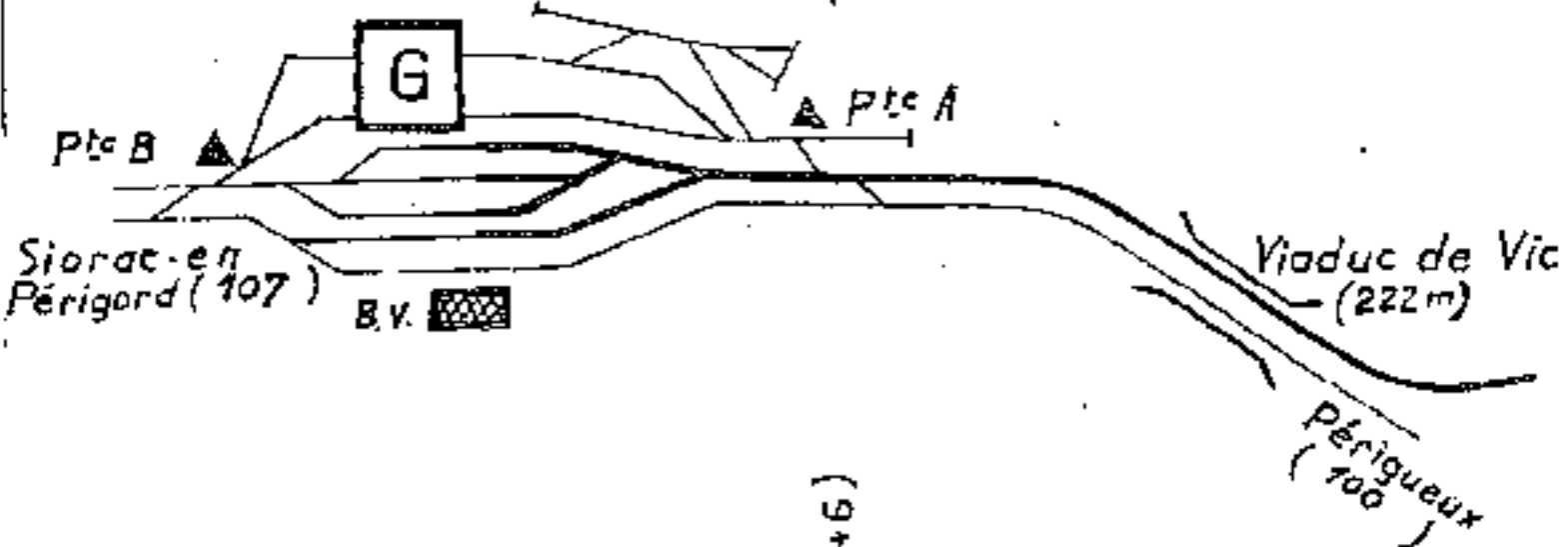

Abords de Bergerac

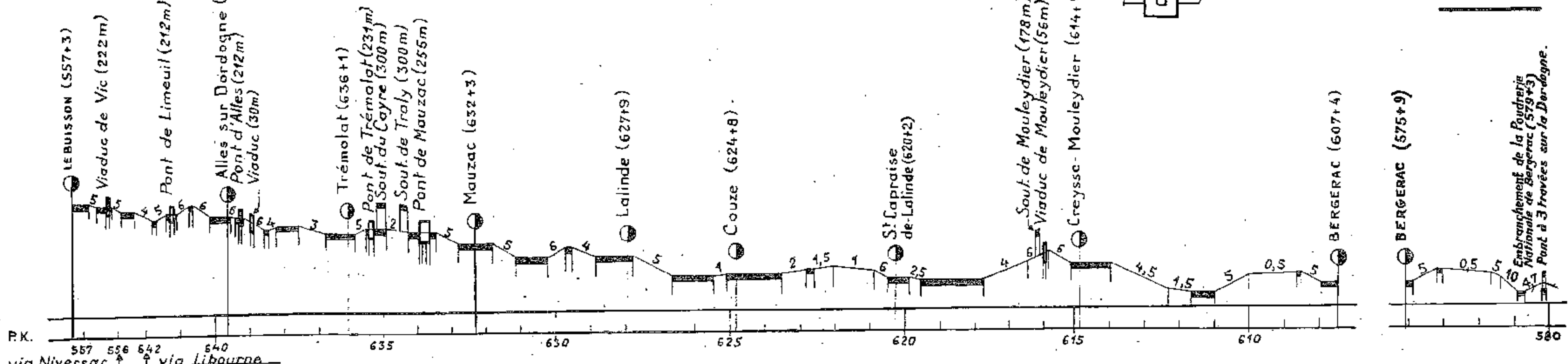
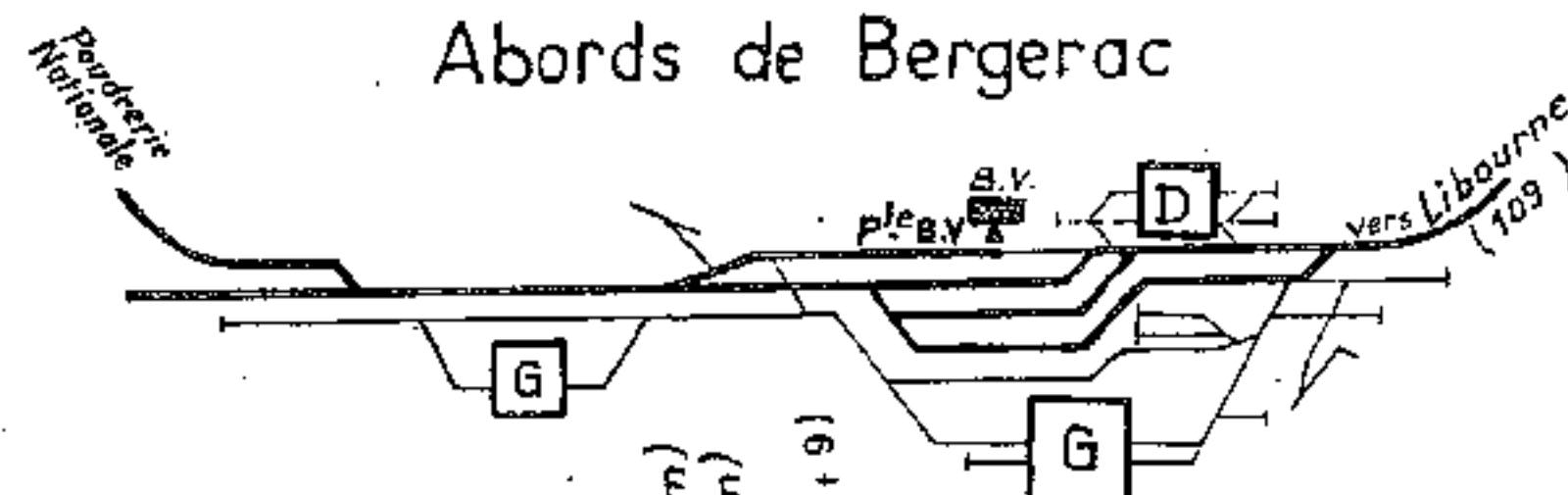

Embranchement de la Poudrerie Nationale de Bergerac (579+3) Pont à 3 travées sur la Dordogne.

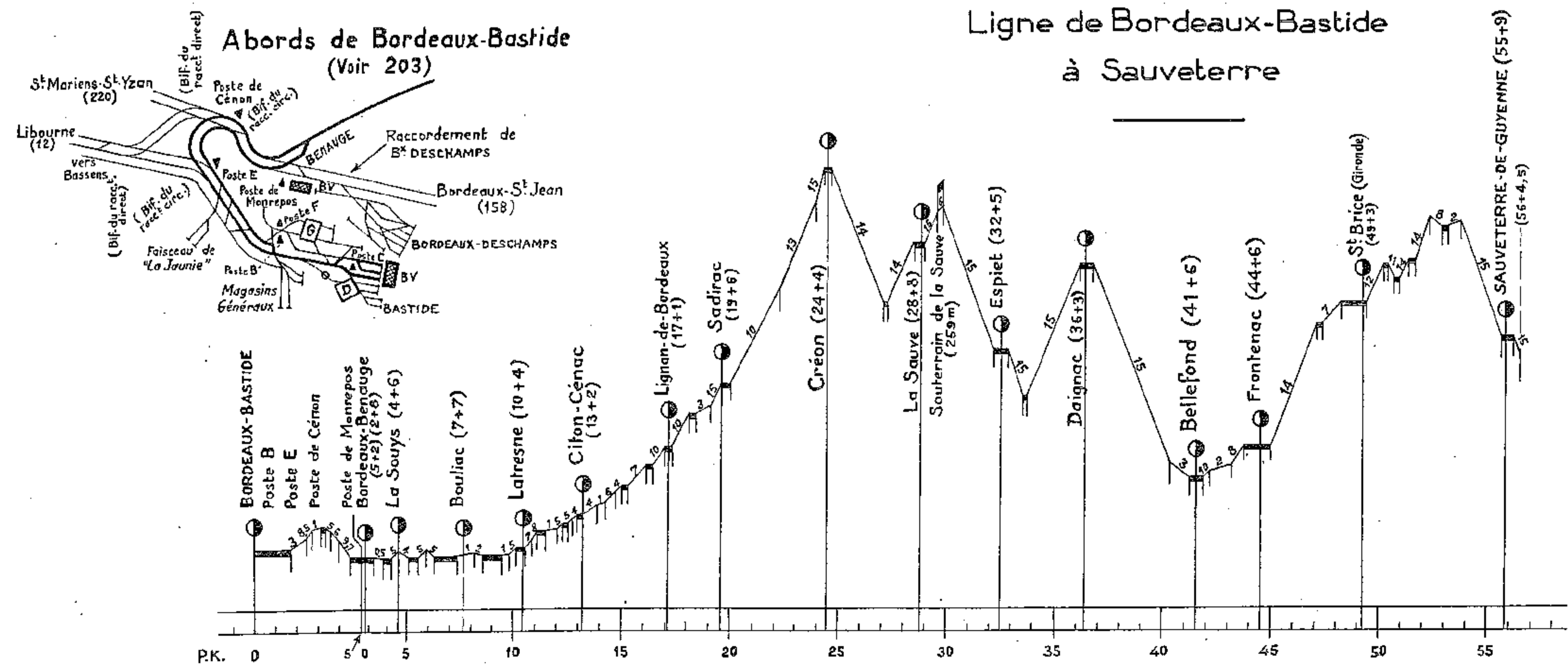
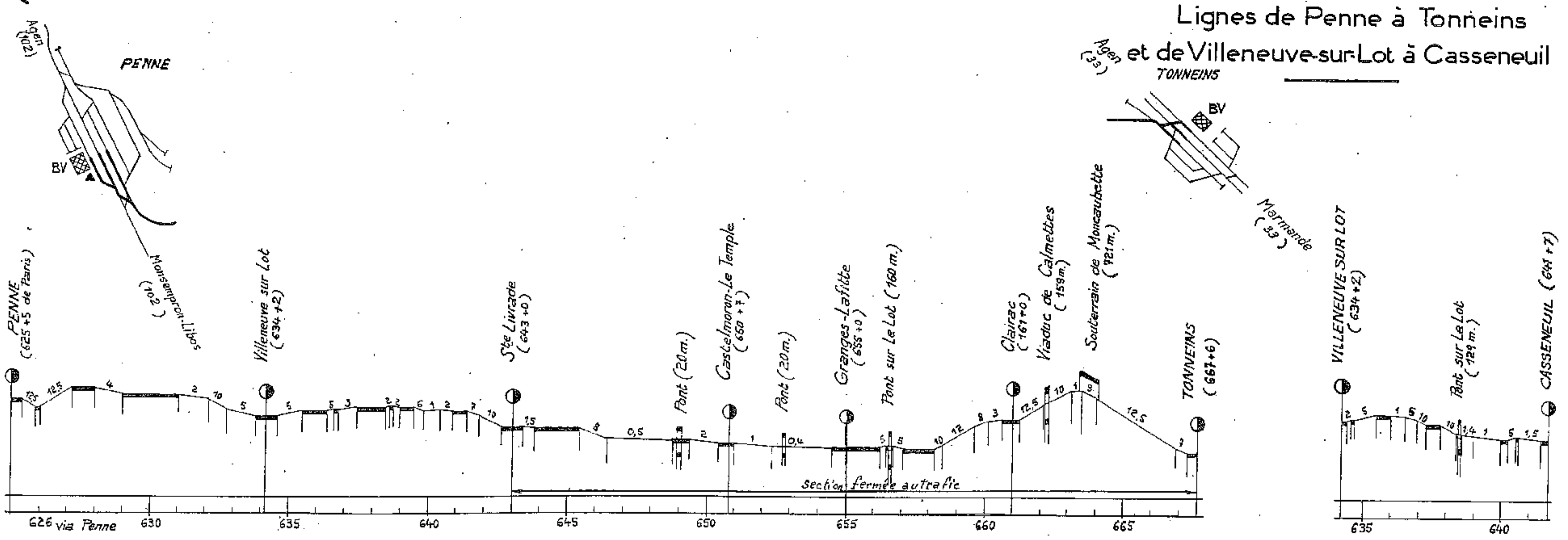

Abords de S^t Florent

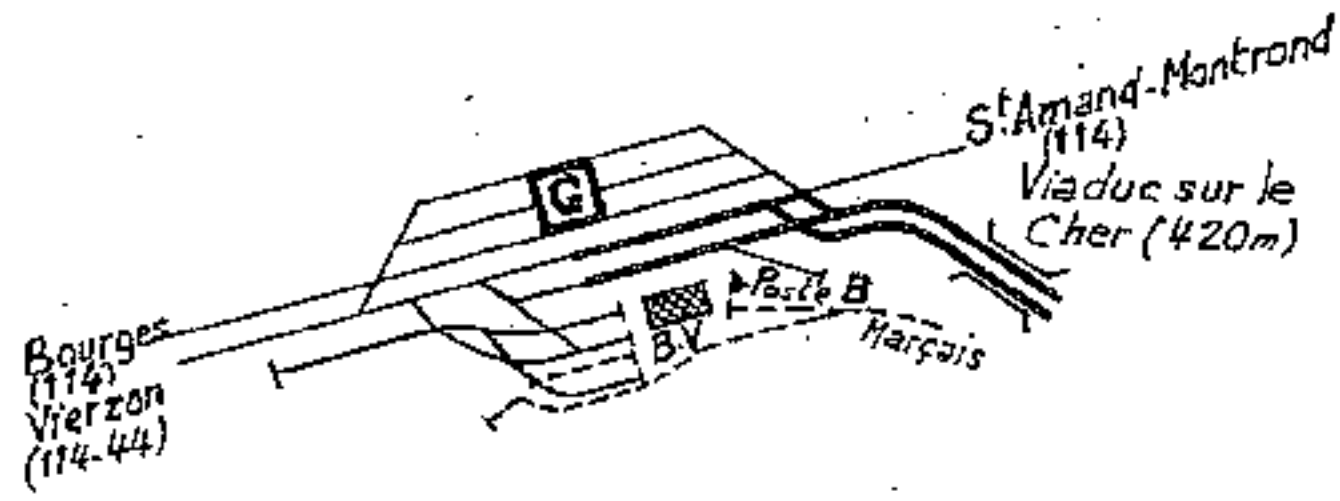

Abords d'Issoudun

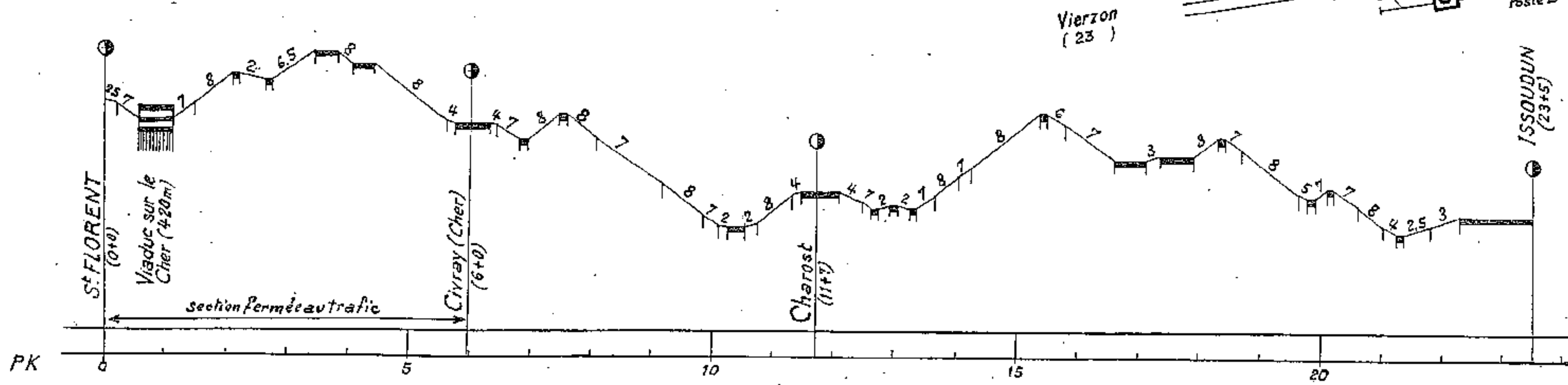
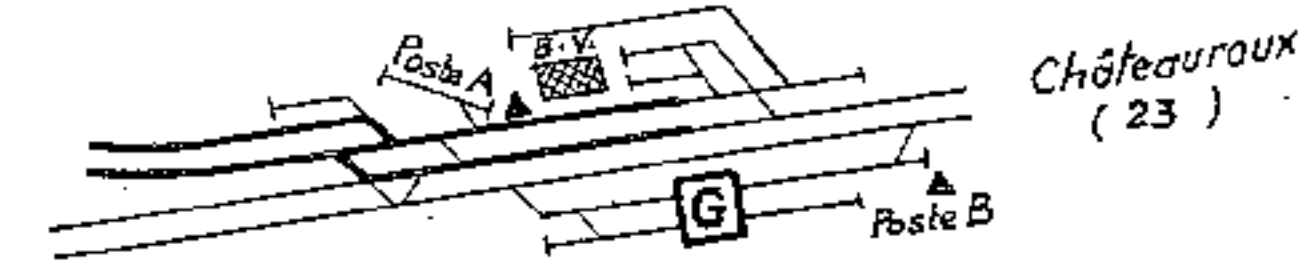

Abords de MONSEMPRON-LIBOS

Le Buisson (101)

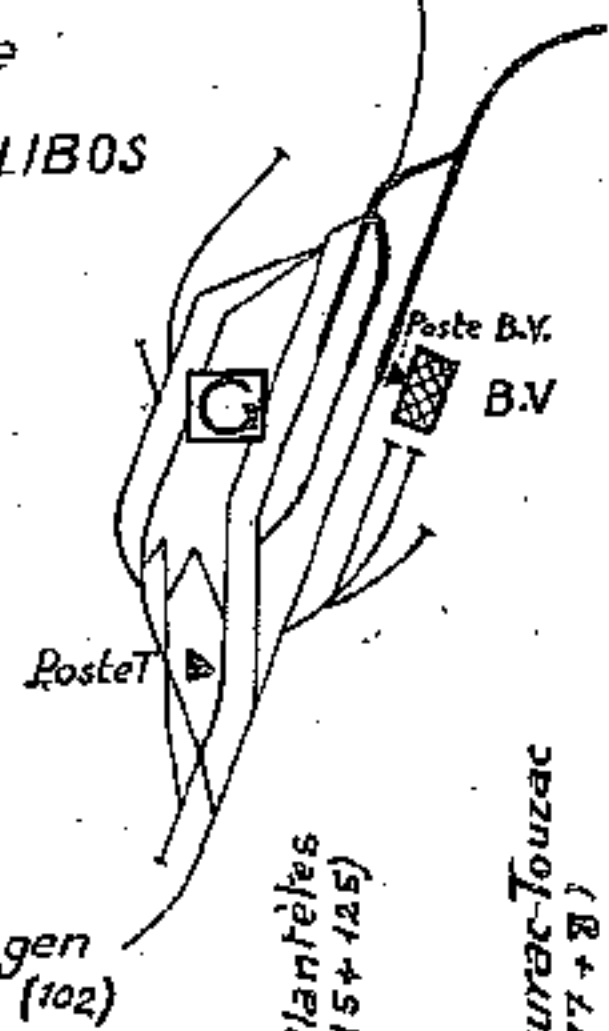

Abords de CAHORS

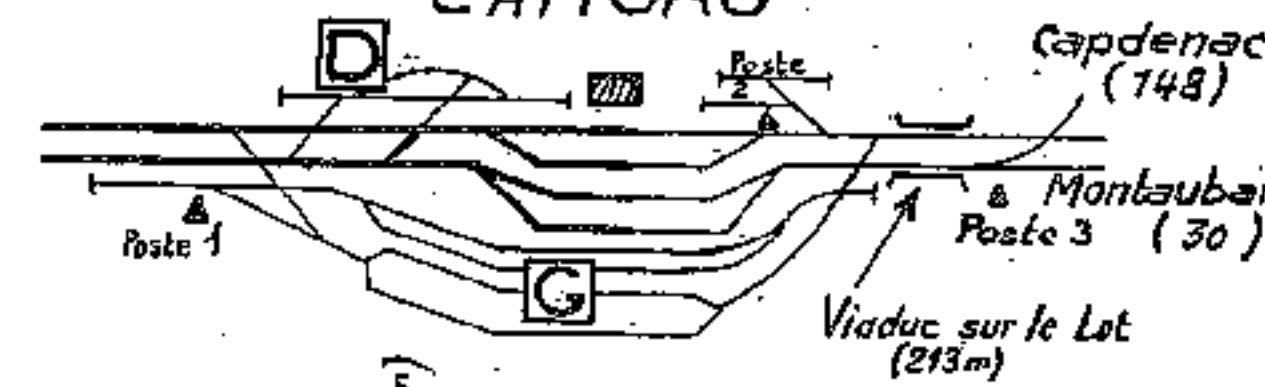

Ligne de Monsempron-Libos à Cahors

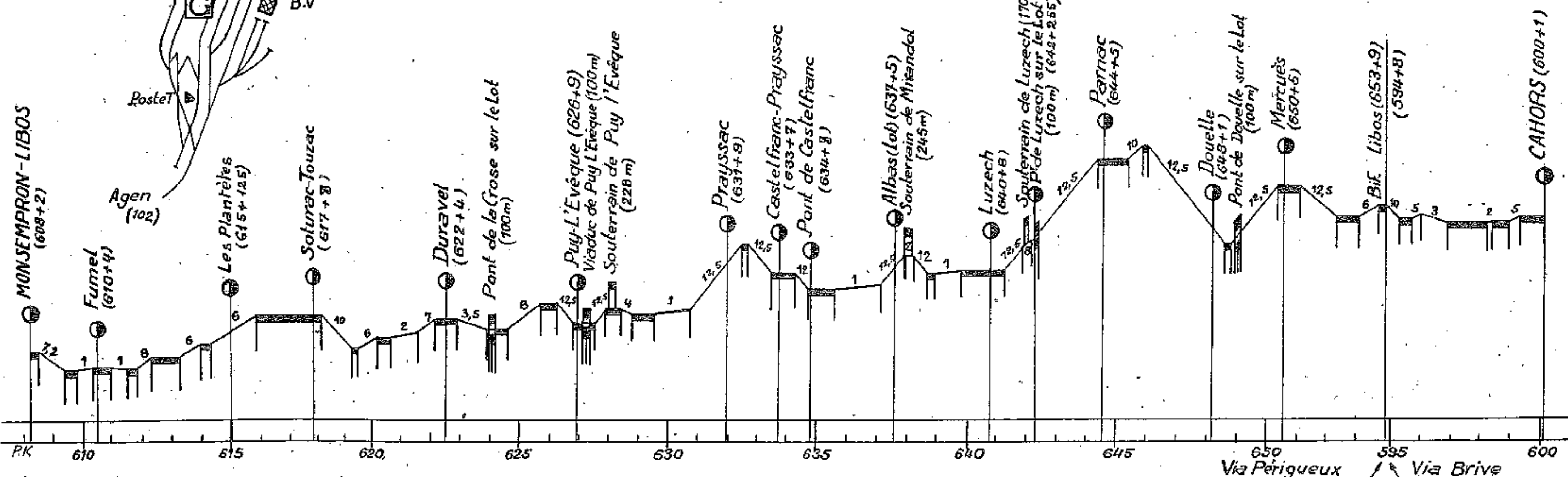

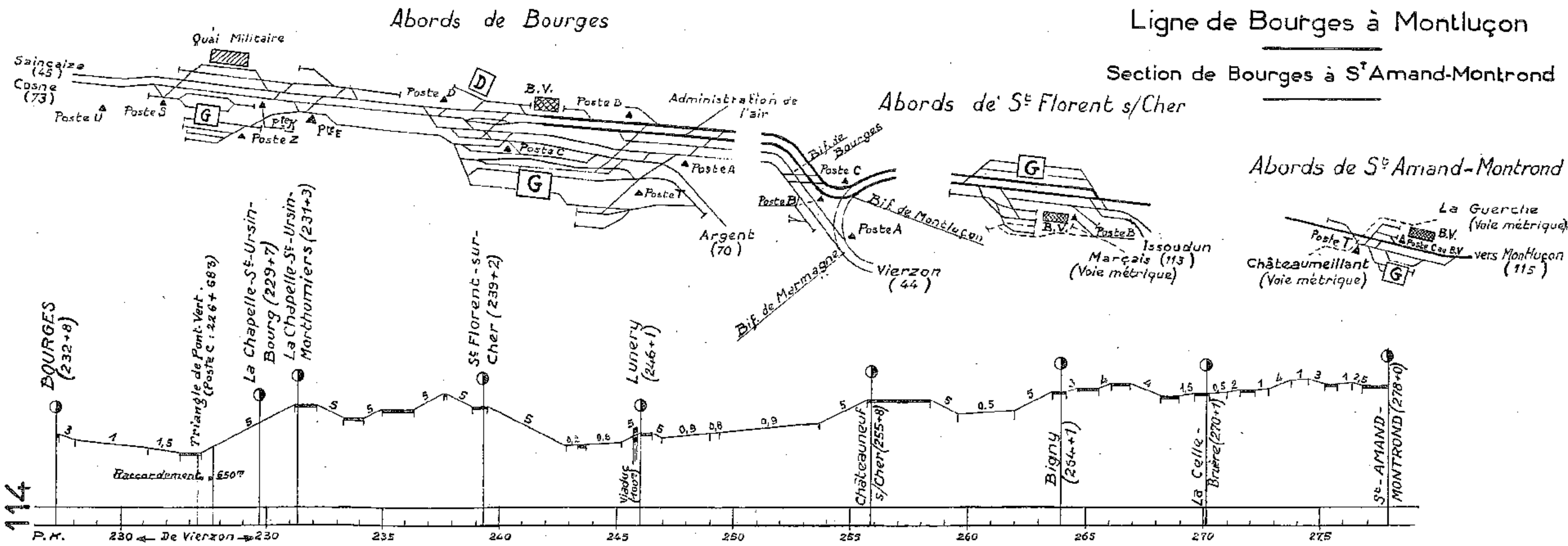
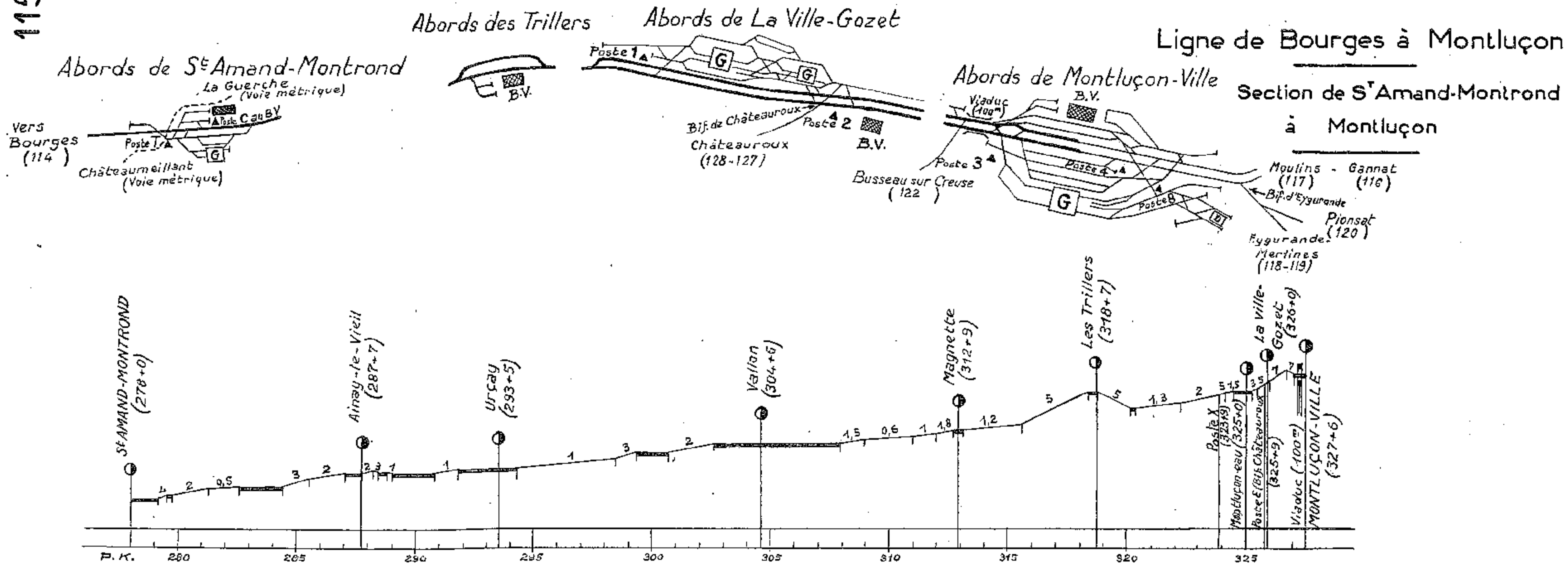

Abords de Moulins (voir

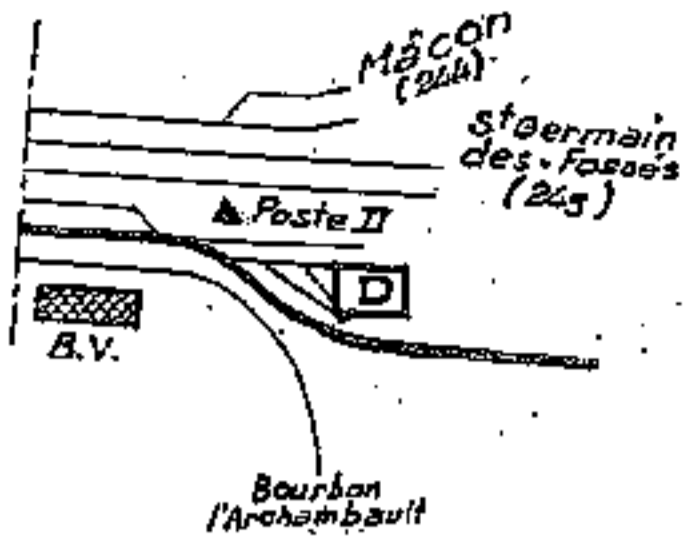

Abords de Doyet-la-Preste

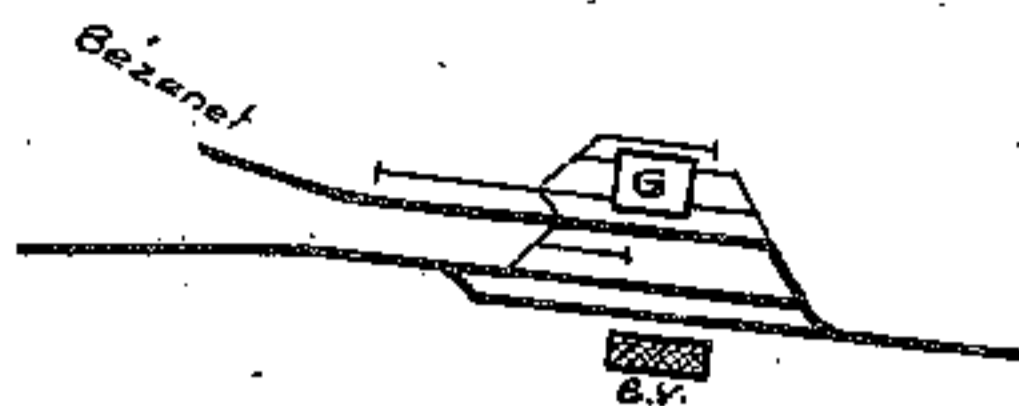

Lignes de Moulins à Commentry et de Doyet-la-Preste à Bézenet

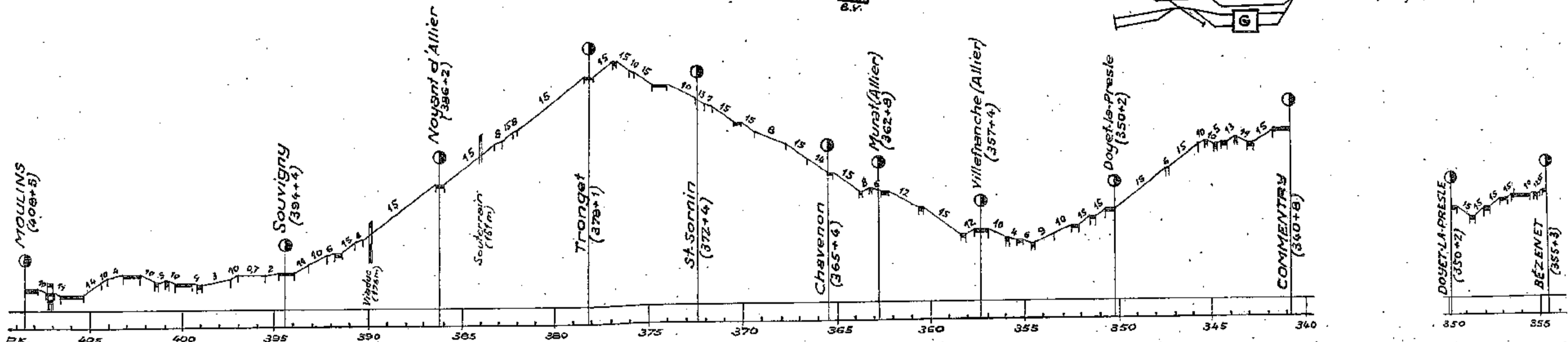
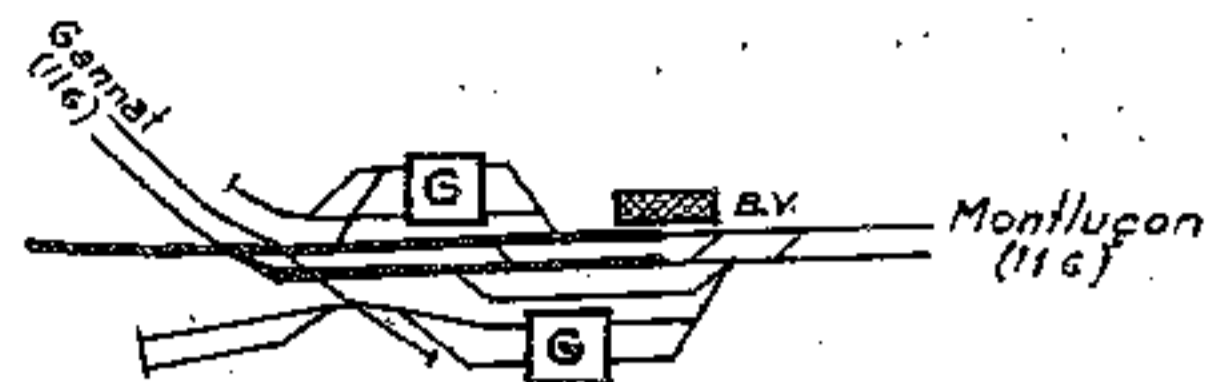

Abords de Gannat

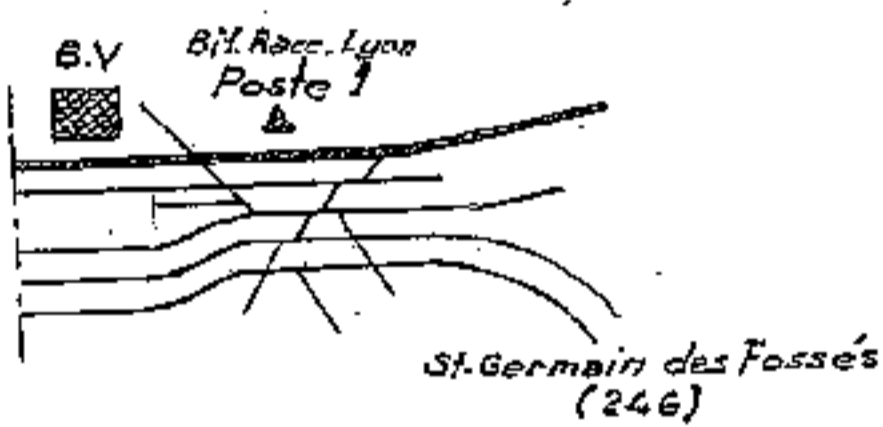

Abords de Lapeyrouse



Abords de Commentry

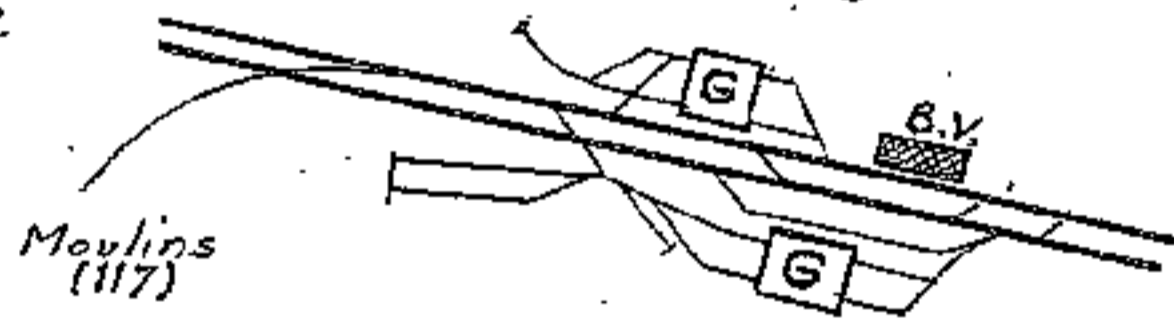

Ligne de Gannat à Montluçon

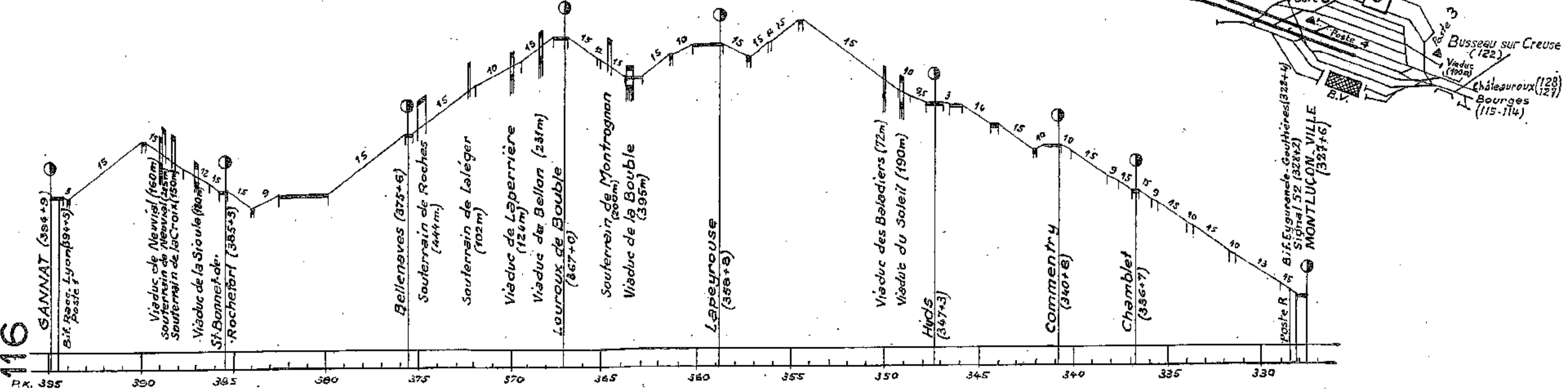
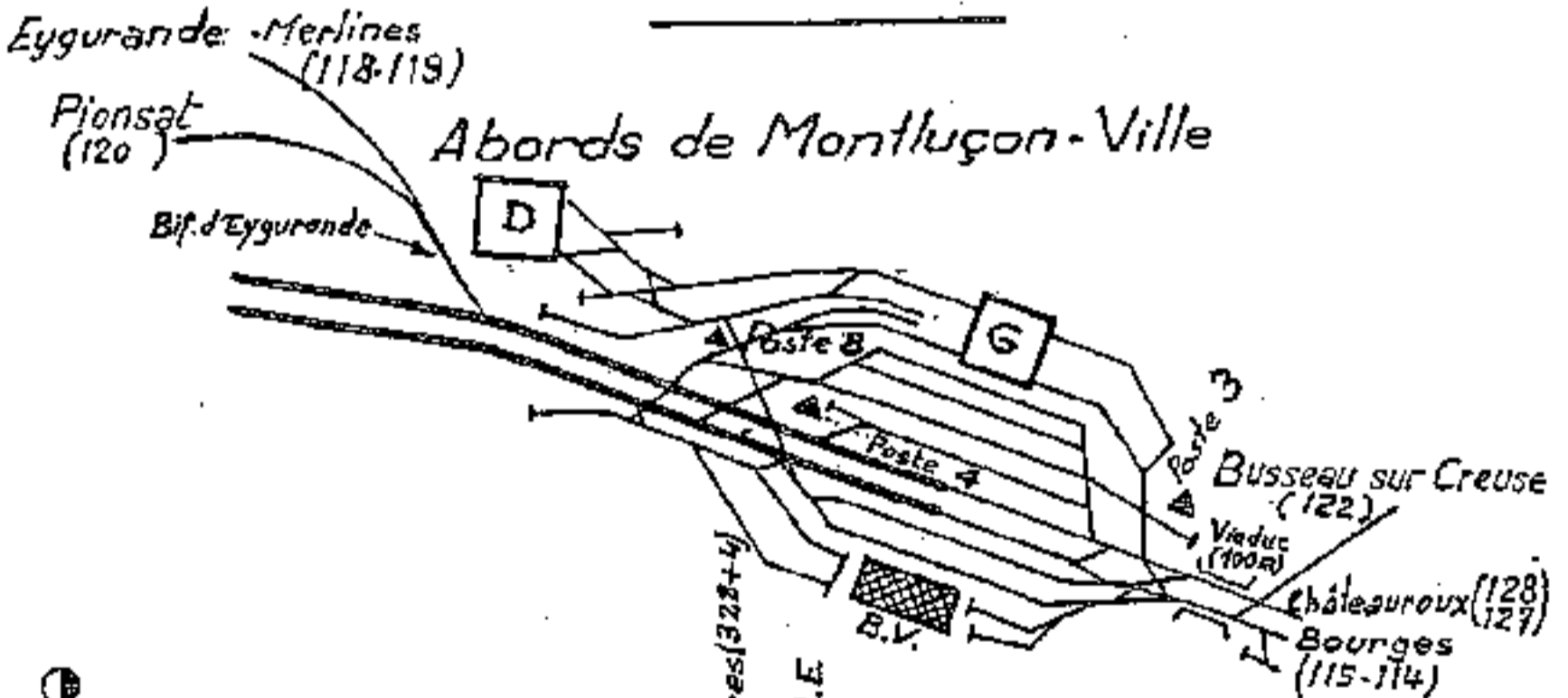

Abords d'Eygurande-Merlines

Ligne de Montluçon à Eygurande

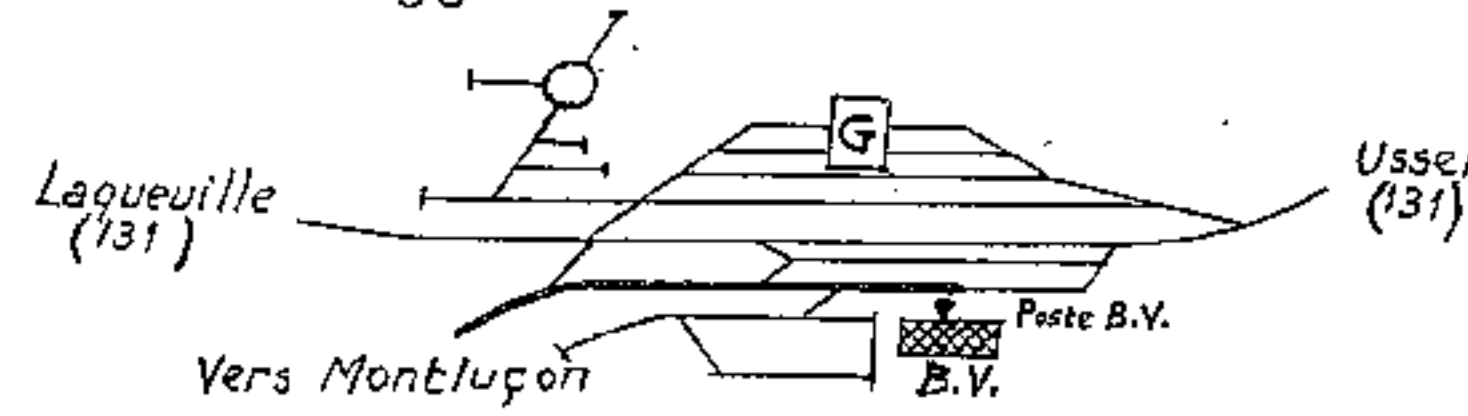

Section d'Auzances à Eygurande

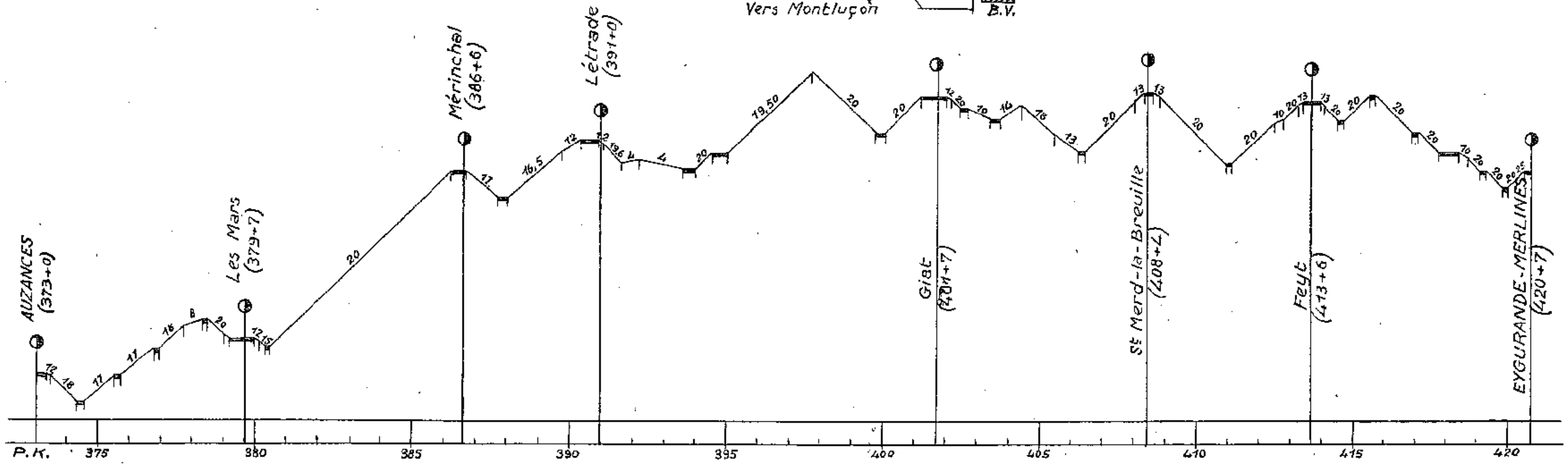

Abords de Montluçon-ville

Ligne de Montluçon à Eygurande

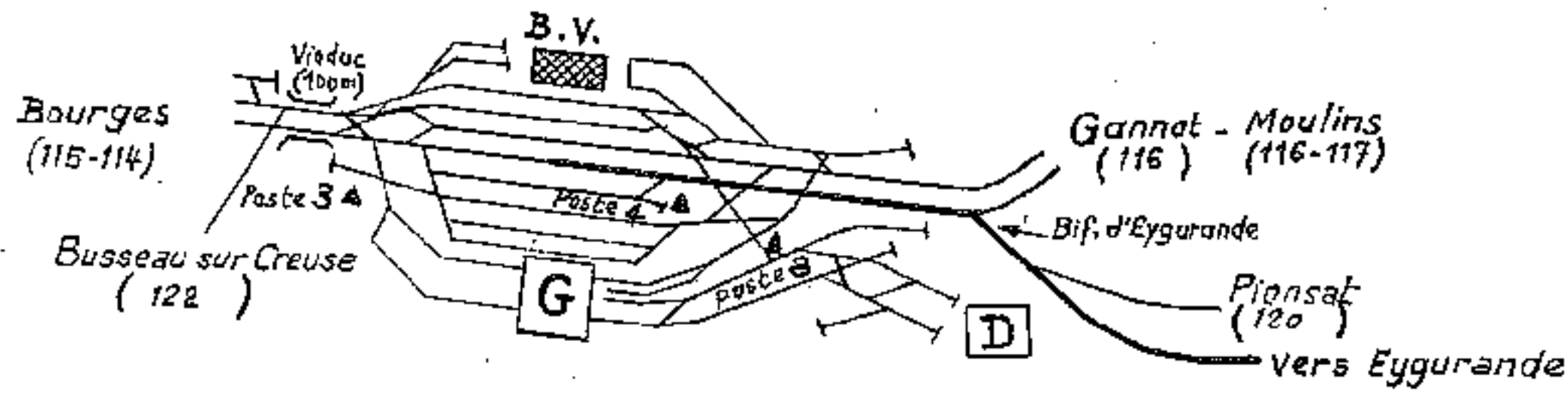

Section de Montluçon à Auzances

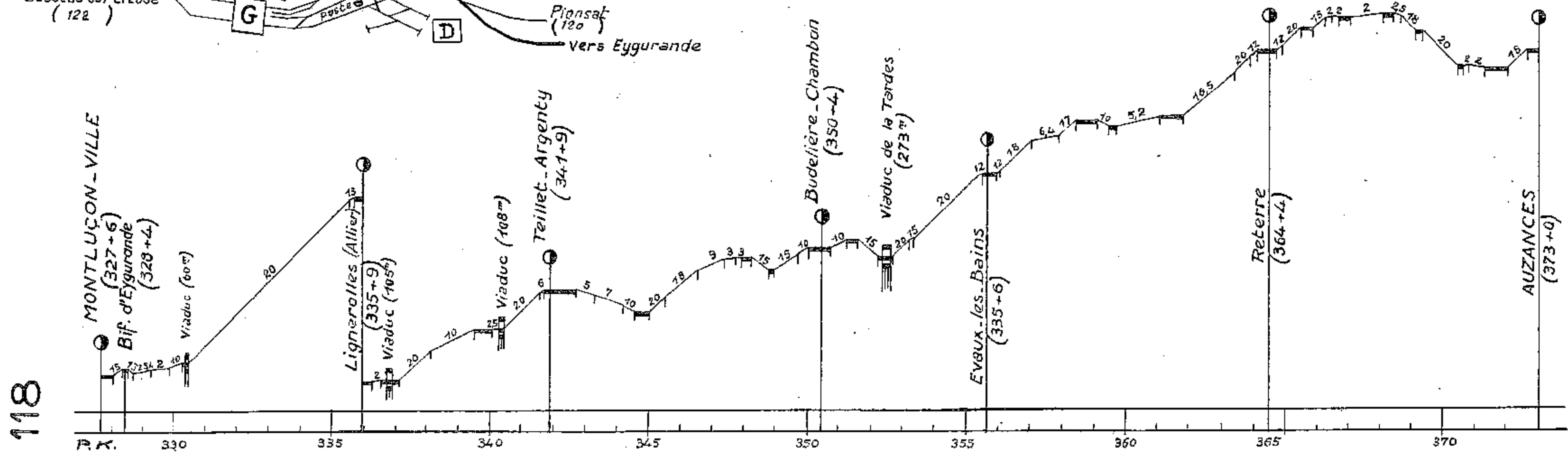

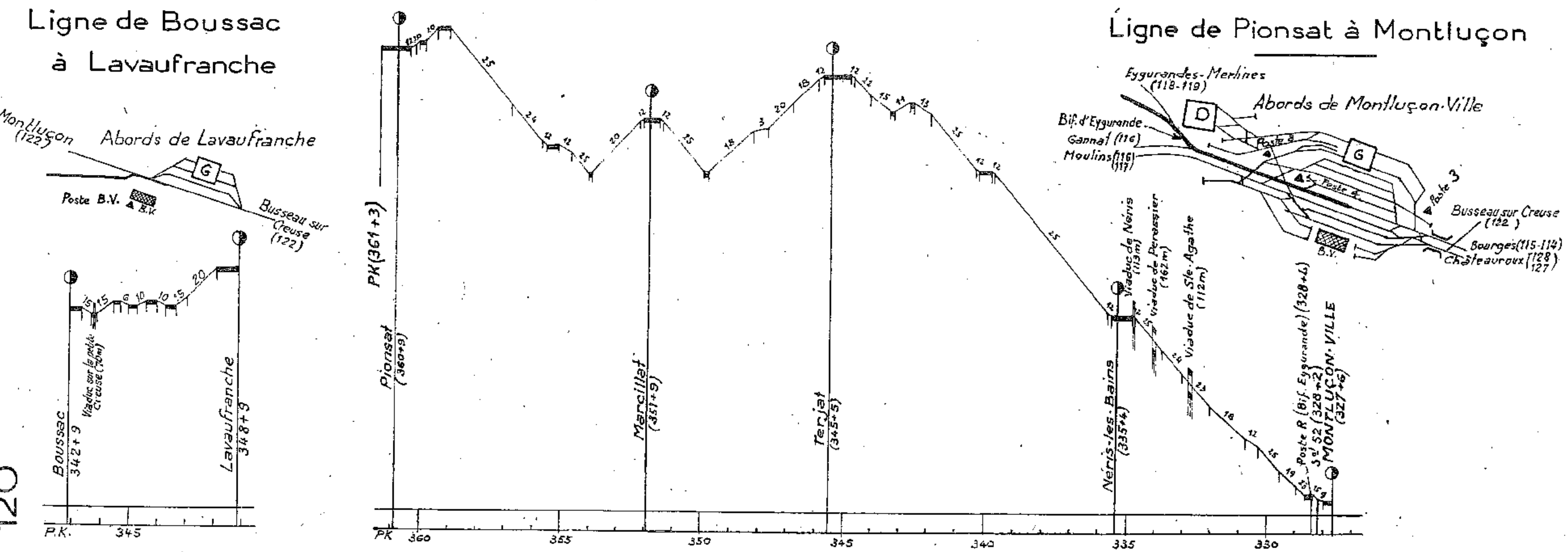
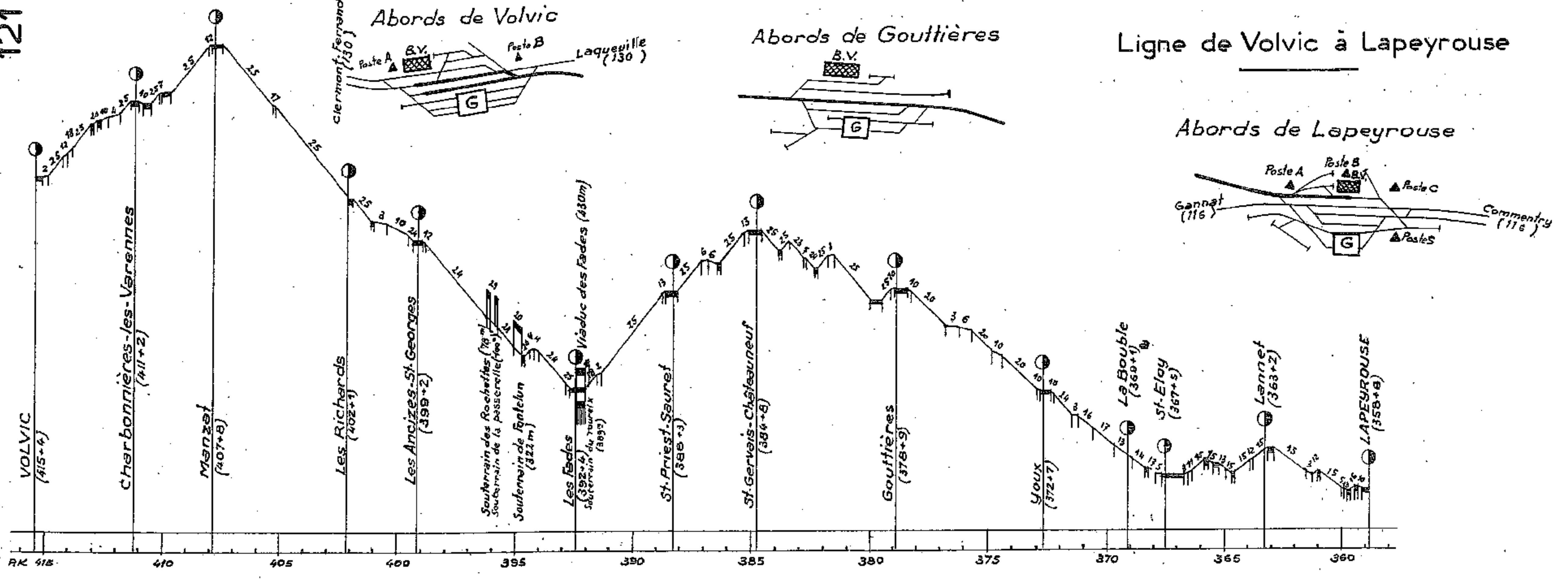

Ligne de Montluçon à S^tSulpice-Laurière

Section de Busseau-sur-Creuse à S^tSulpice-Laurière

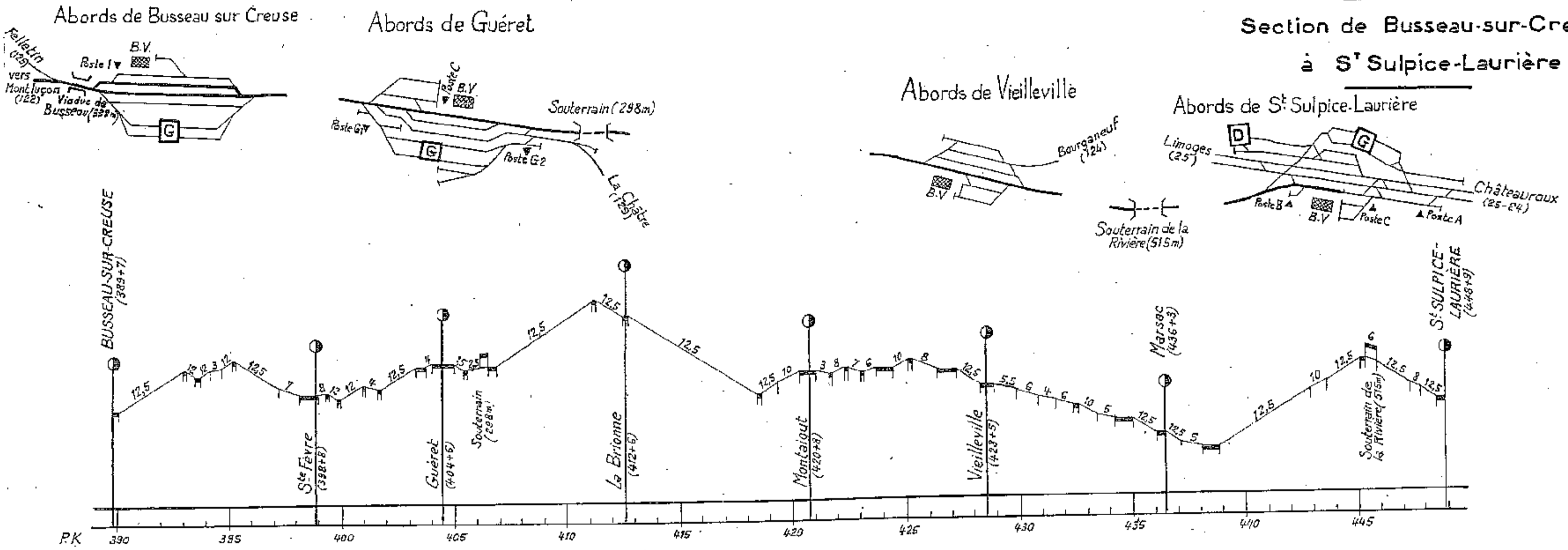

Abords de Montluçon

Abords de Lavaufranche

Ligne de Montluçon à S^tSulpice-Laurière

Section de Montluçon à Busseau-sur-Creuse

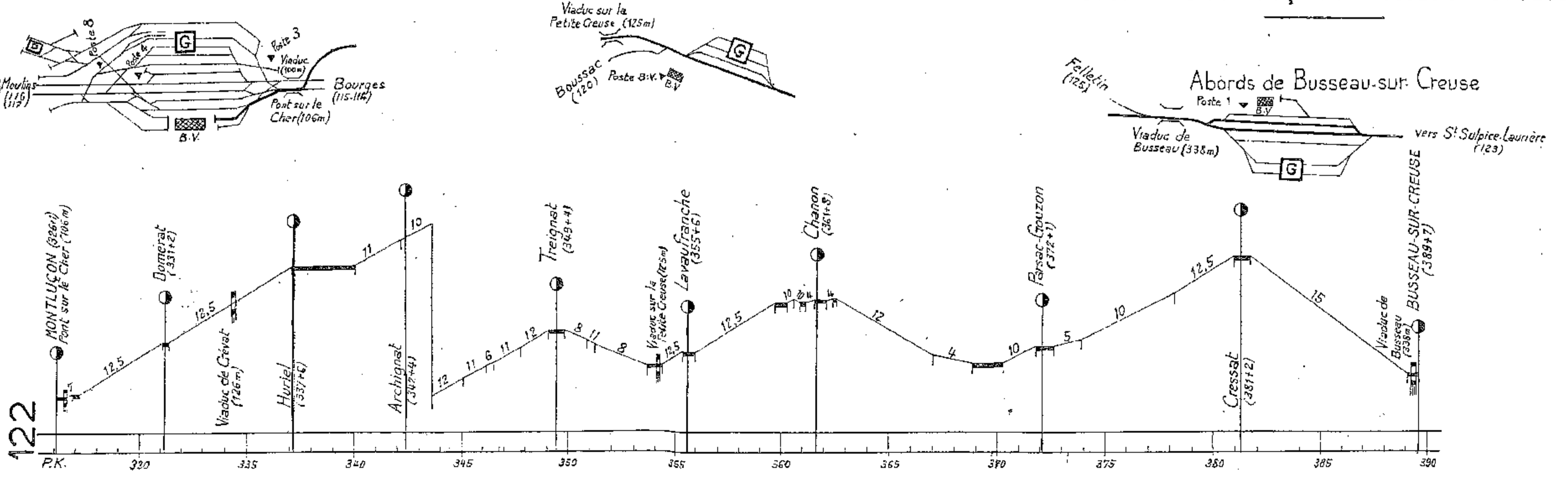

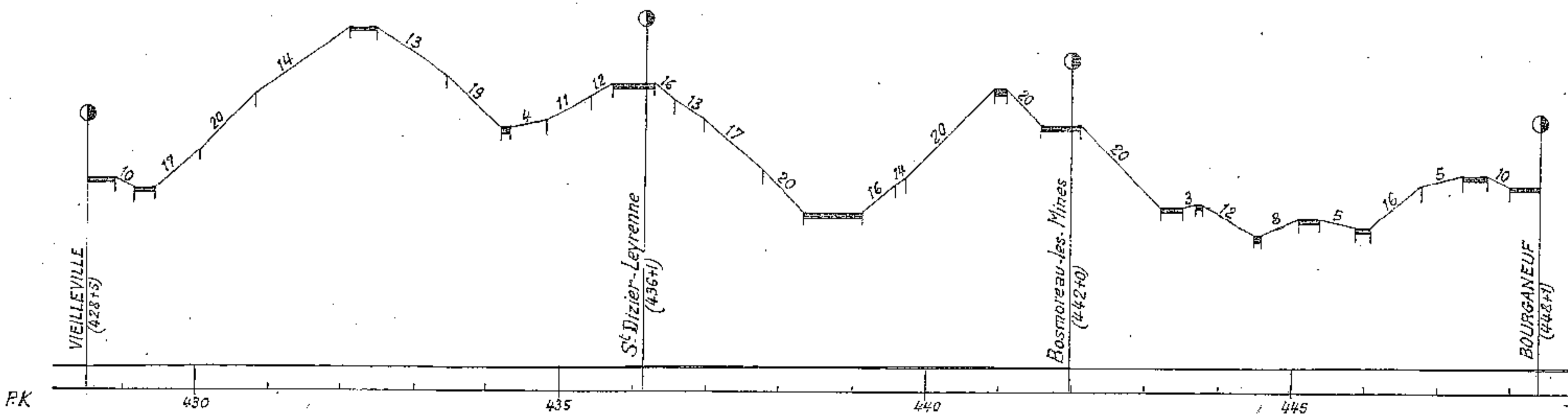
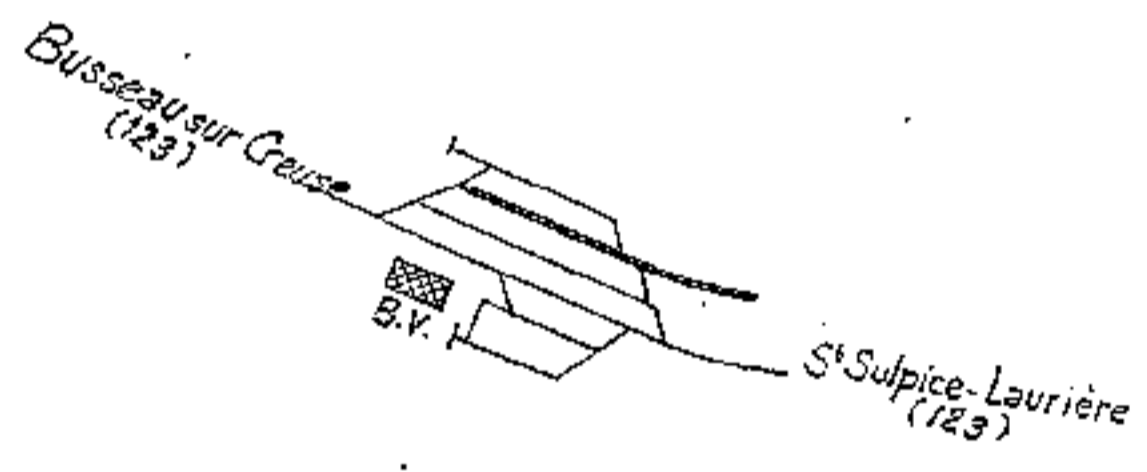
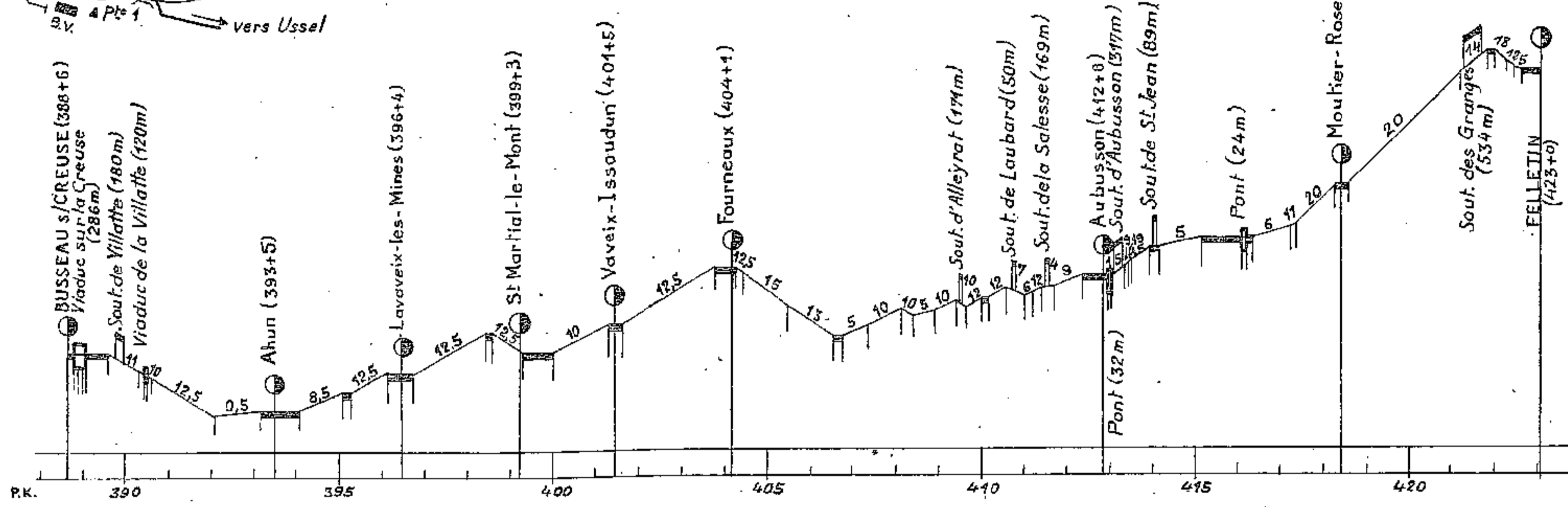
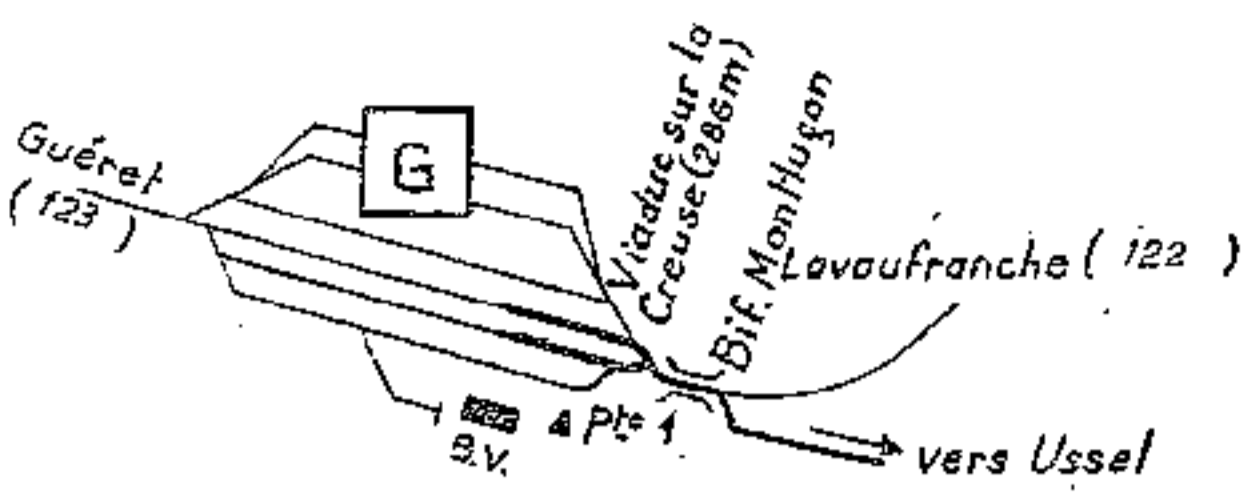

Ligne de Châteauroux à Montluçon

Section de Châteauroux à Champillet-Urciers

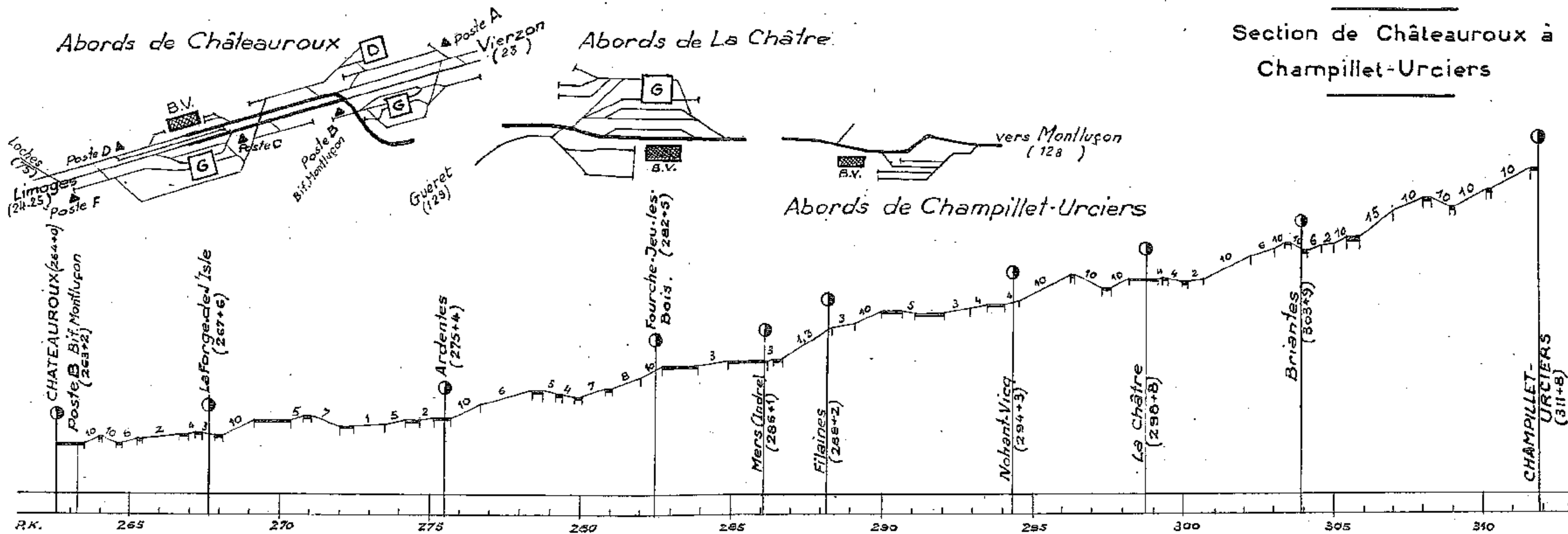

Ligne de Busseau-sur-Creuse à Ussel

Section de Felletin à Ussel

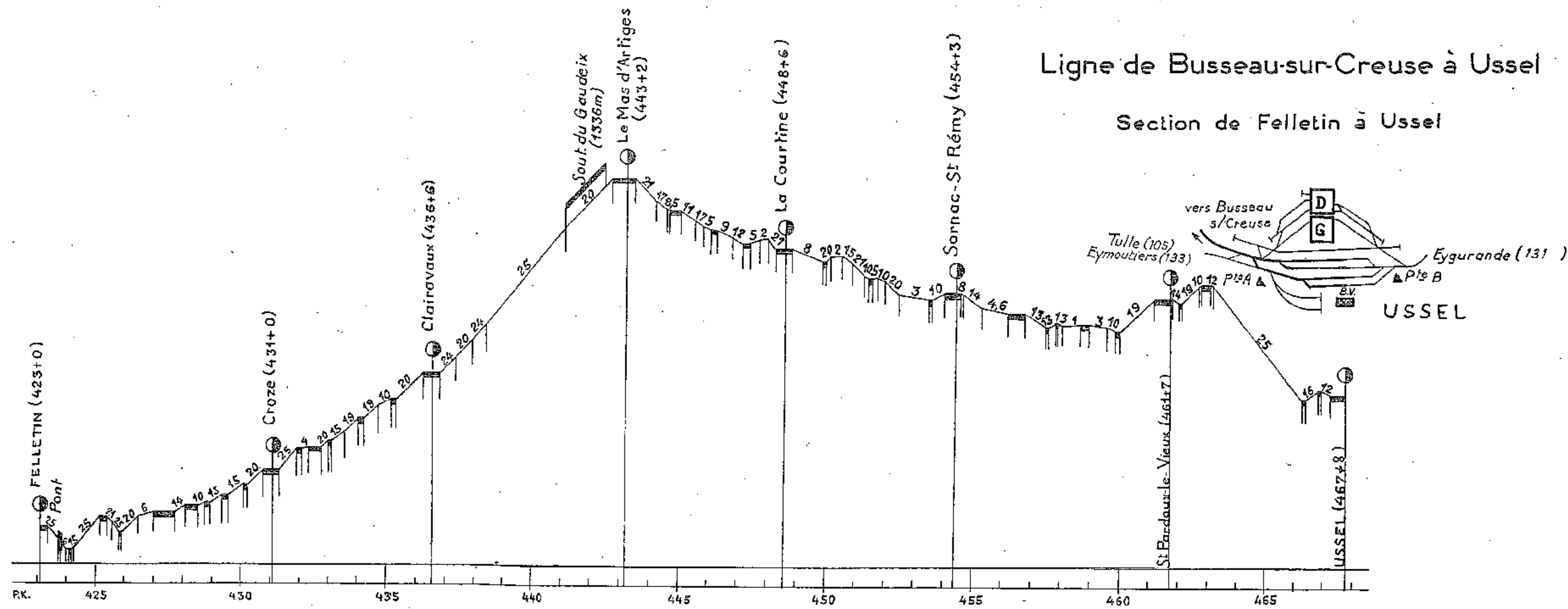

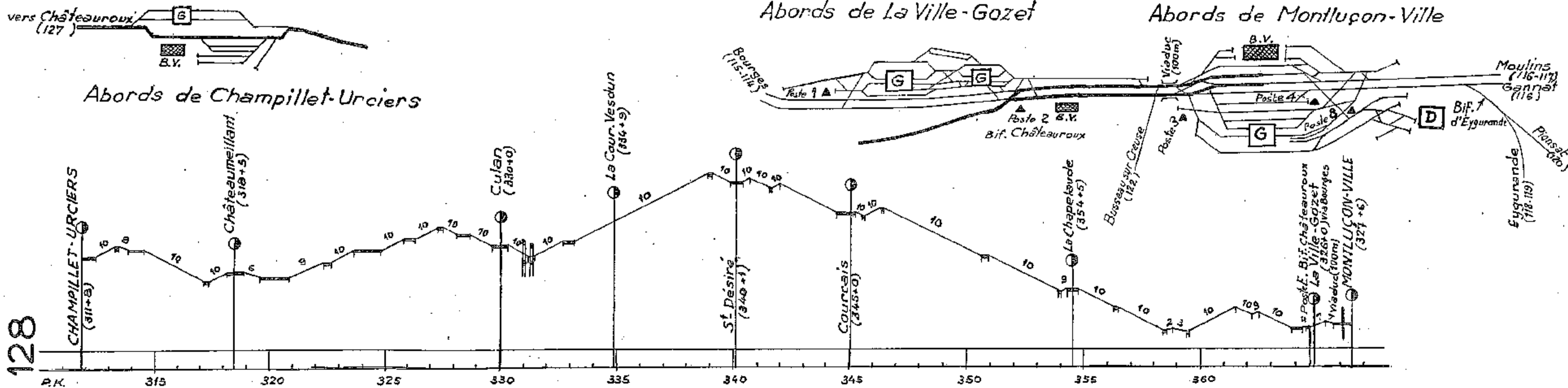
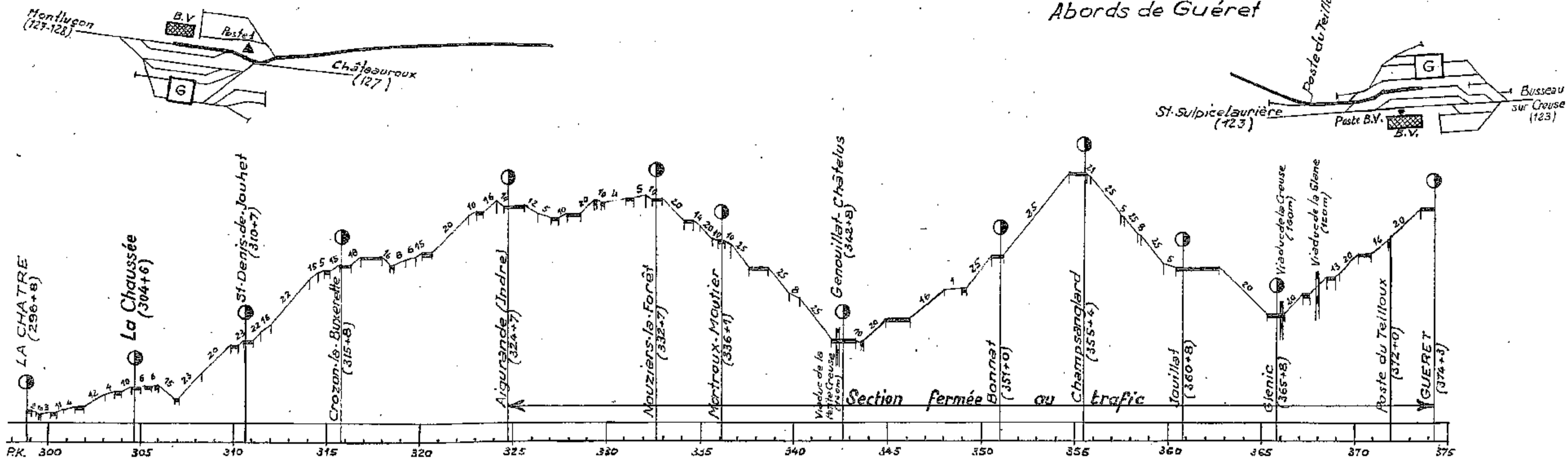

Ligne de Clermont-Ferrand à Ussel

Abords de Laqueuille

Abords d'Eygurande-Merlines

Section de Laqueuille à Ussel

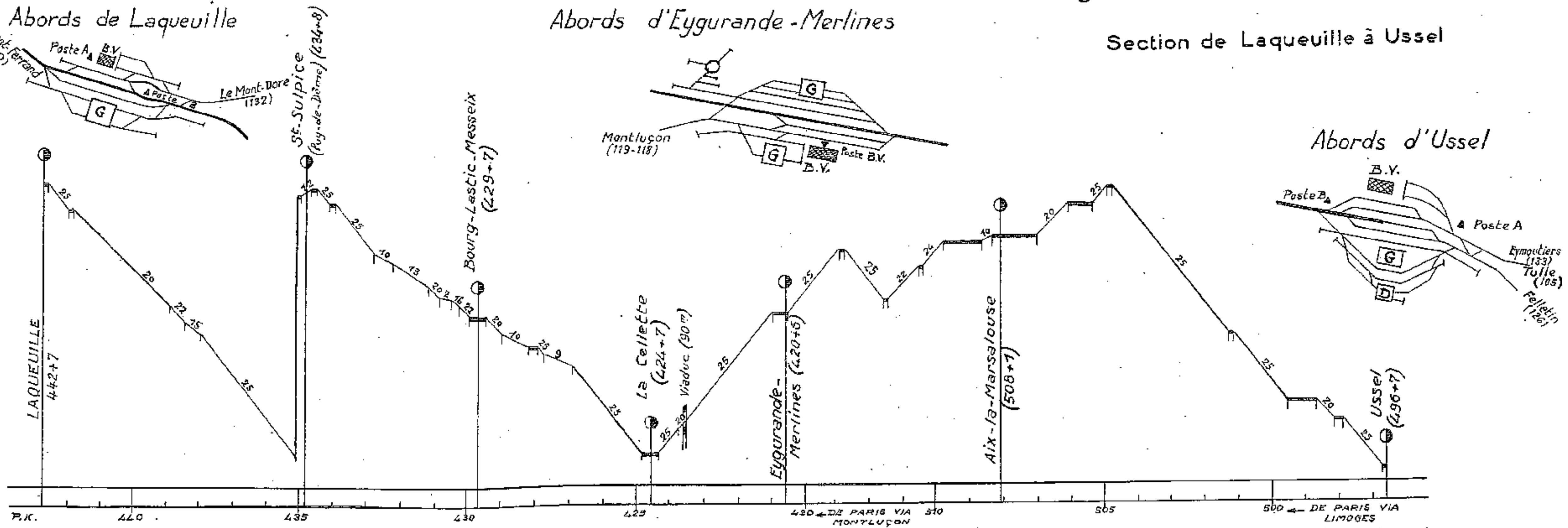

Abords de Clermont-Ferrand

Abords de Volvic

Ligne de Clermont-Ferrand à Ussel

Section de Clermont-Ferrand à Laqueuille

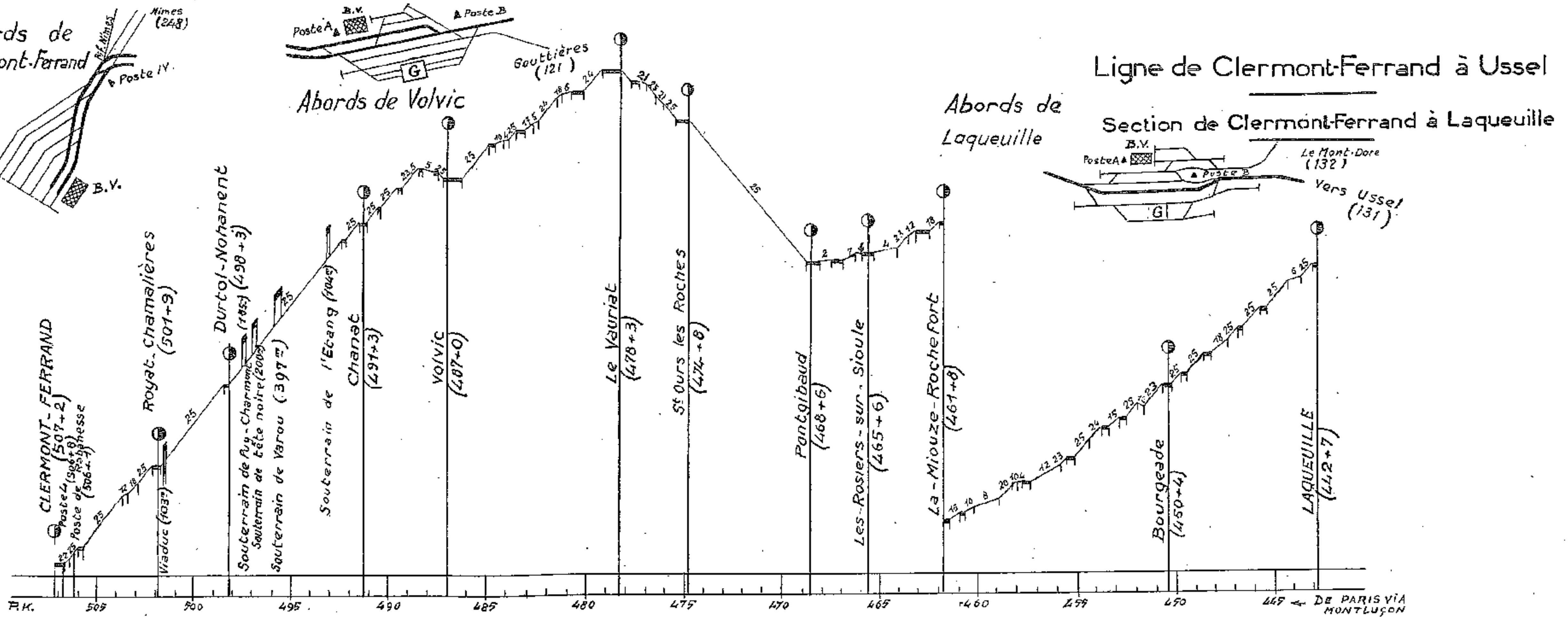

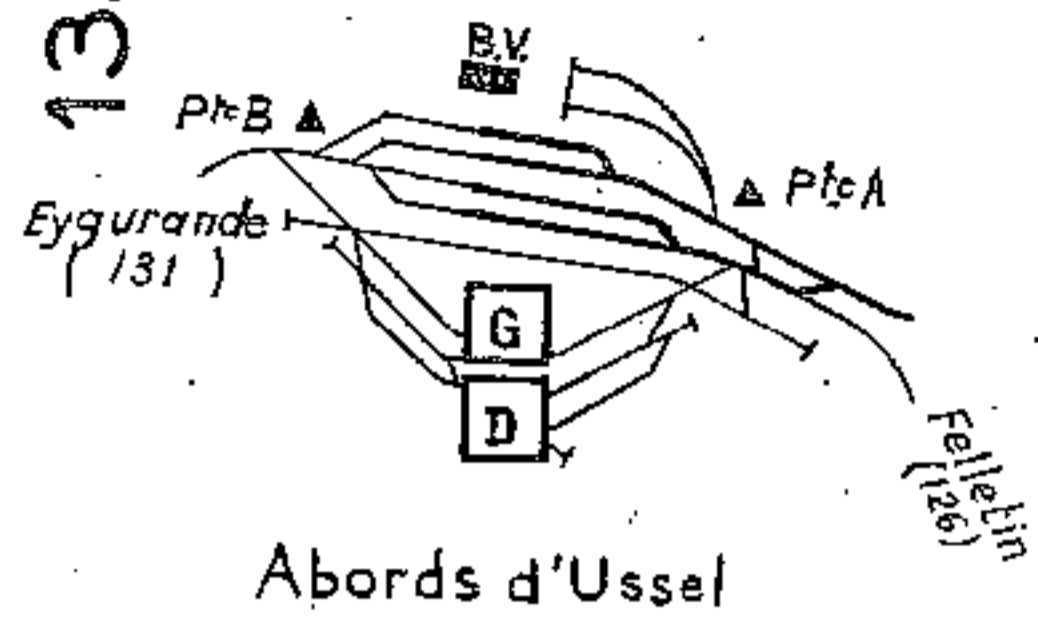

Abords de Meymac

Ligne d'Ussel à Limoges

Section d'Ussel à Eymoutiers

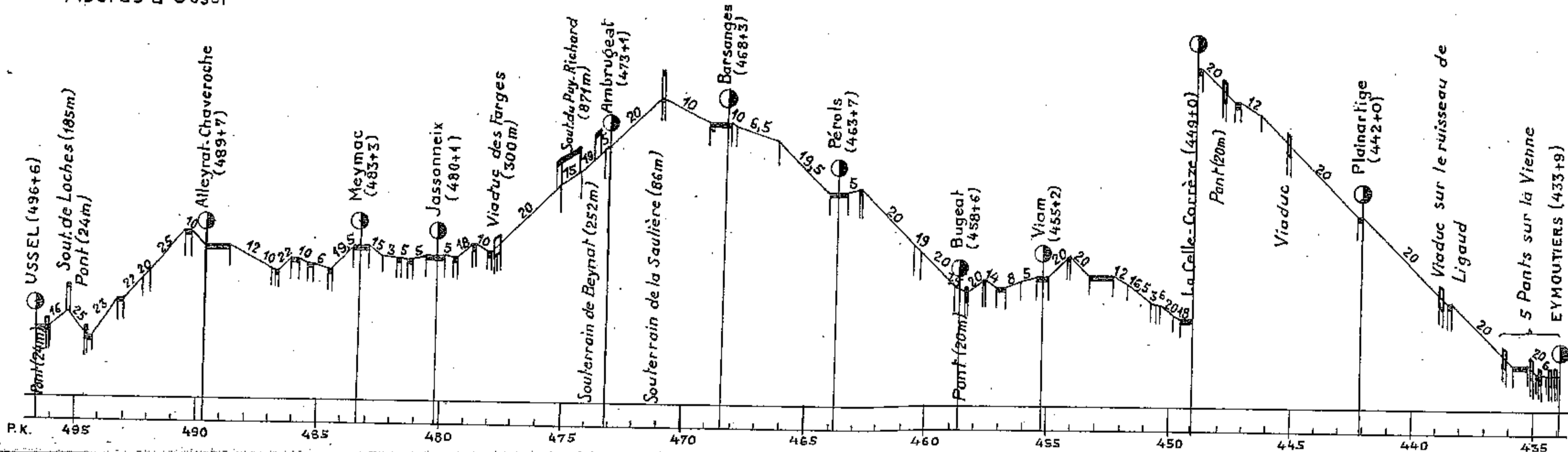

Abords de Laqueuille

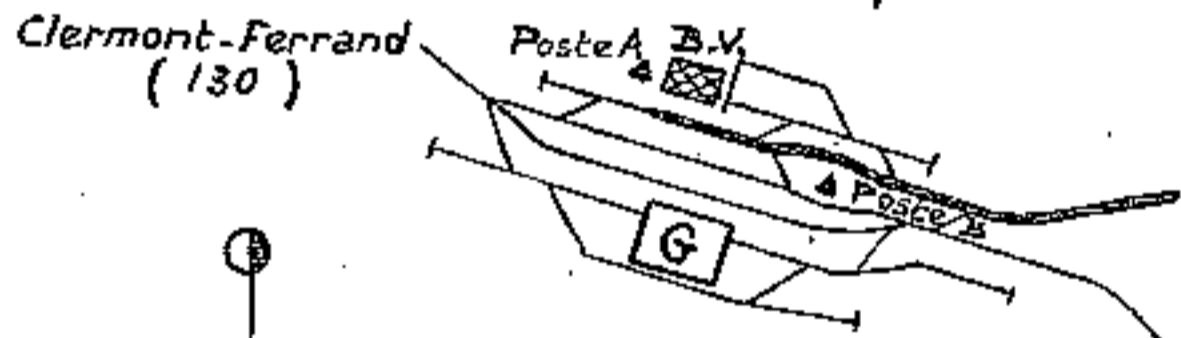

Abords du Mont-Dore

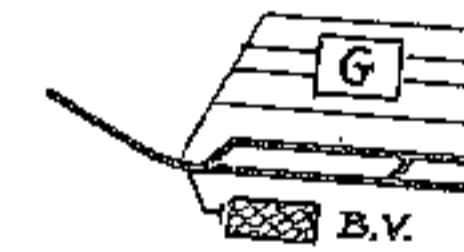

Ligne de Laqueuille au Mont-Dore

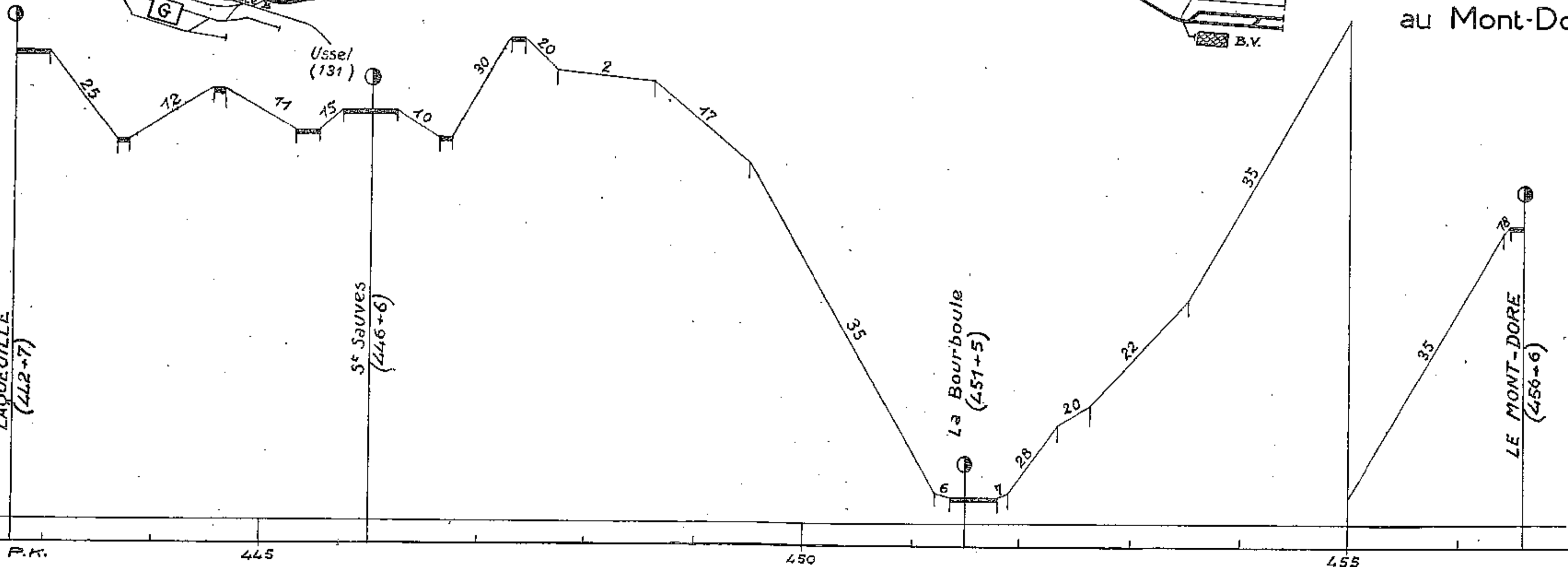

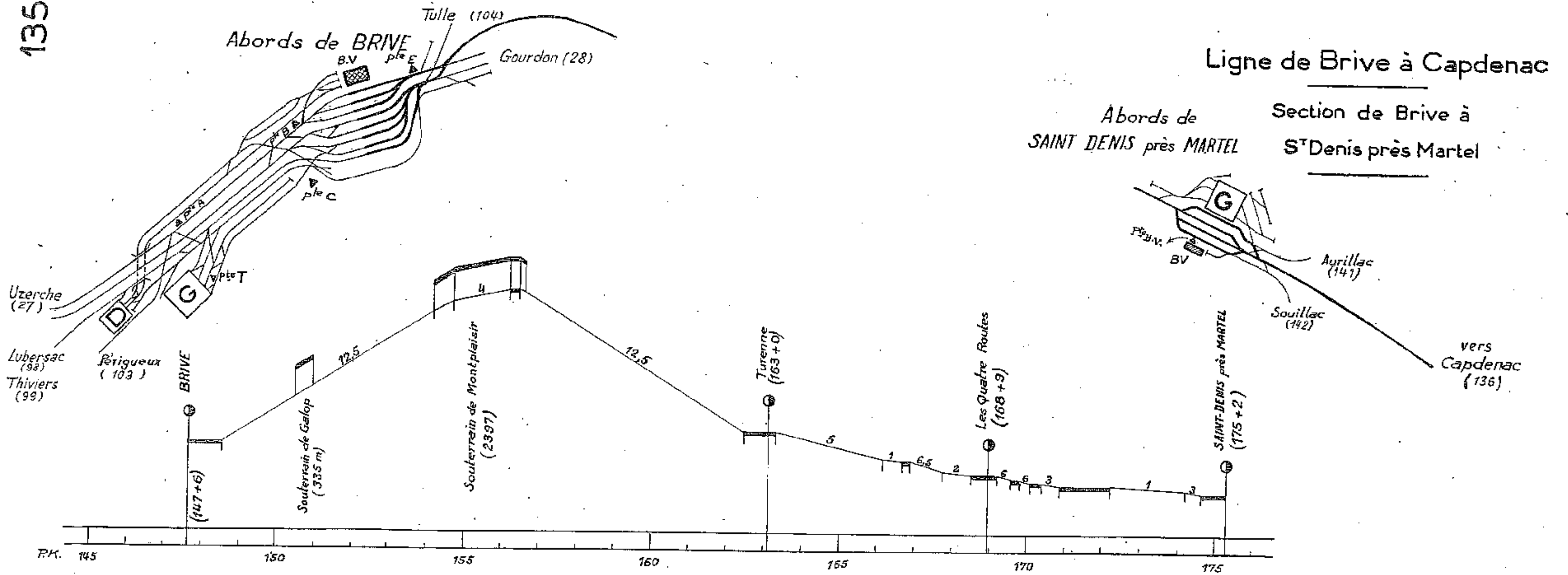

Ligne d'Ussel à Limoges

Section d'Eymoutiers à Limoges

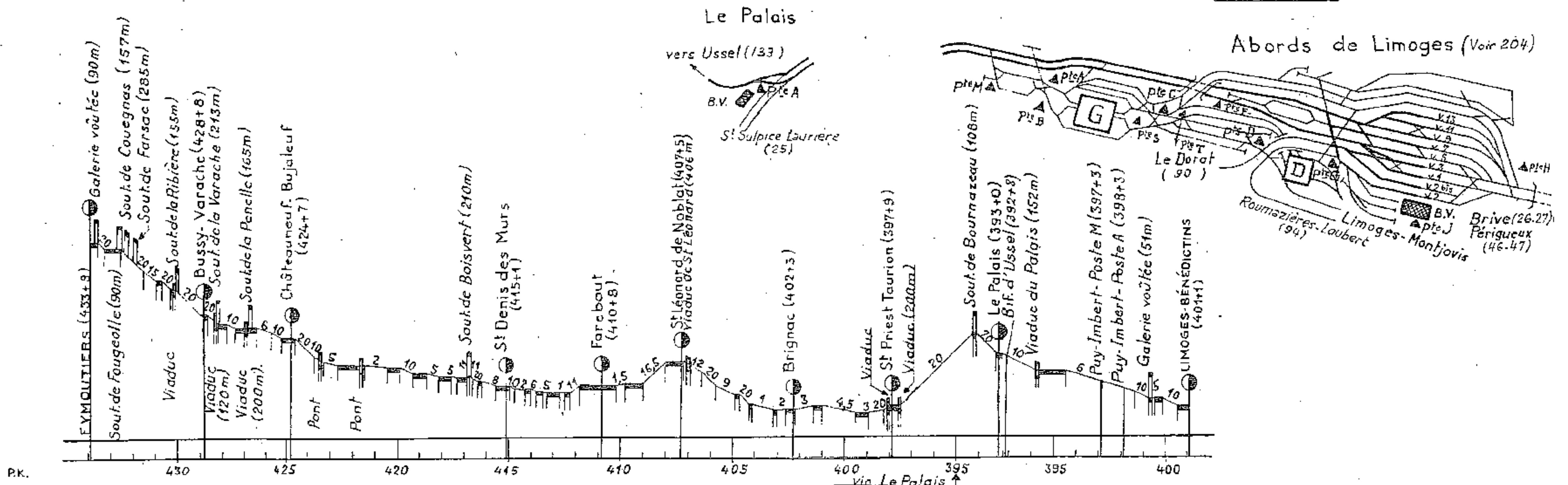

Abords de Capdenac Rodez (147)

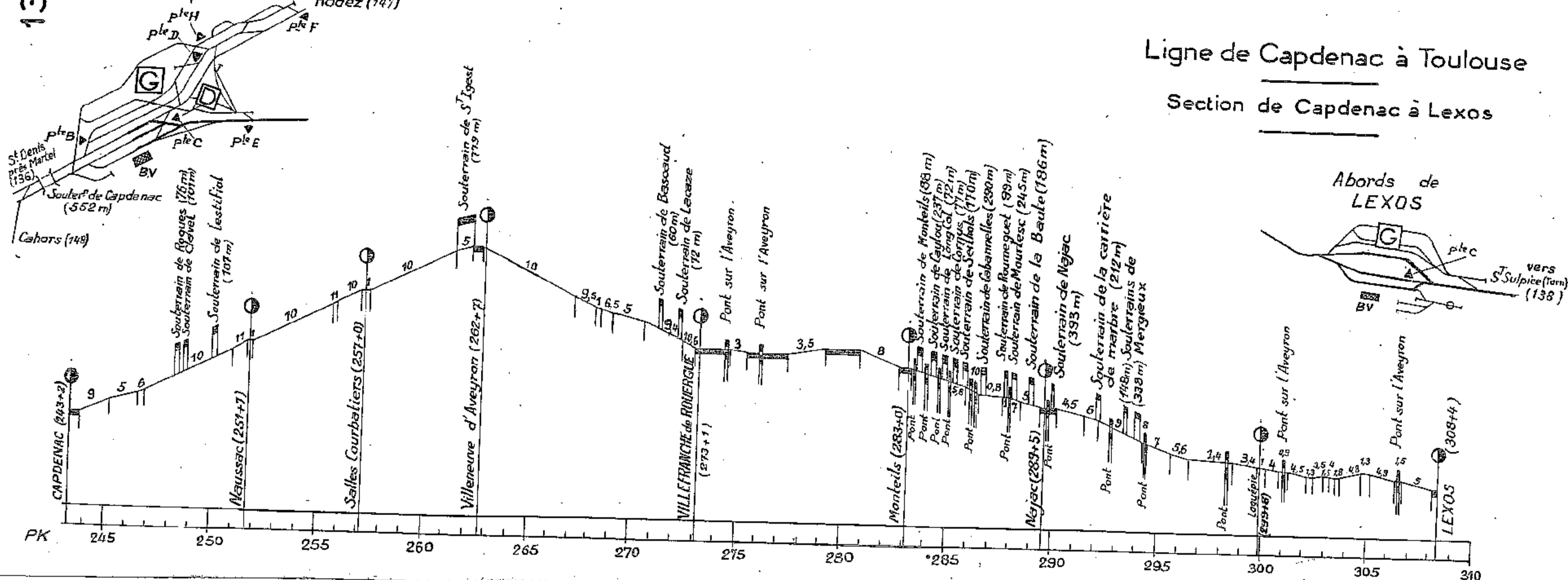

Ligne de Capdenac à Toulouse
Section de Capdenac à Lexos

Abords de SAINT DENIS près MARTEL

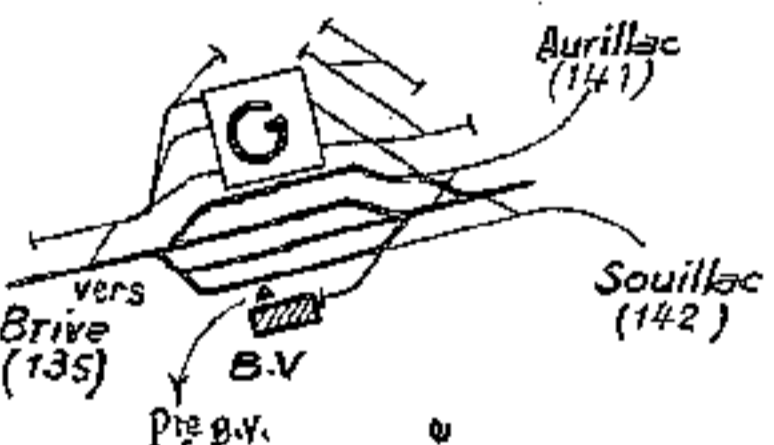

GRAMAT

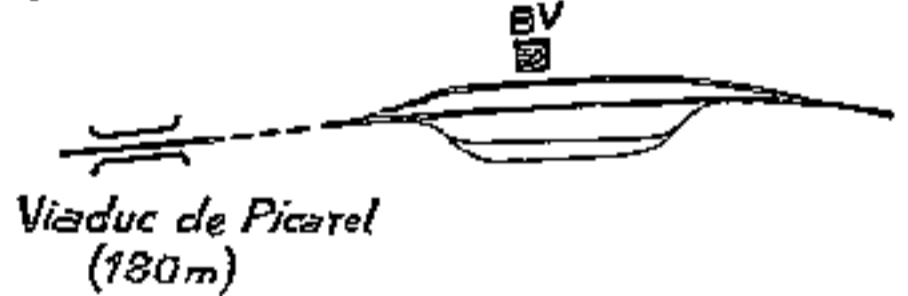

Ligne de Brive à Capdenac

Section de S^t Denis-près-Martel à Capdenac

Abords de FIGEAC

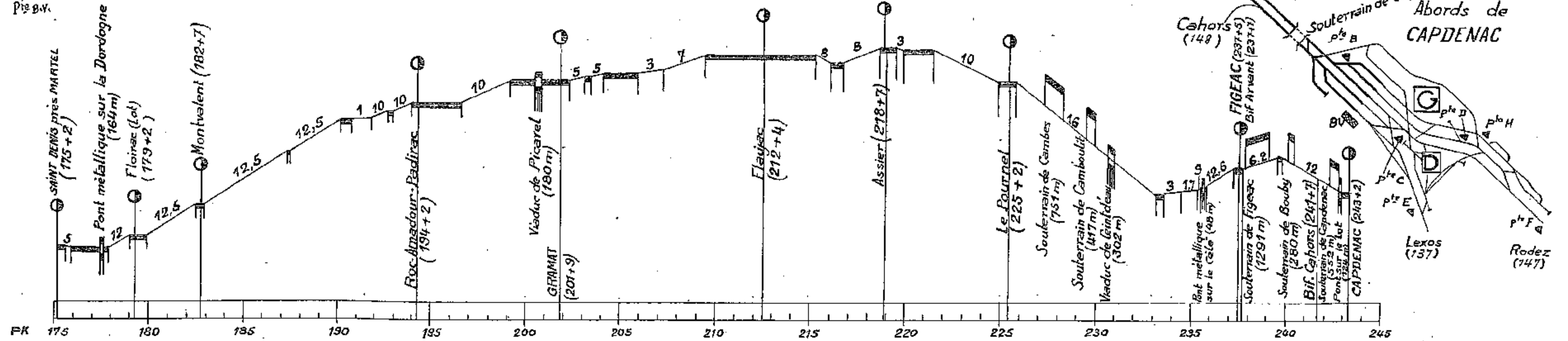
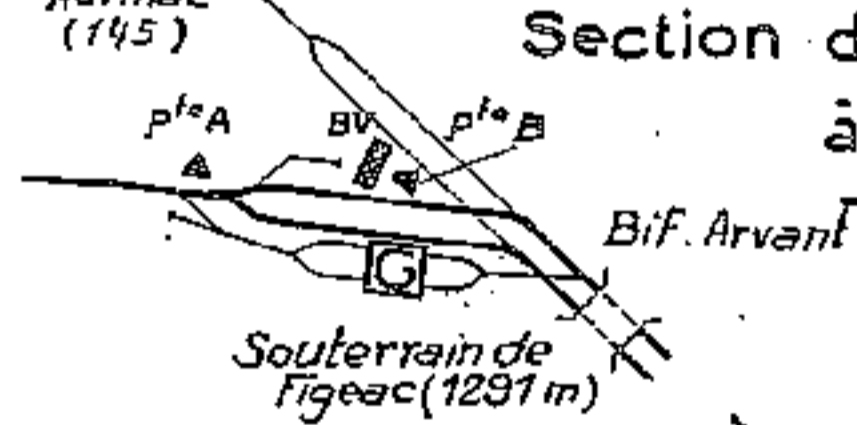

Abords de CAPDENAC

Abords de S^t SULPICE (TARN)

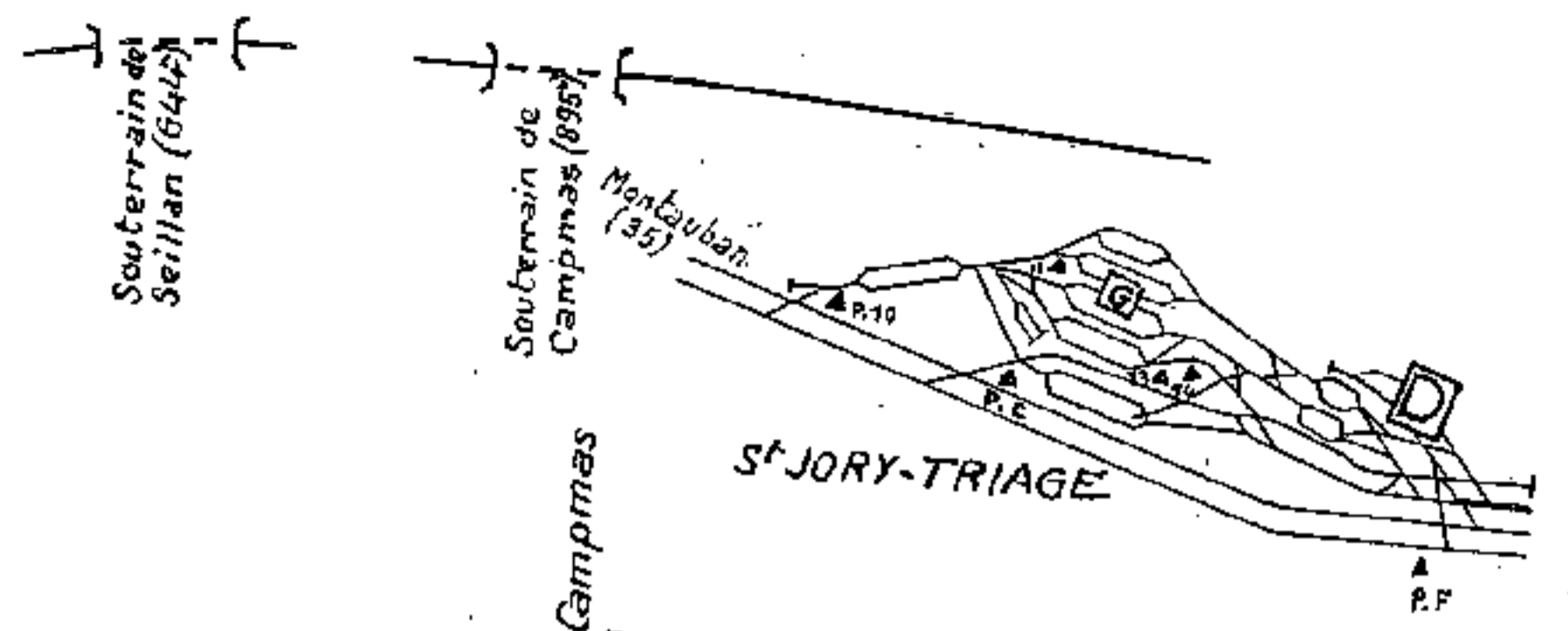
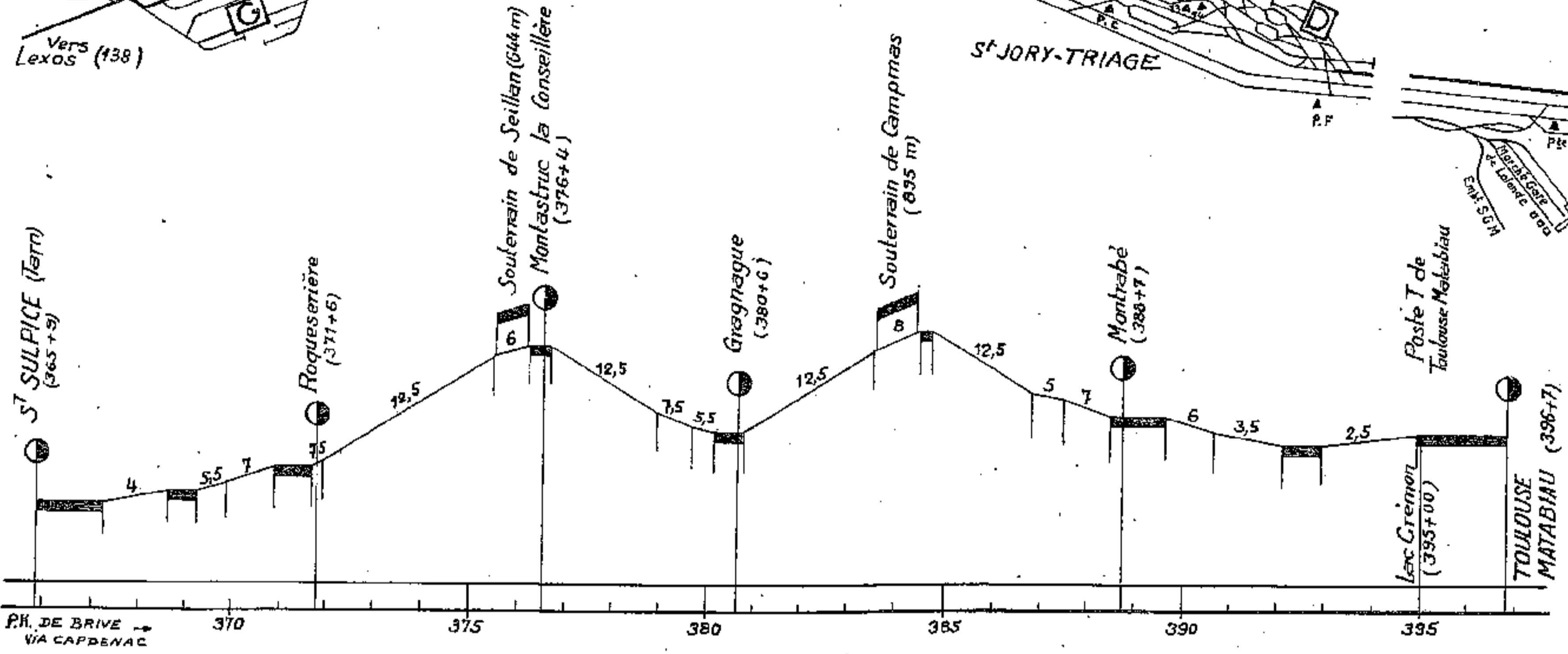
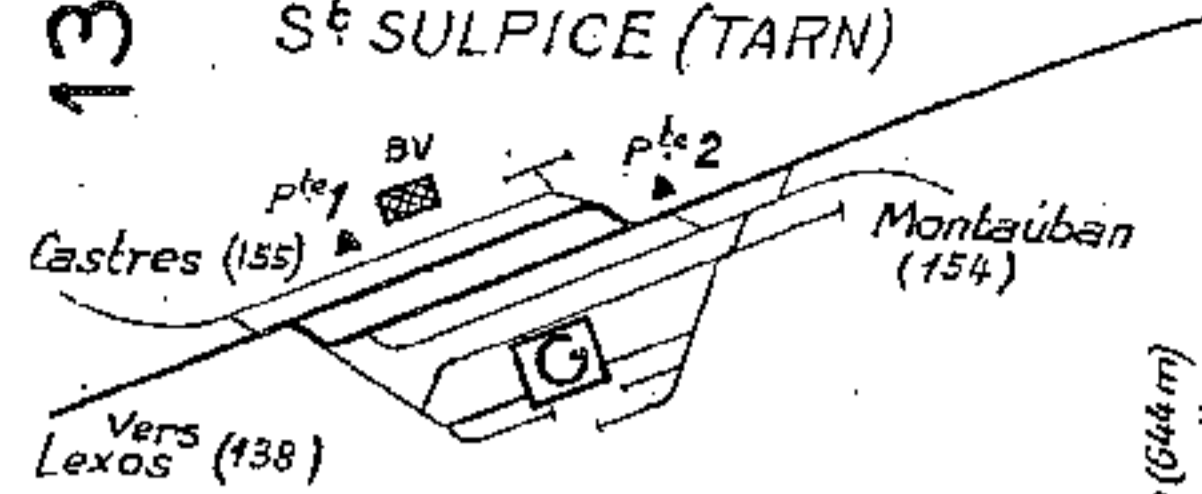

Ligne de Capdenac à Toulouse
Section de S^t Sulpice (Tarn) à Toulouse

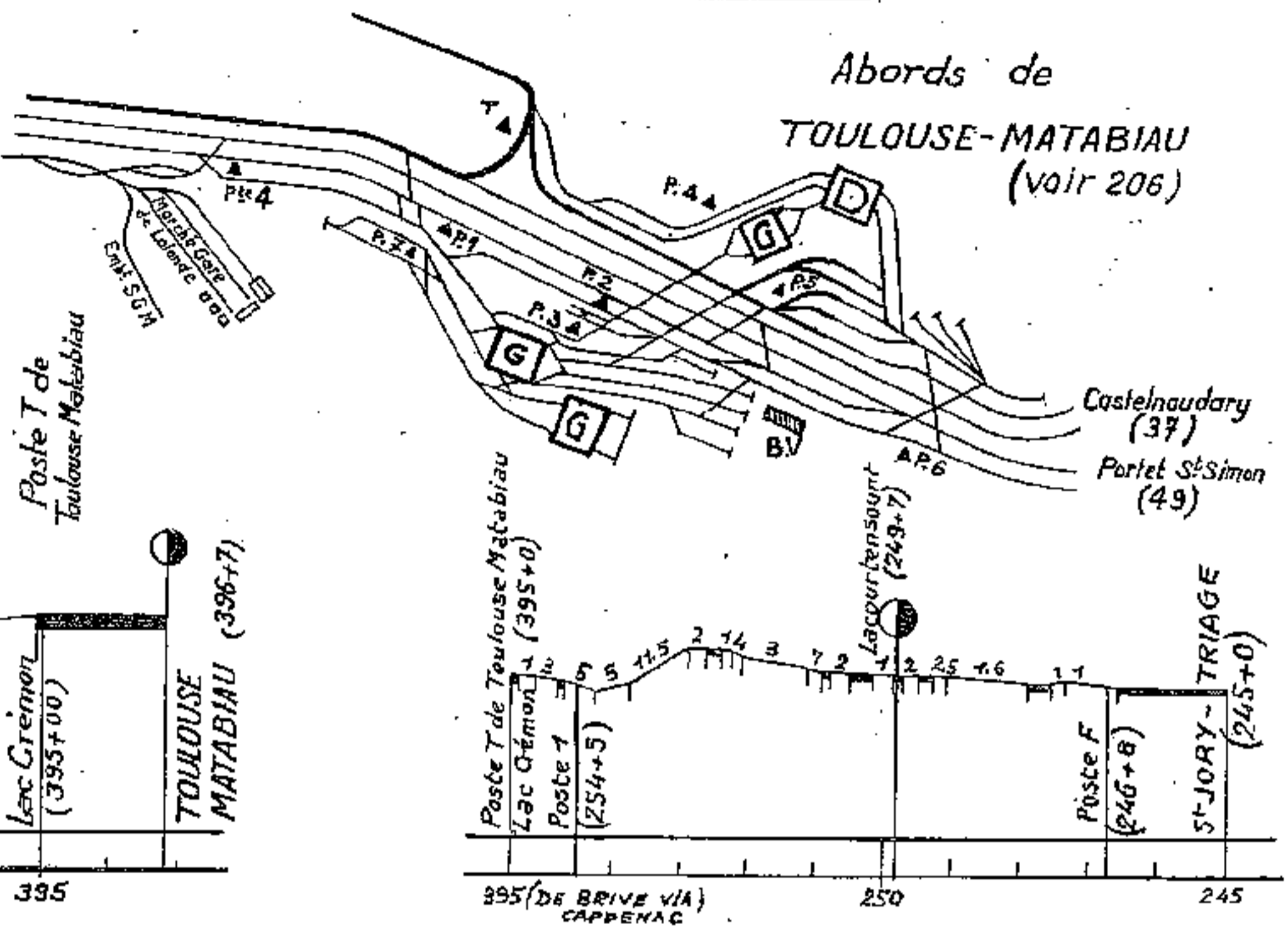

Abords de LEXOS

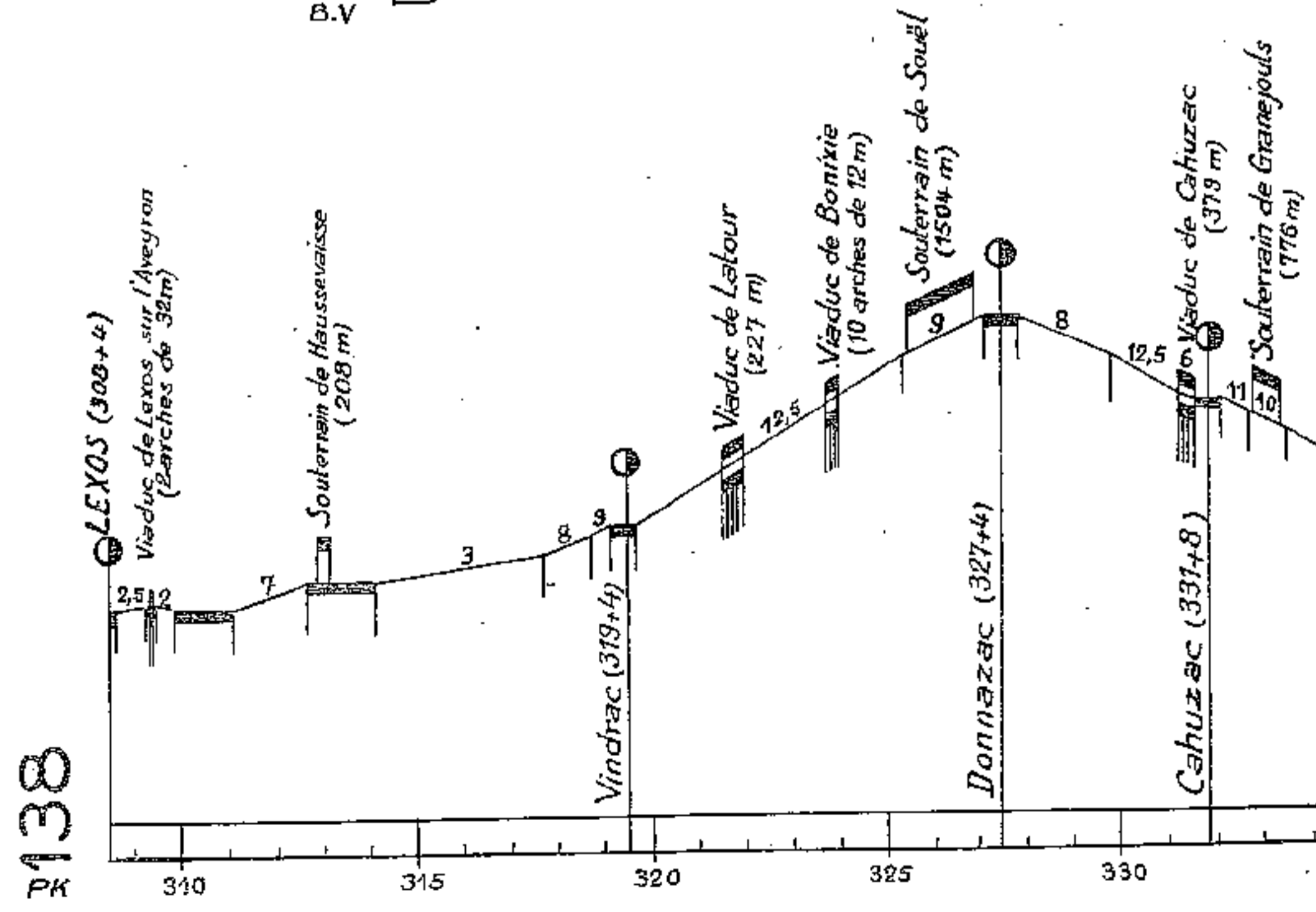
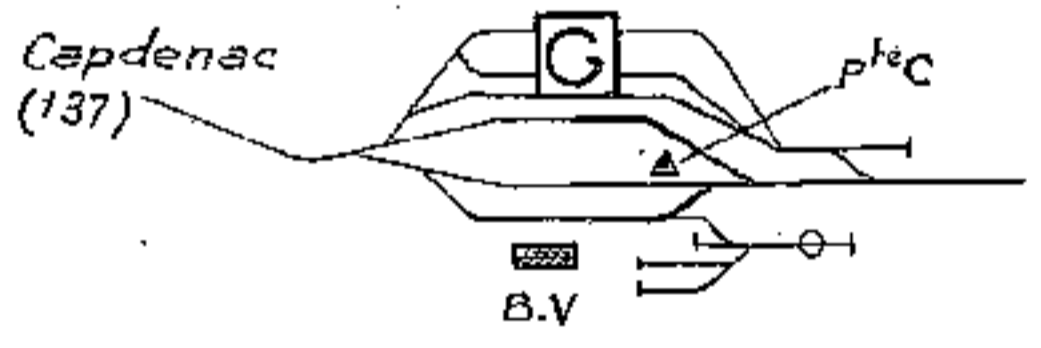

Abords de TESSONNIERES

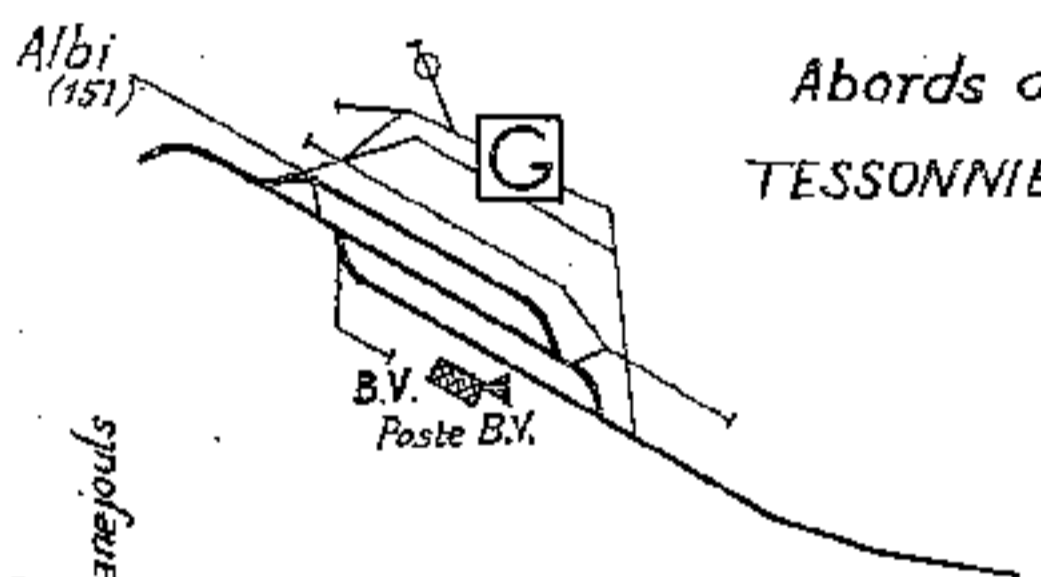

Ligne de Capdenac à Toulouse
Section de Lexos à S^t Sulpice (Tarn)

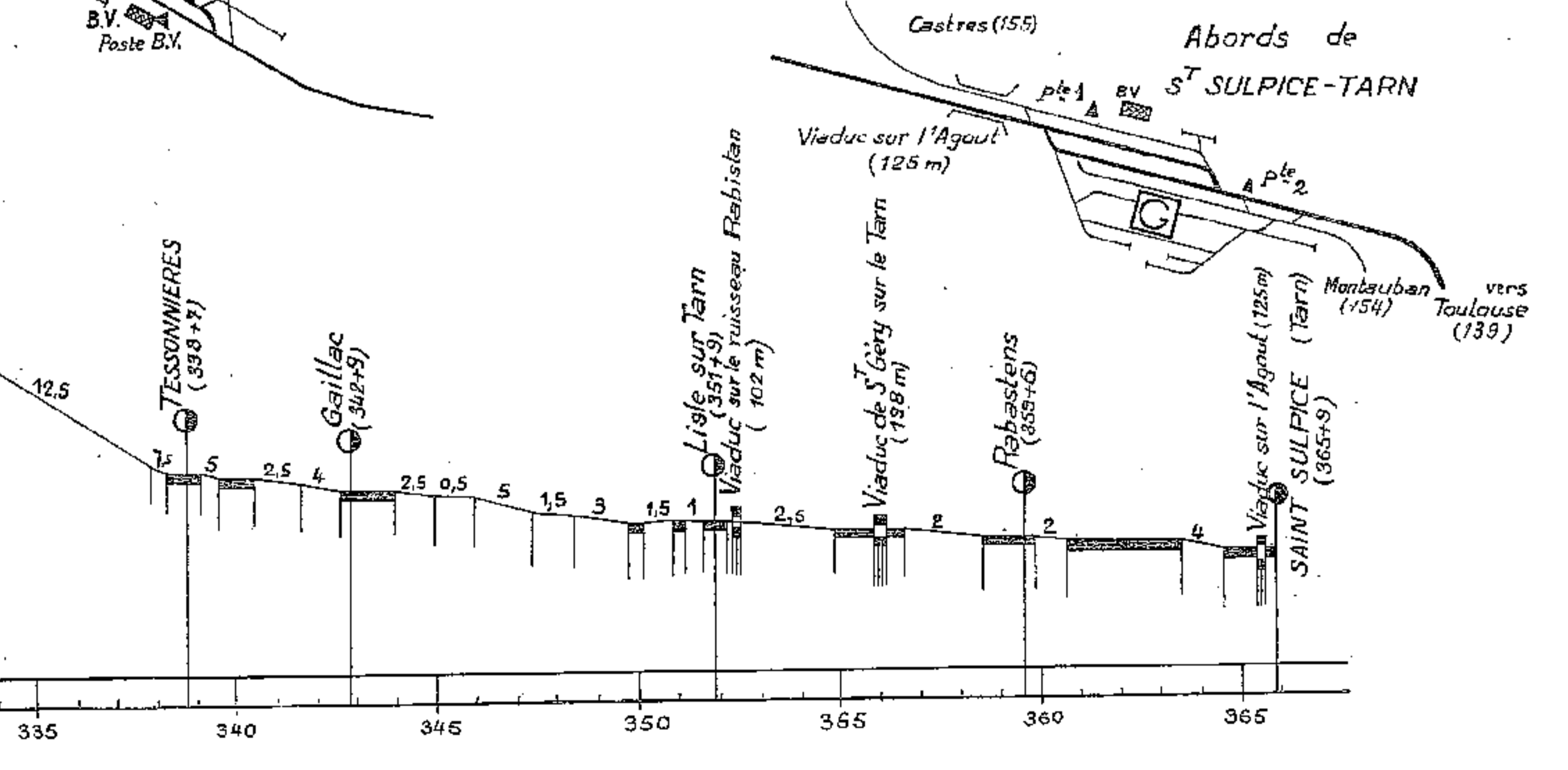

Abords de S^t SULPICE-TARN

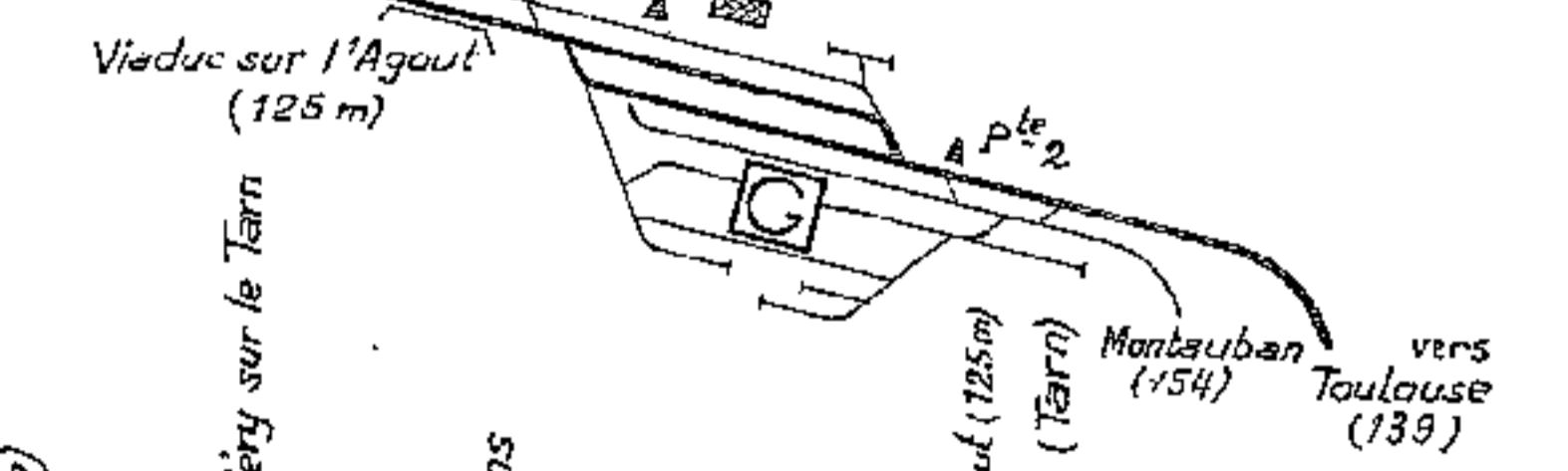

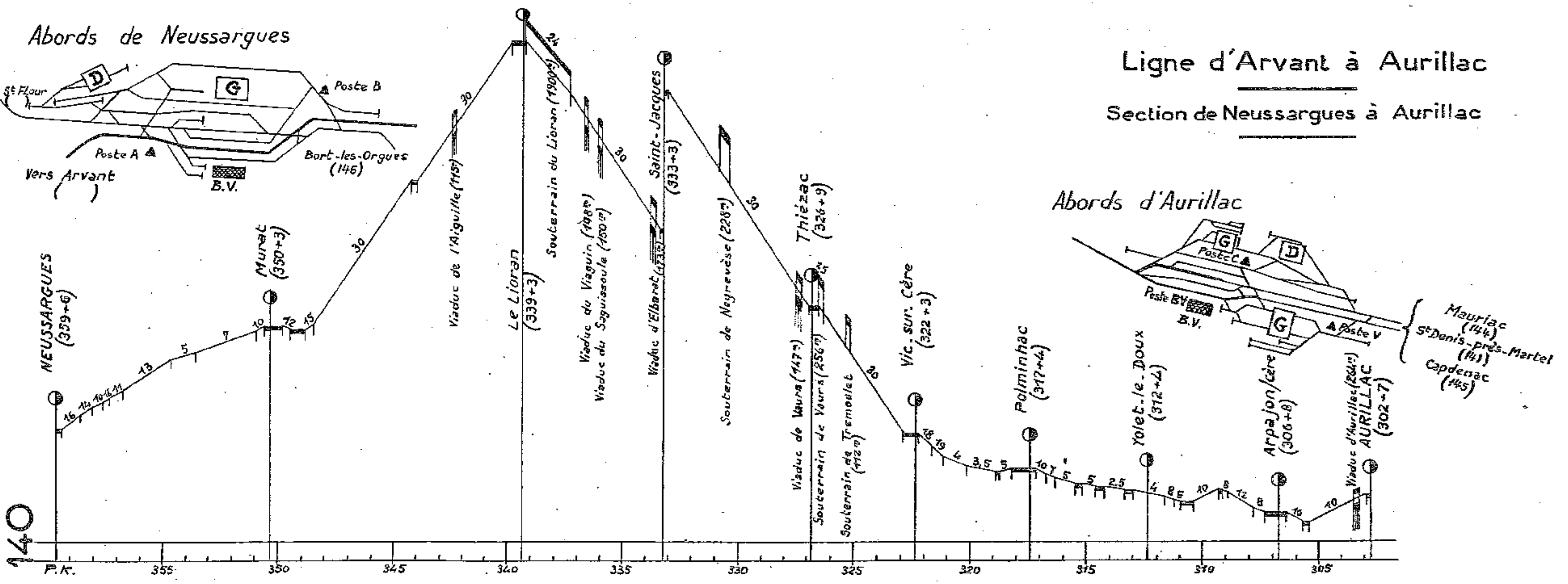
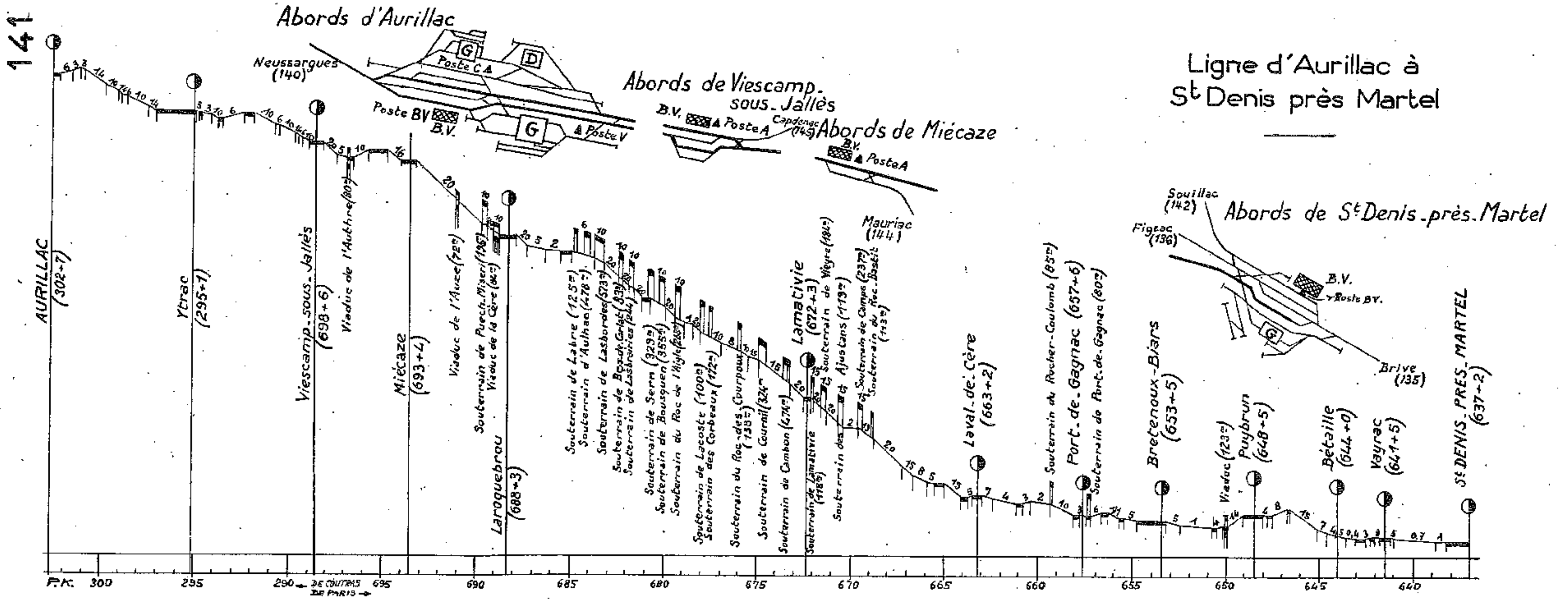

Abords de Bort-les-Orgues

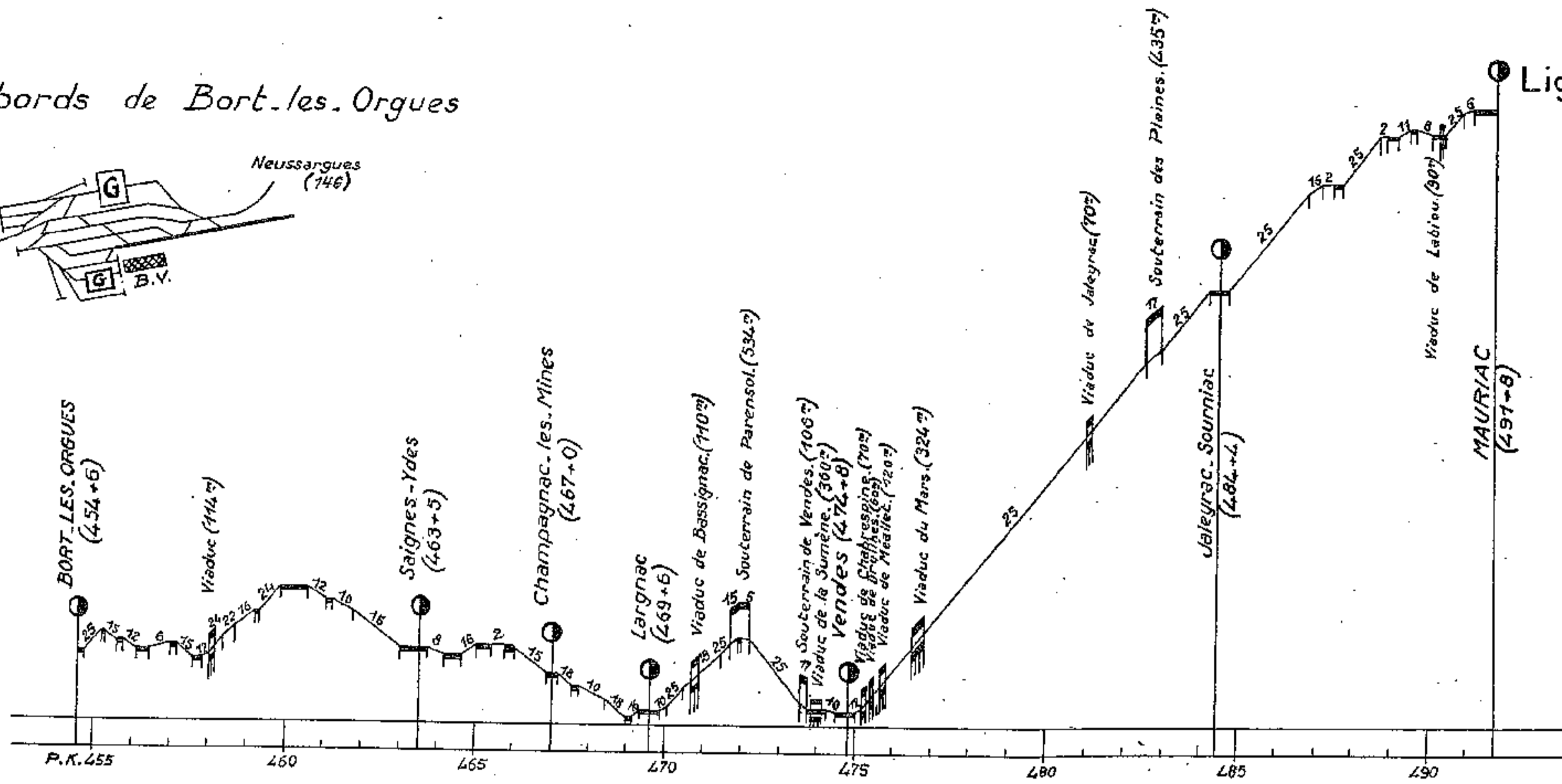
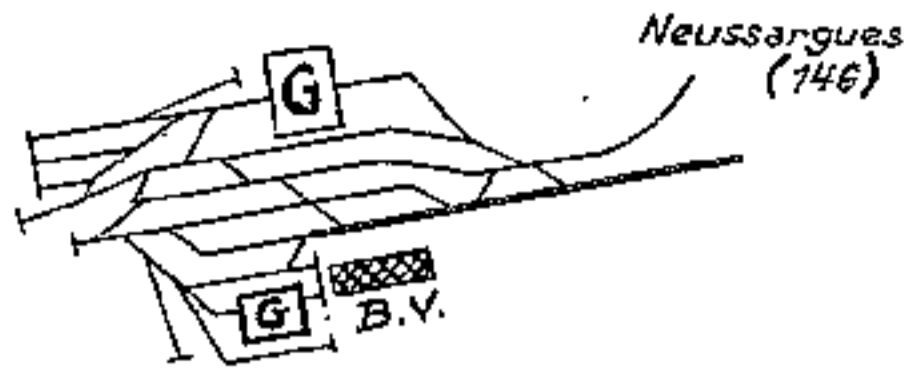

Abords de St Denis-près-Martel

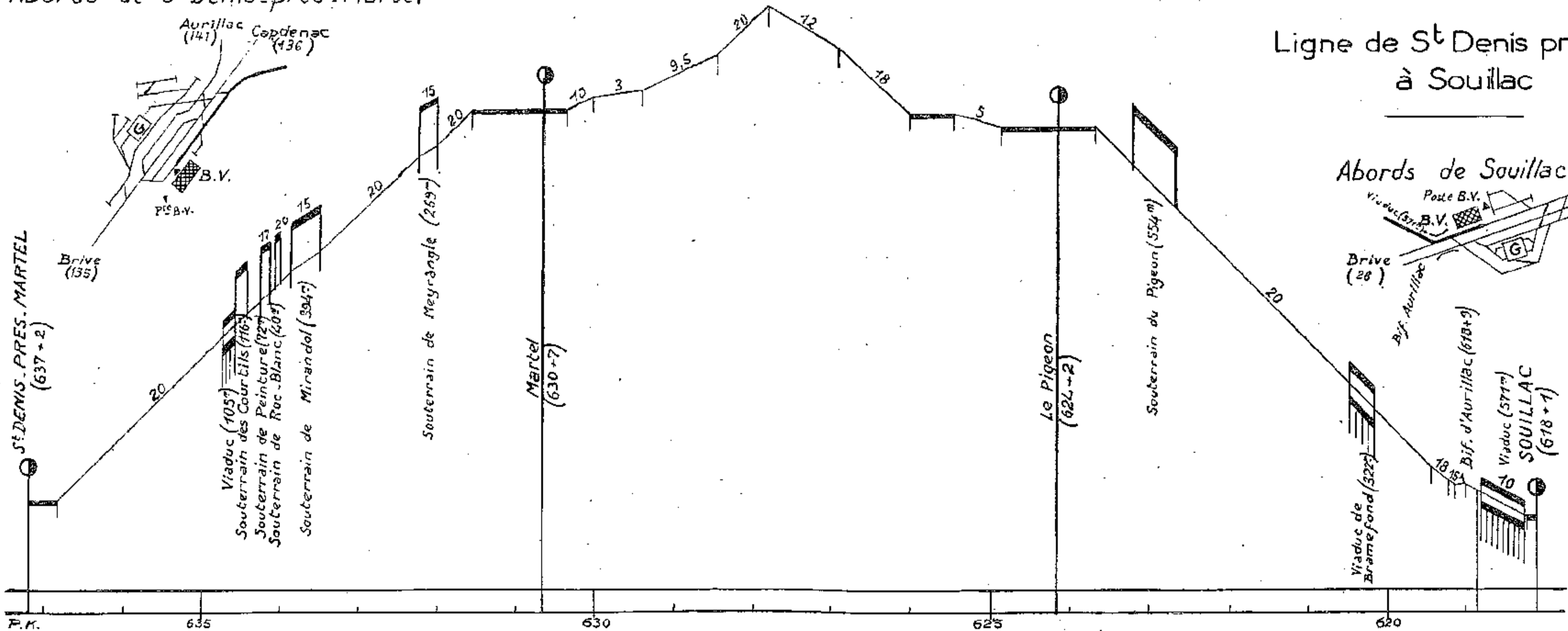
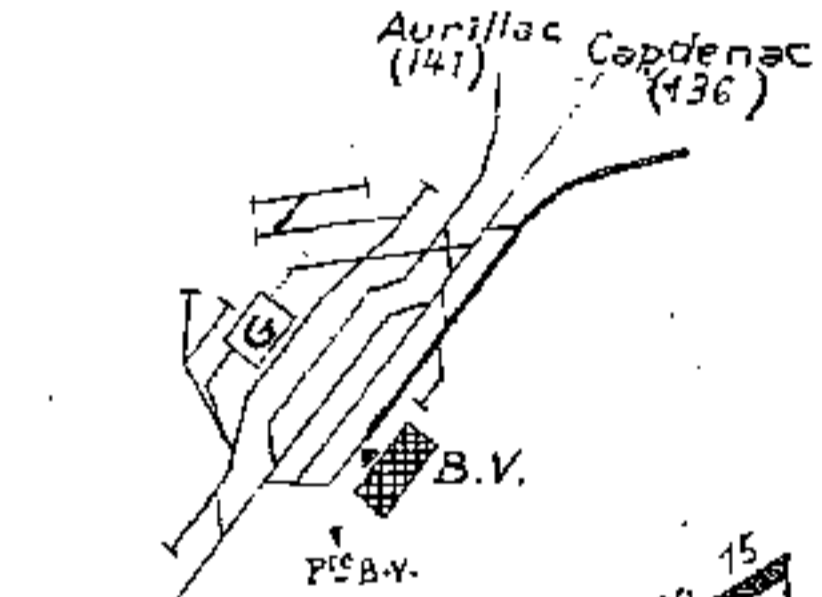

Ligne de St Denis près Martel à Souillac

Abords de Souillac

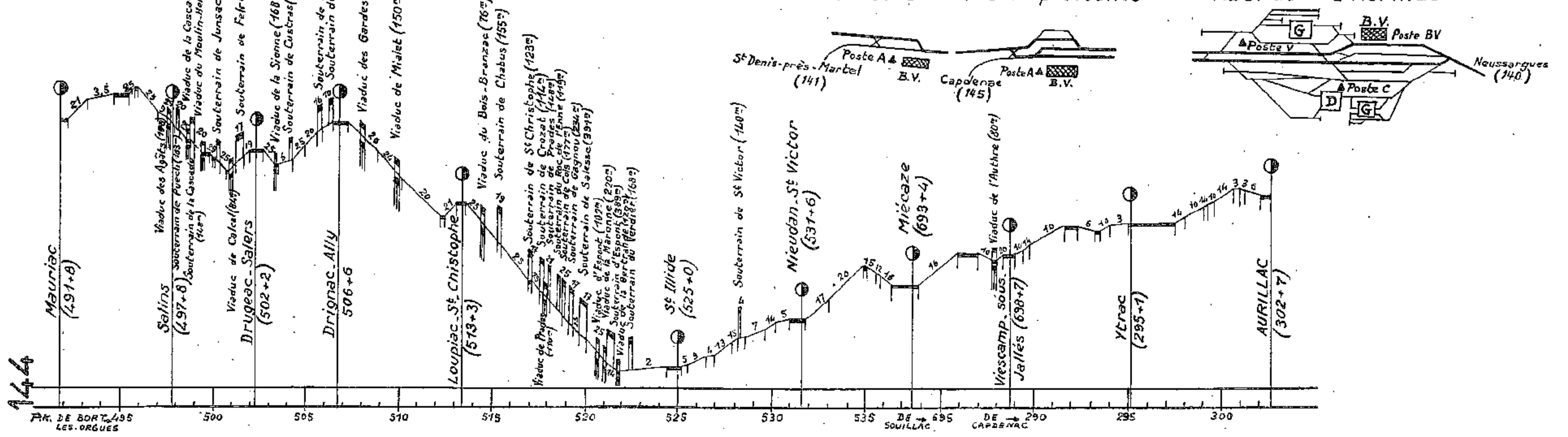
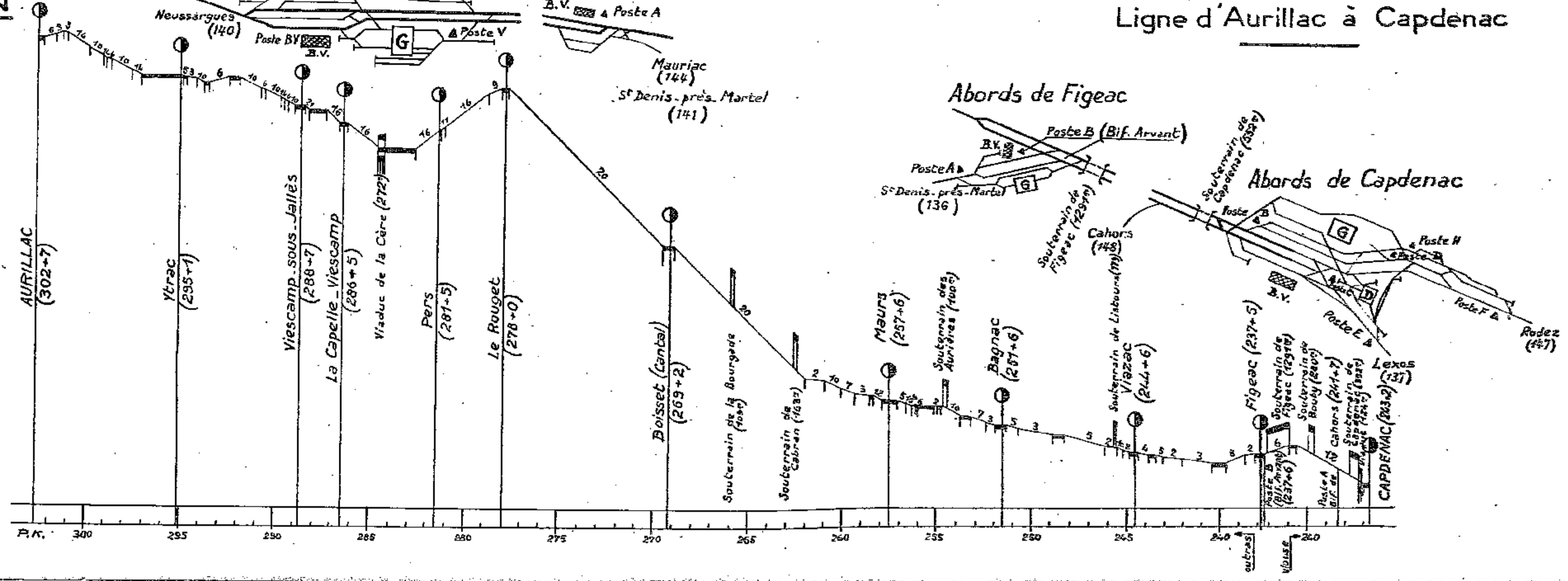

Abords de Capdenac

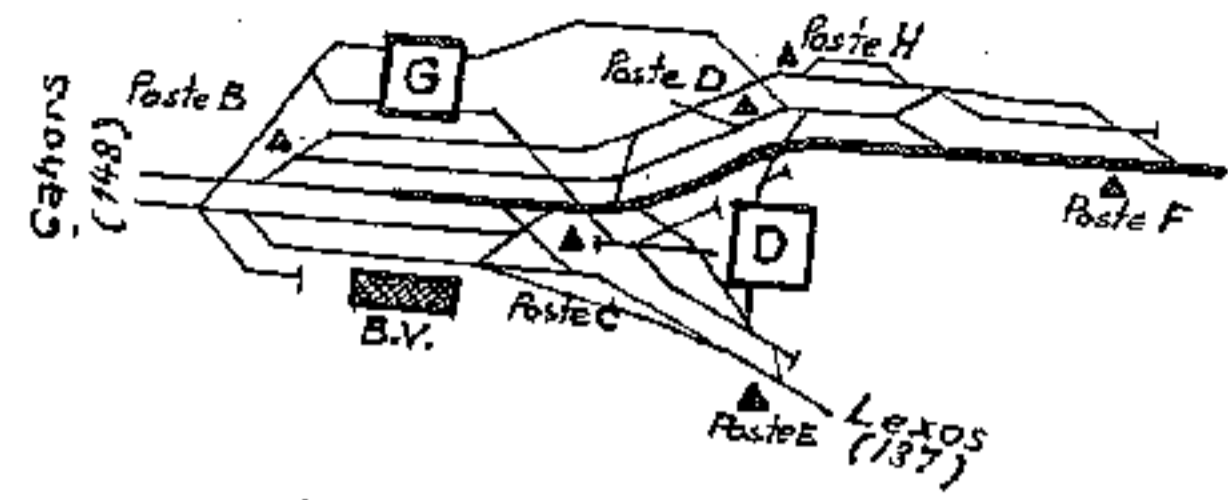

Abords de Viviez

Decazeville

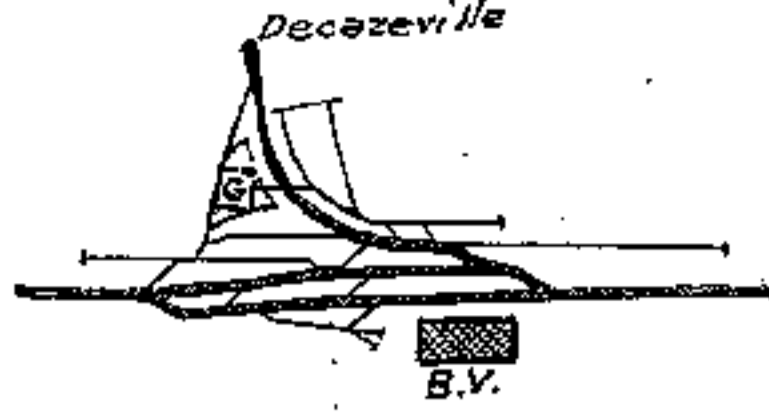

Abords de Rodez

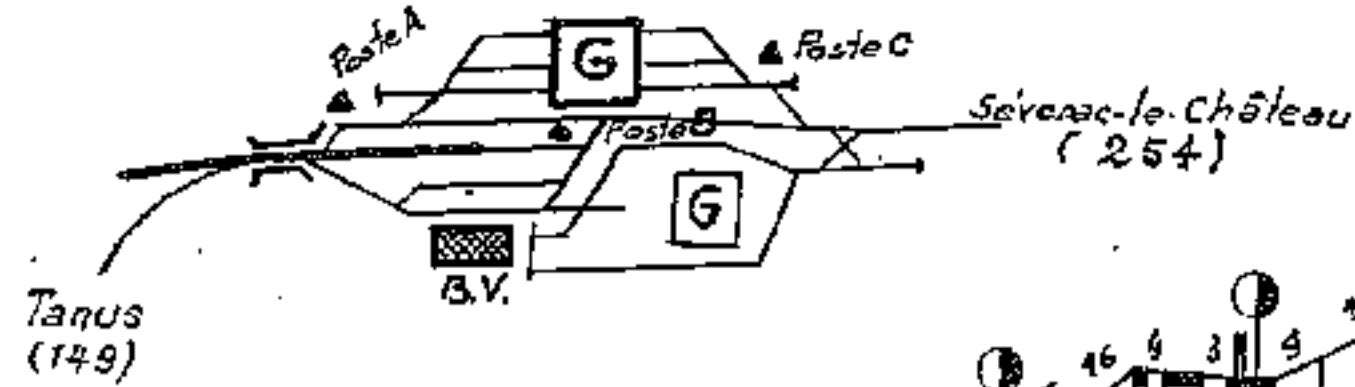

Lignes de Capdenac à Rodez et de Viviez à Decazeville

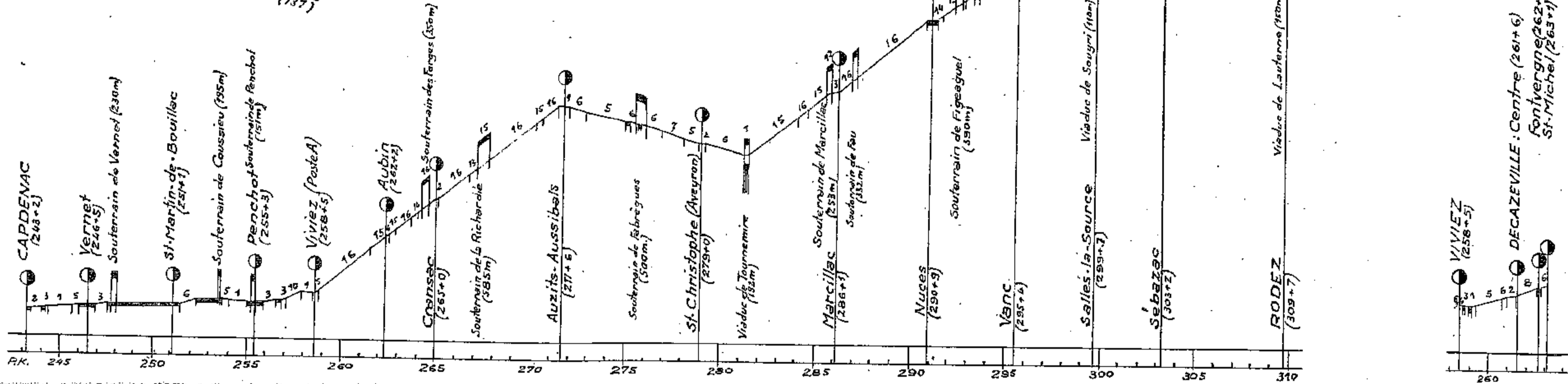

Abords de Bort-les-Orgues

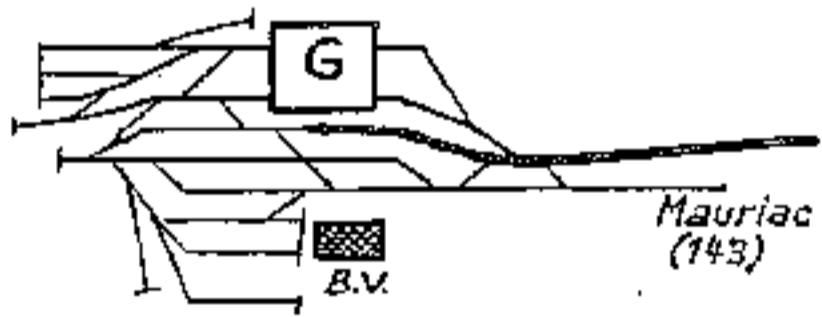

Ligne de Bort les Orgues à Neussargues

Abords de Neussargues

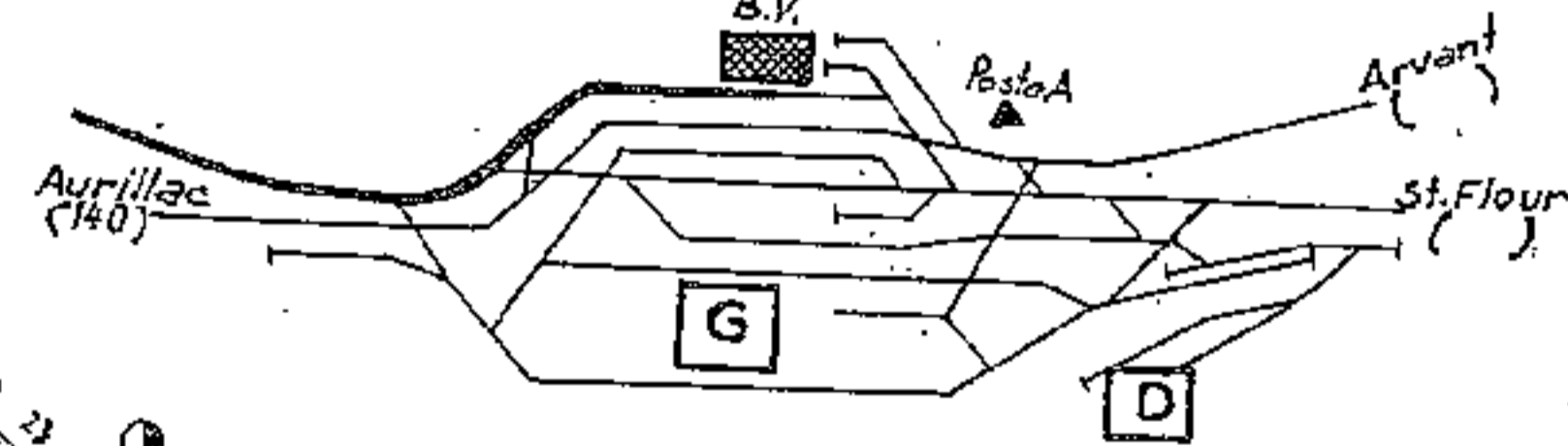

BORT-LES-ORGUES

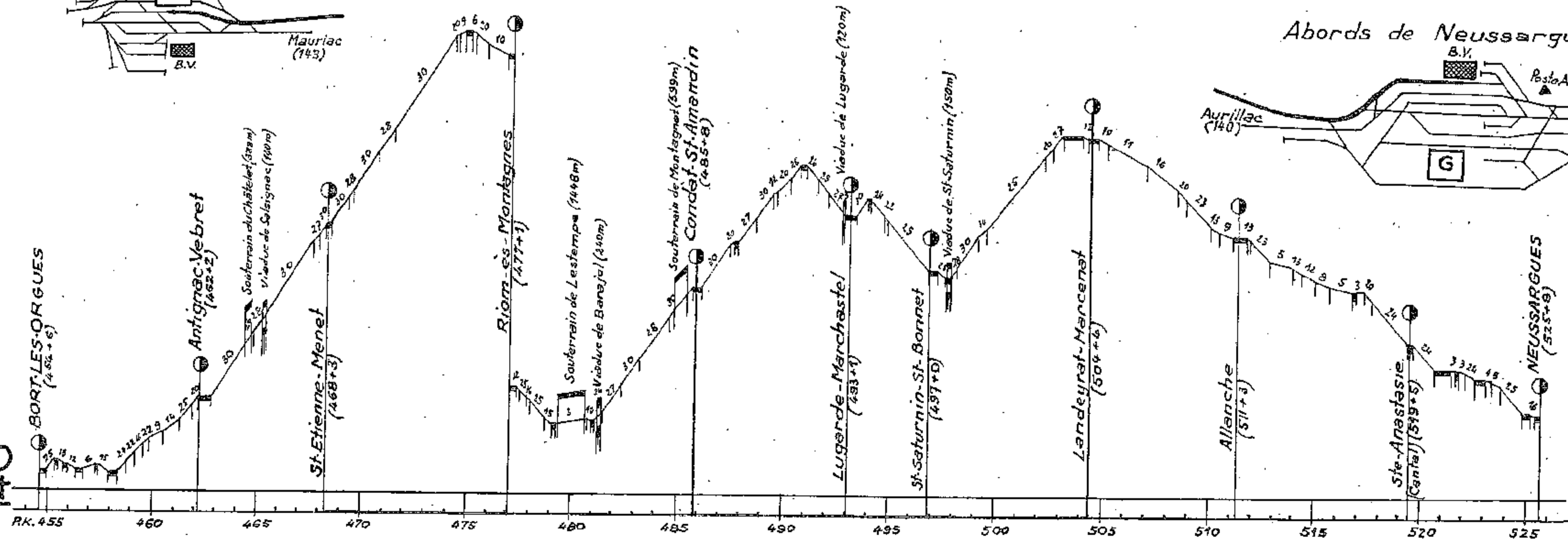

Séverac-le-Château (254)

Abords de Rodez

Ligne de Rodez à Albi-Ville

Section de Rodez à Tanus

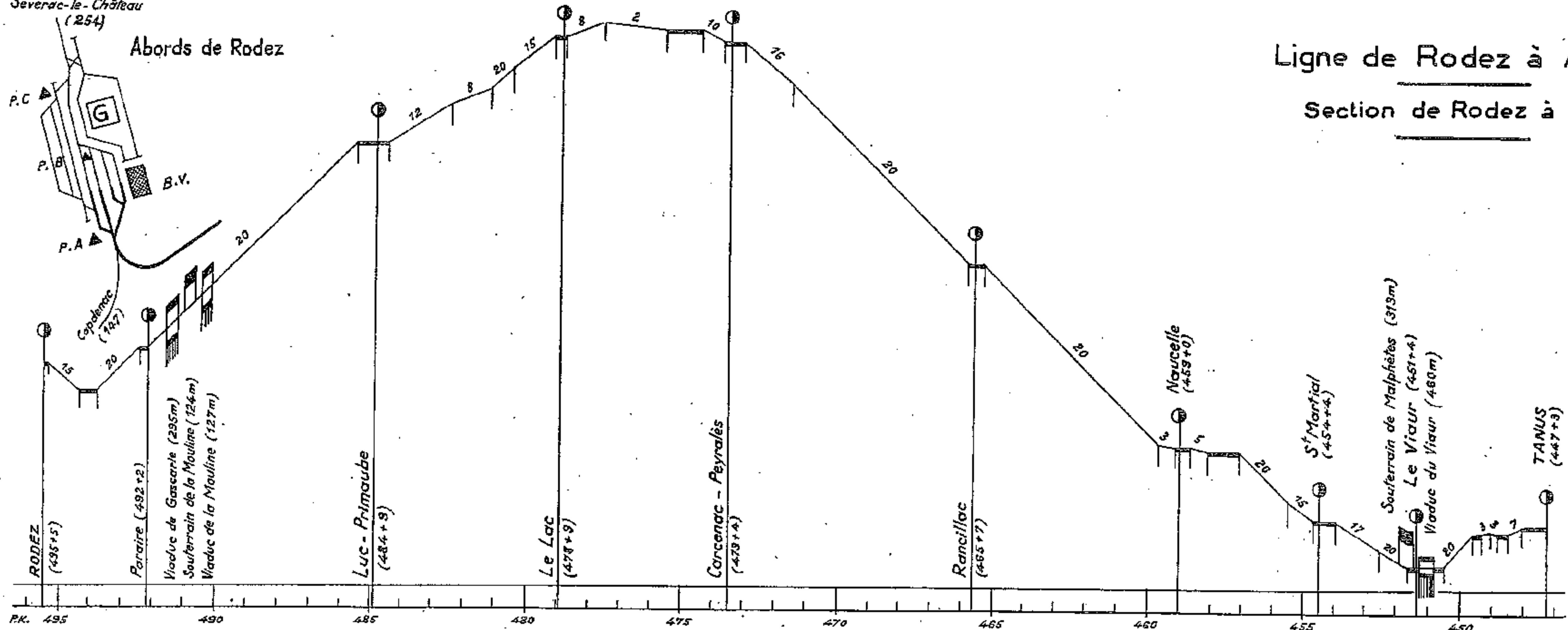

Gourdon (29)

Abords de CAHORS

Abords de CAPDENAC

Ligne de Cahors à Capdenac

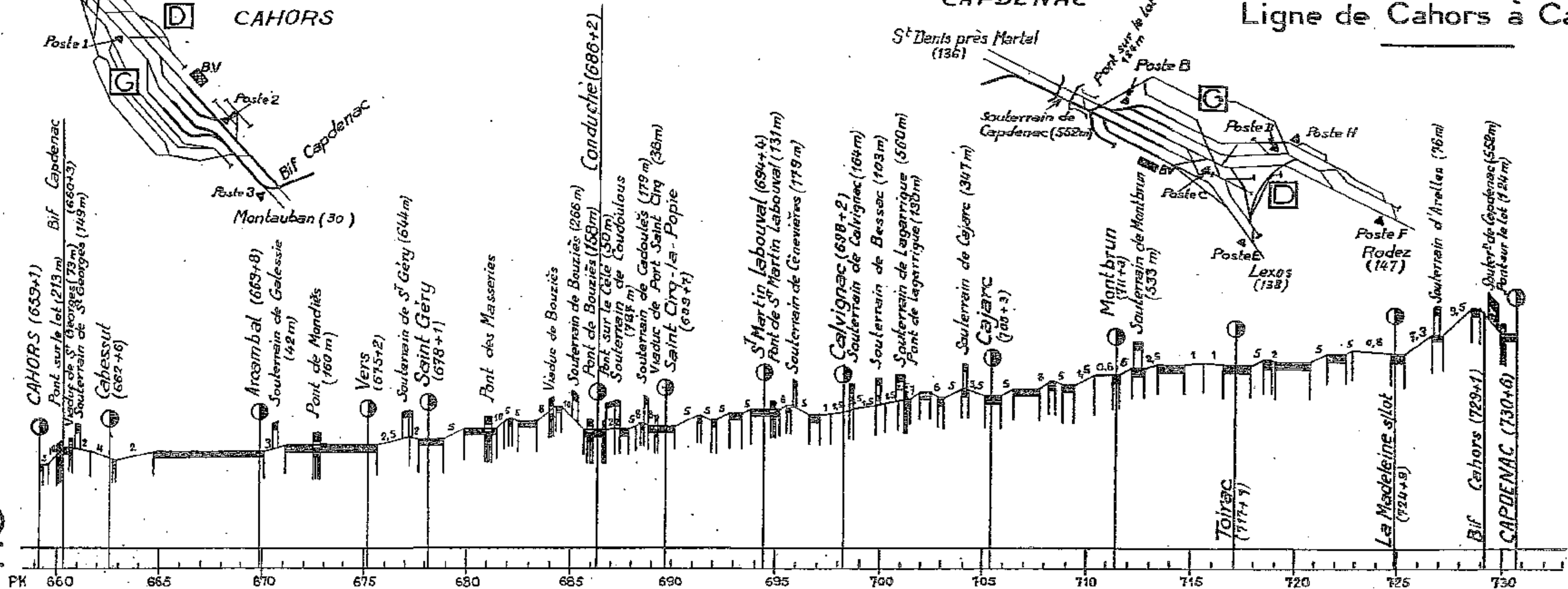

Abords d'Albi-Ville
vers S^tJuéry
Castres (152)

Abords de Tessonnières

Lignes d'Albi-Ville à Tessonnières
et d'Albi-Ville à S^tJuéry

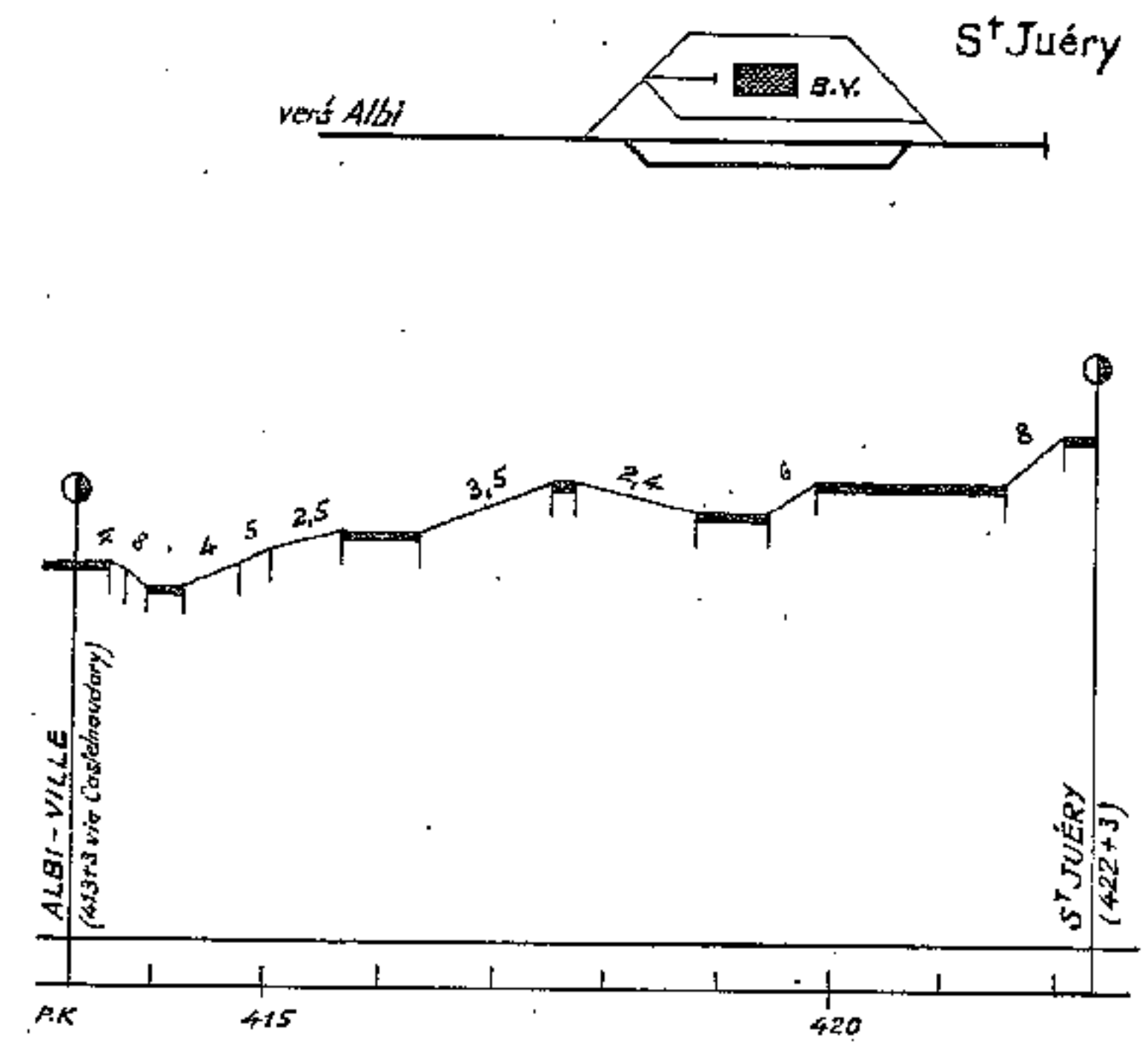
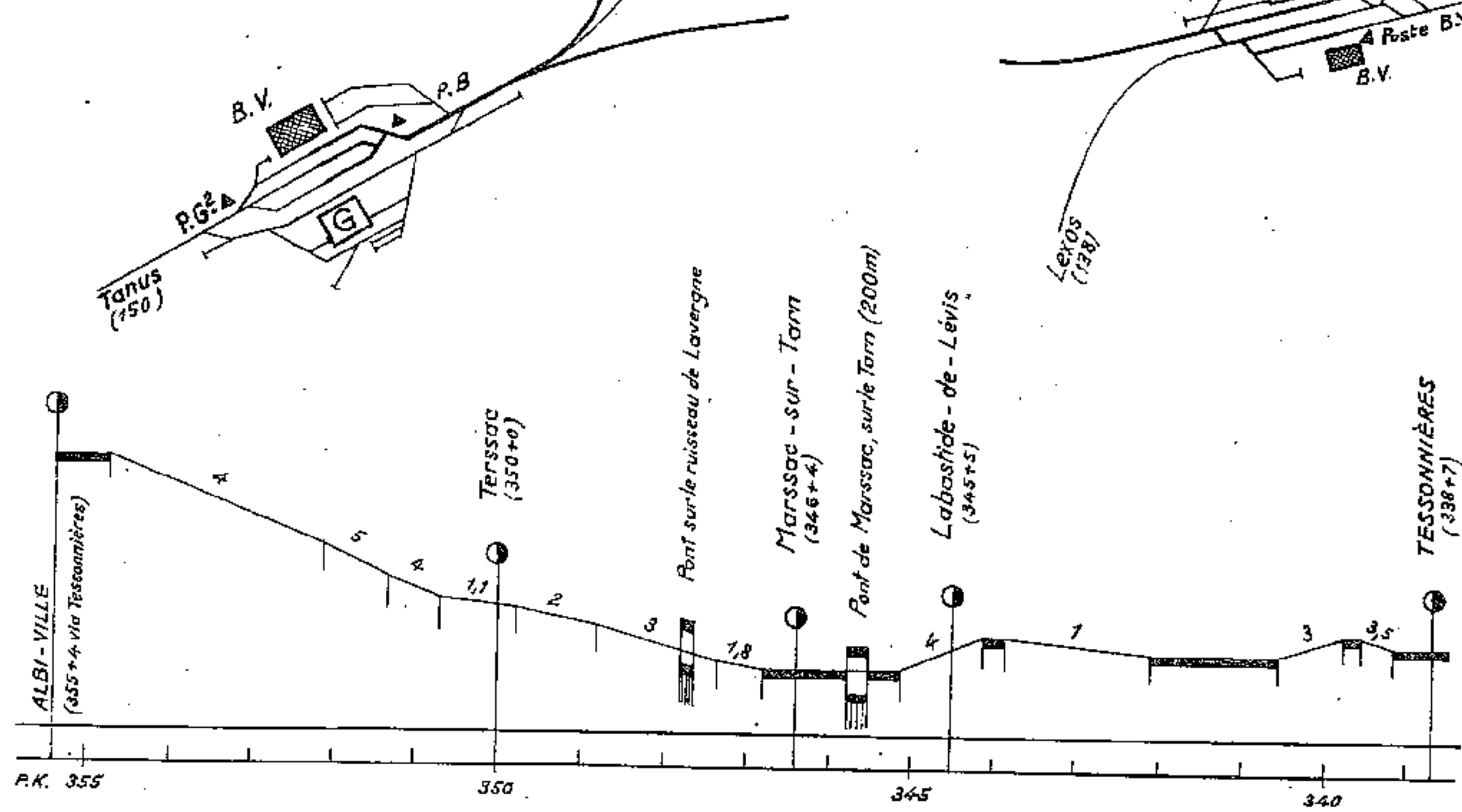

Abords de Carmaux

Ligne de Rodez à Albi-Ville

Section de Tanus à Albi-Ville

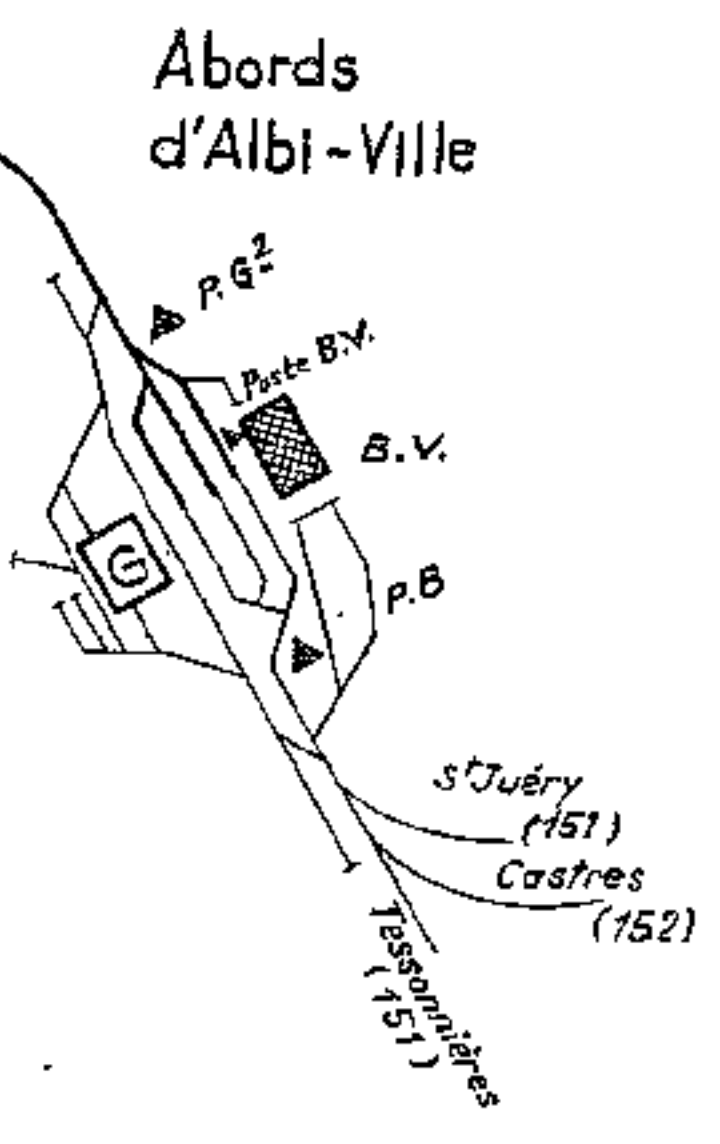
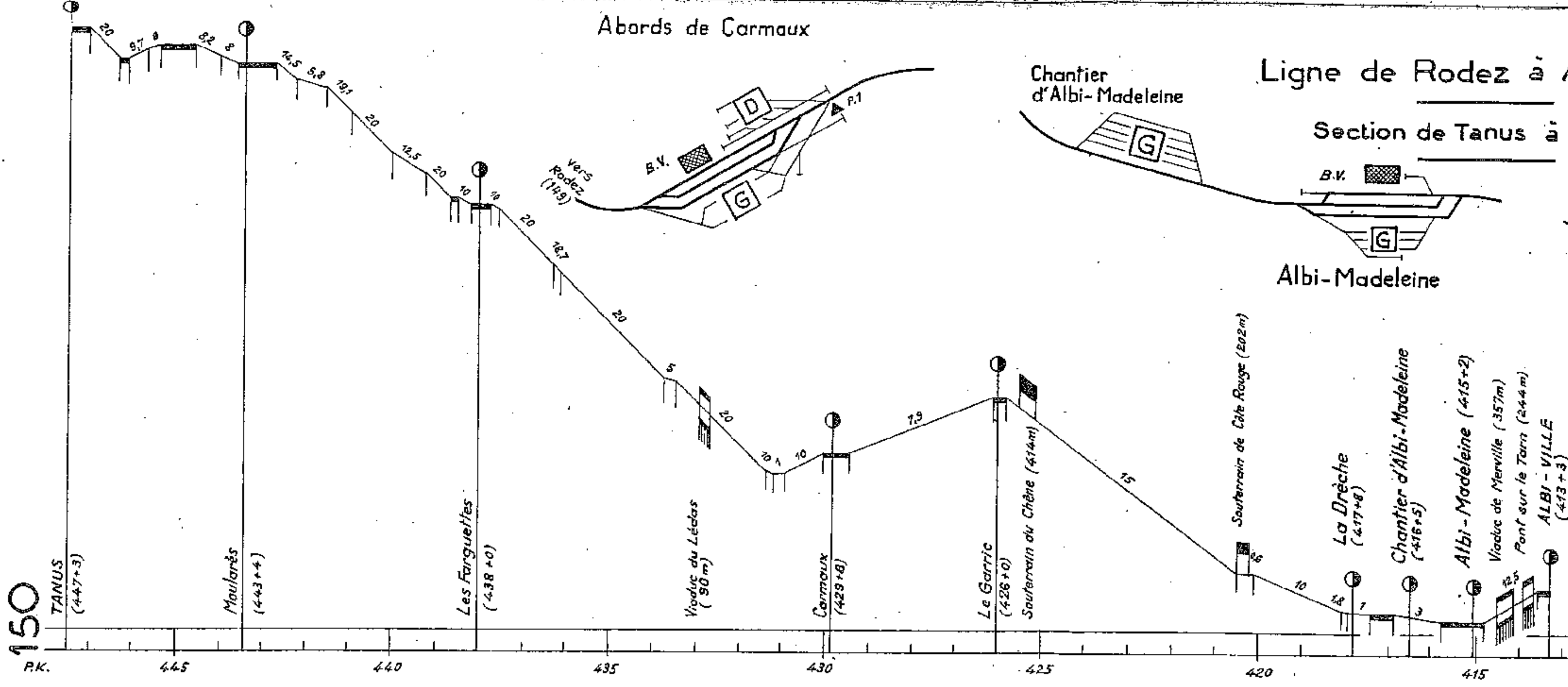

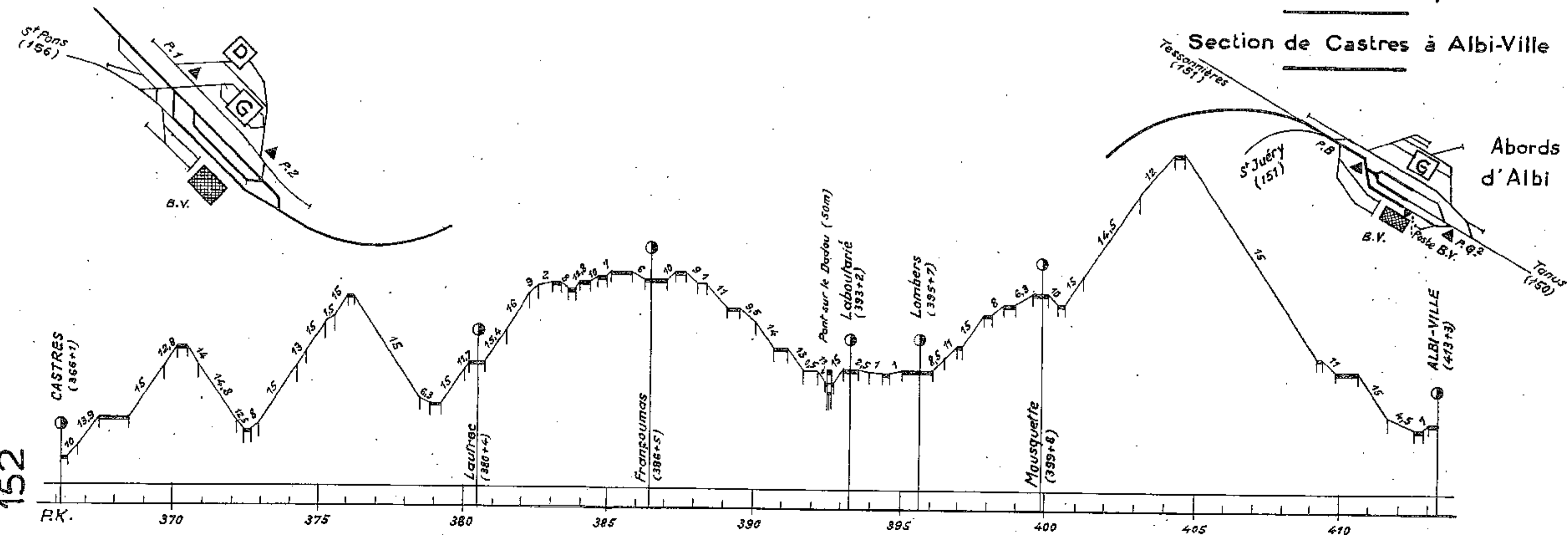
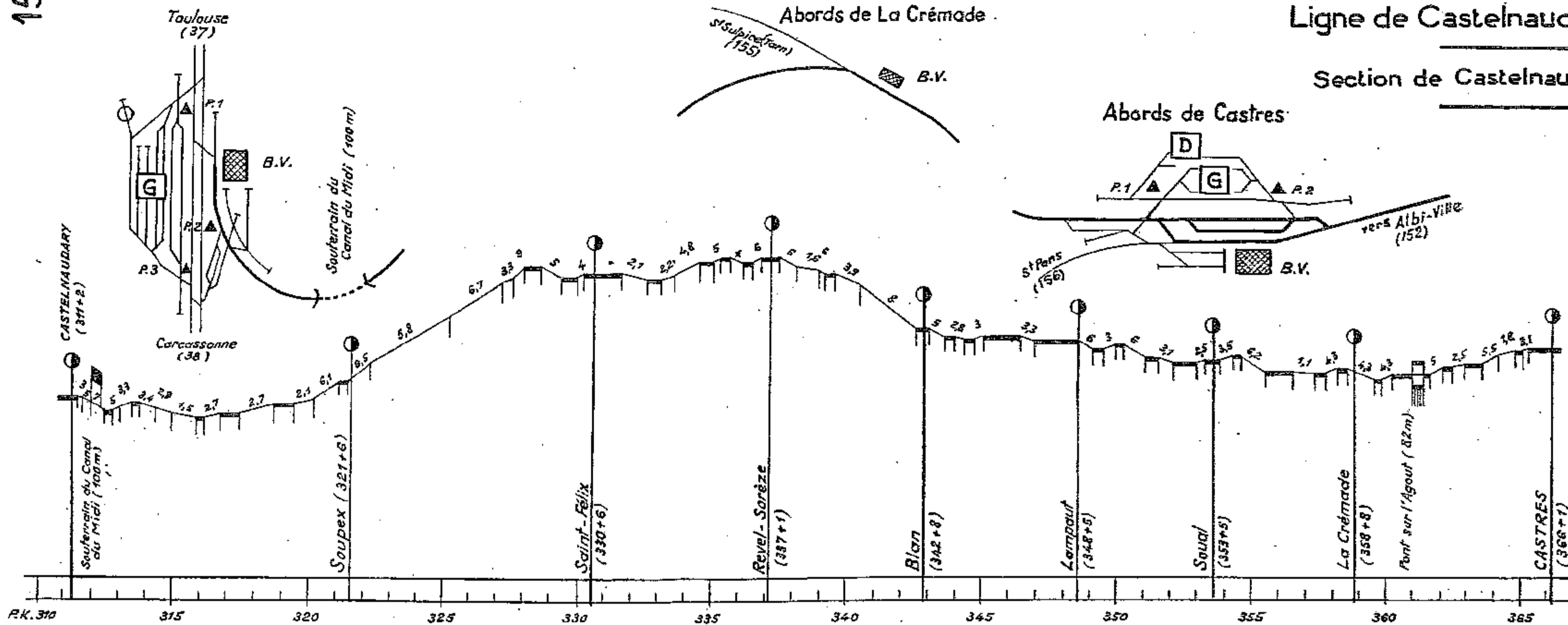

Abords de St Sulpice - Tarn

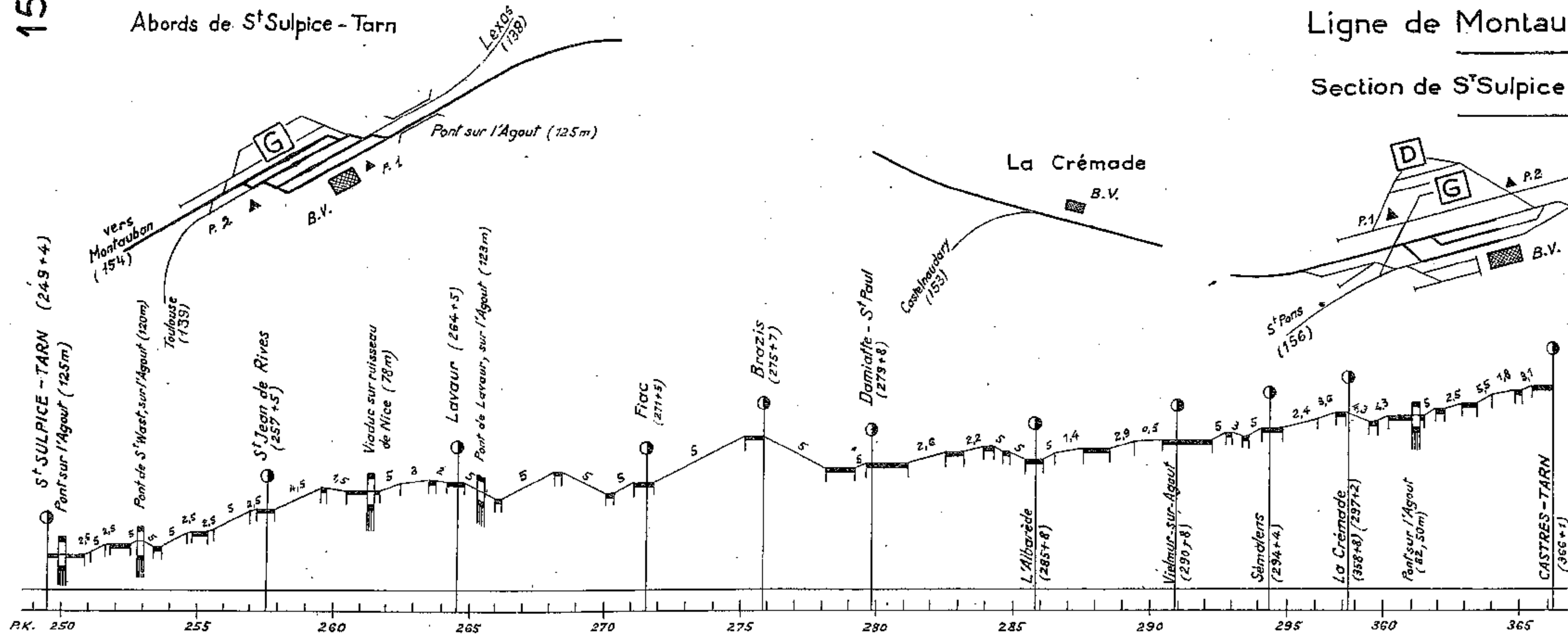

Ligne de Montauban à Castres

Section de St Sulpice (Tarn) à Castres

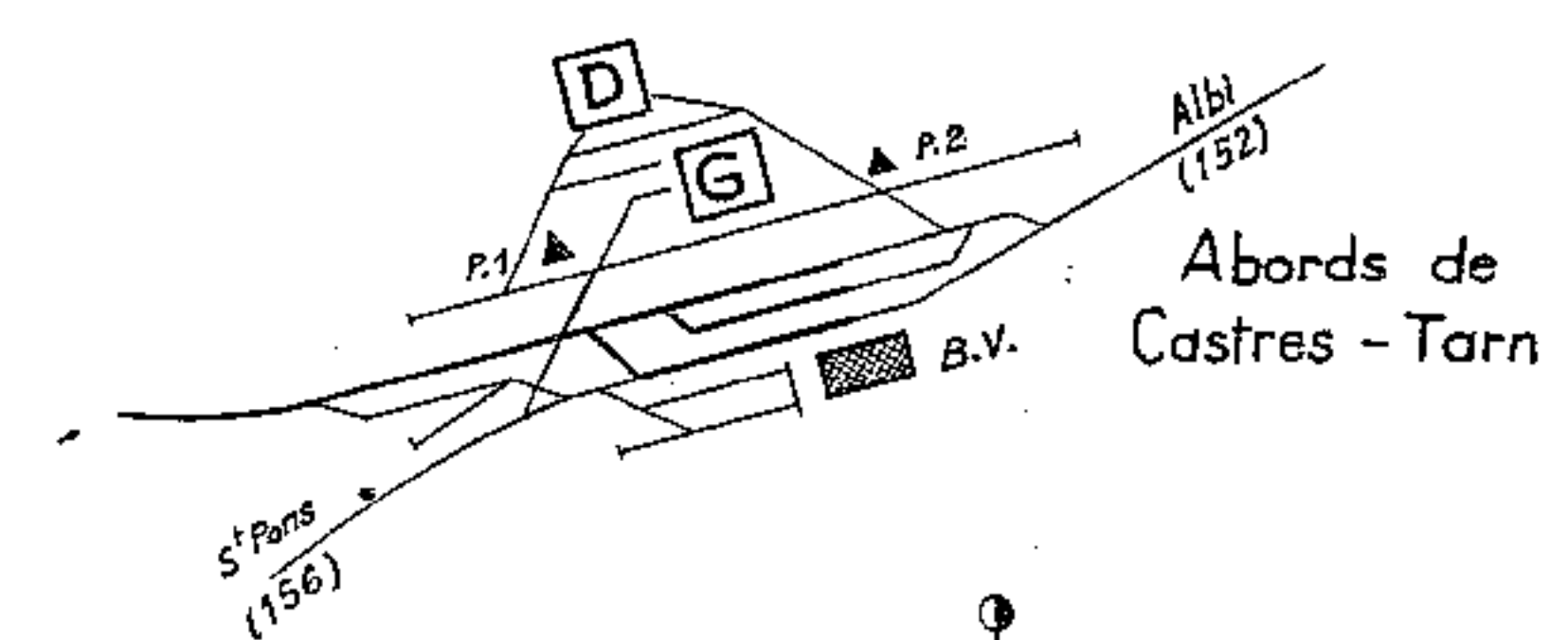

Abords de Castres - Tarn

Abords de Montauban

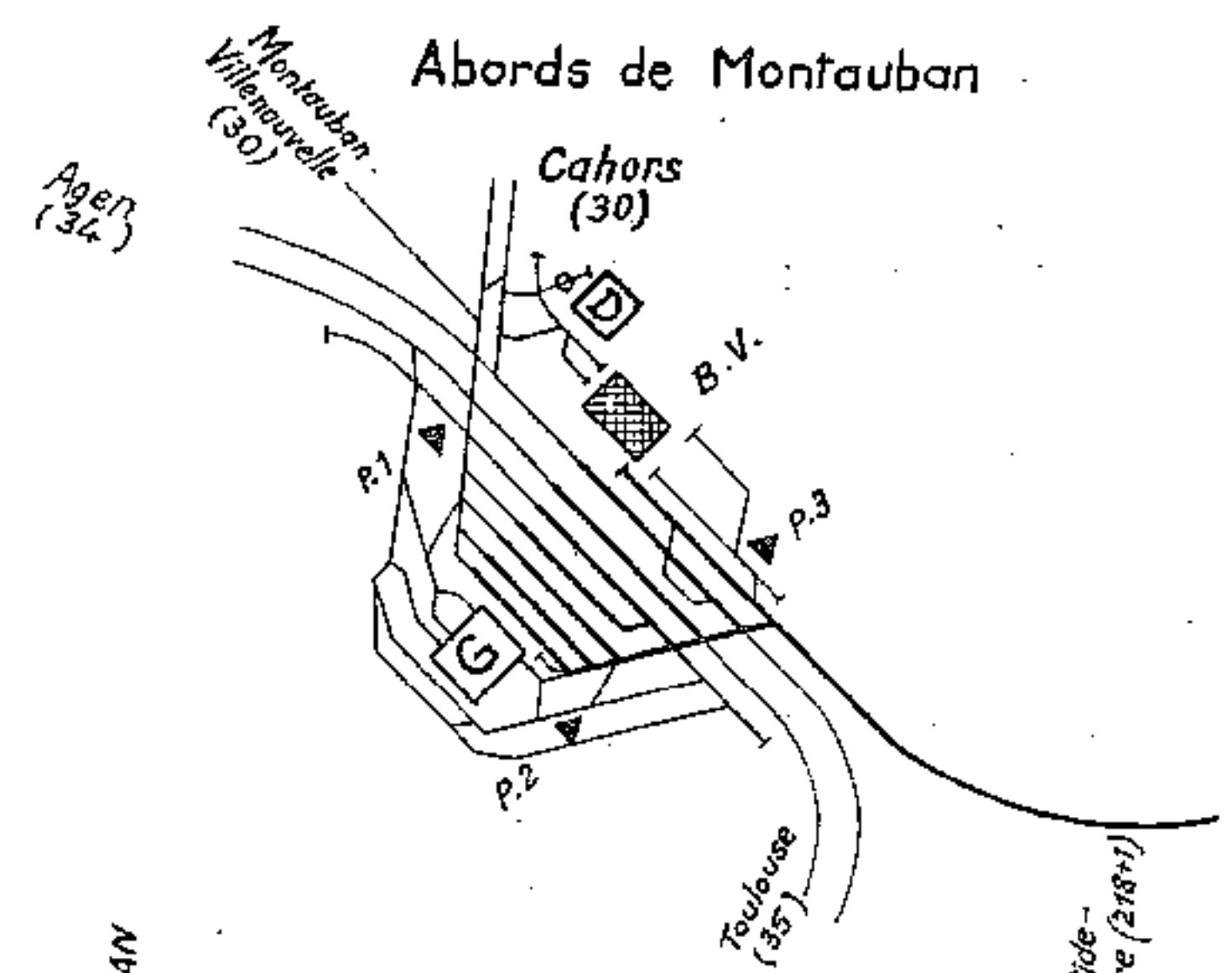

Ligne de Montauban à Castres

Section de Montauban à St Sulpice (Tarn)

Abords de St Sulpice - Tarn

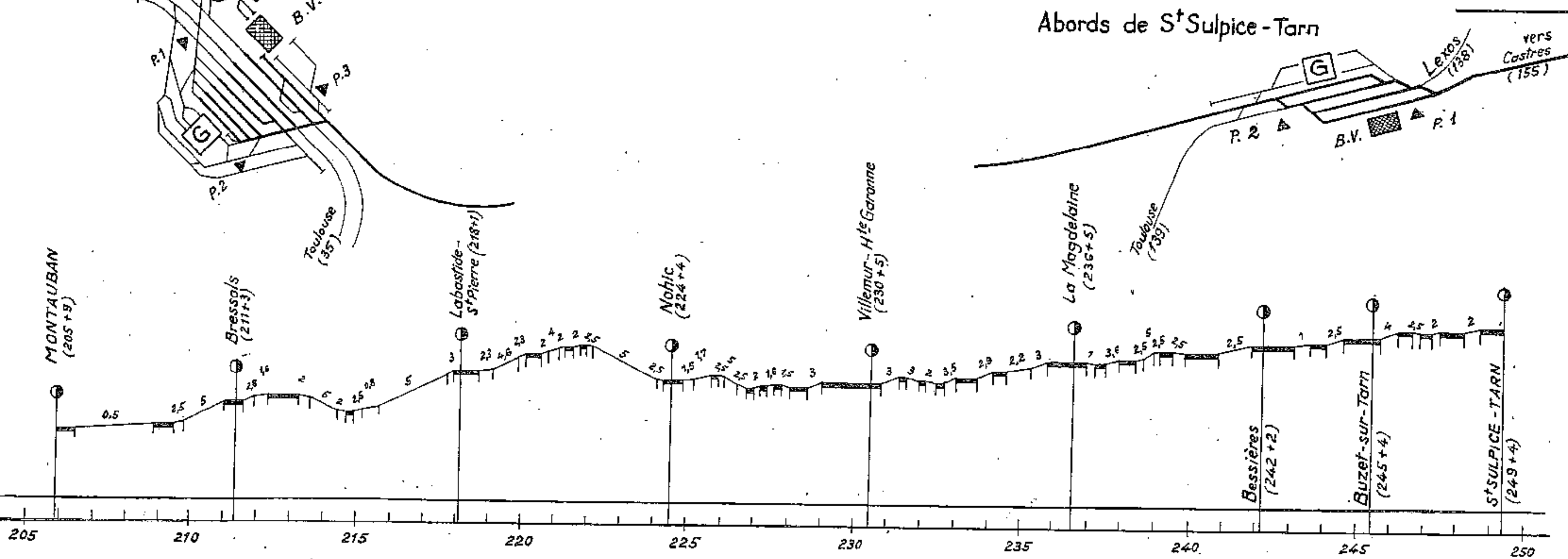

St Sulpice - Tarn

Ligne de Moux à Caunes-Minervois

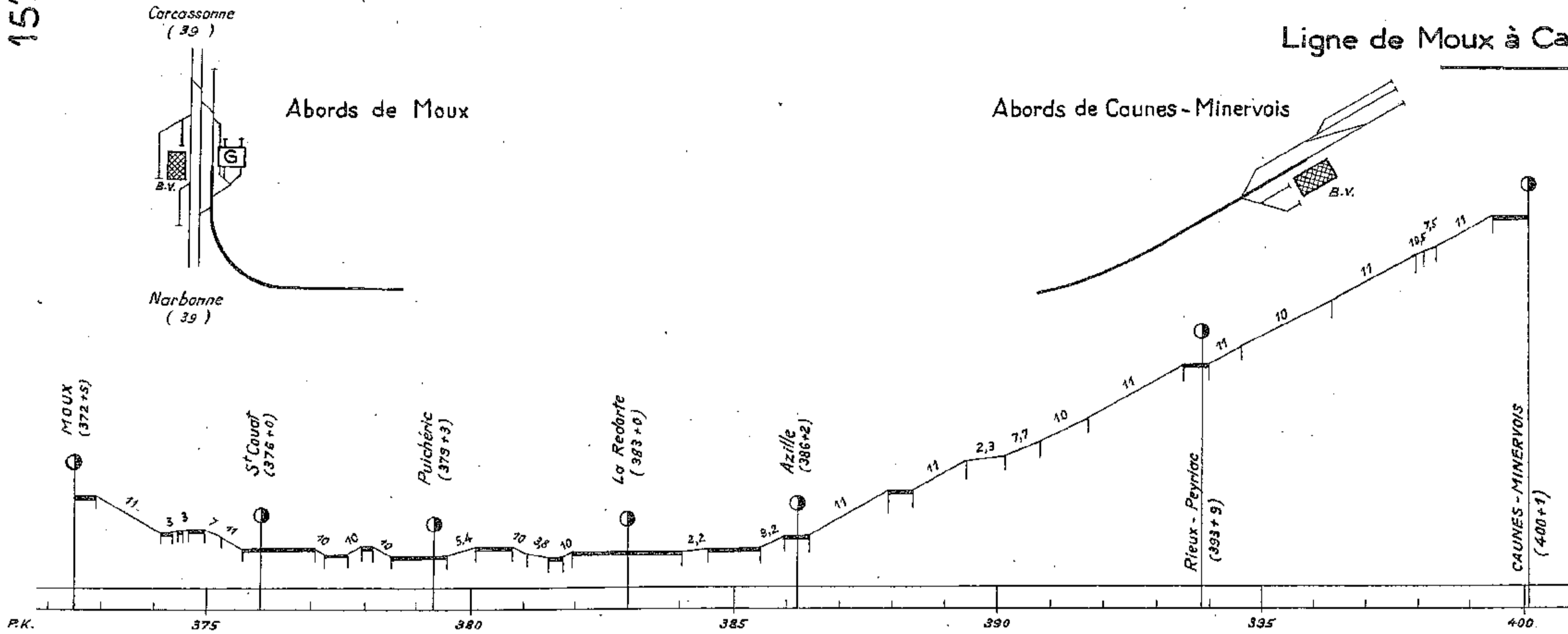

Ligne de Castres à St Pons

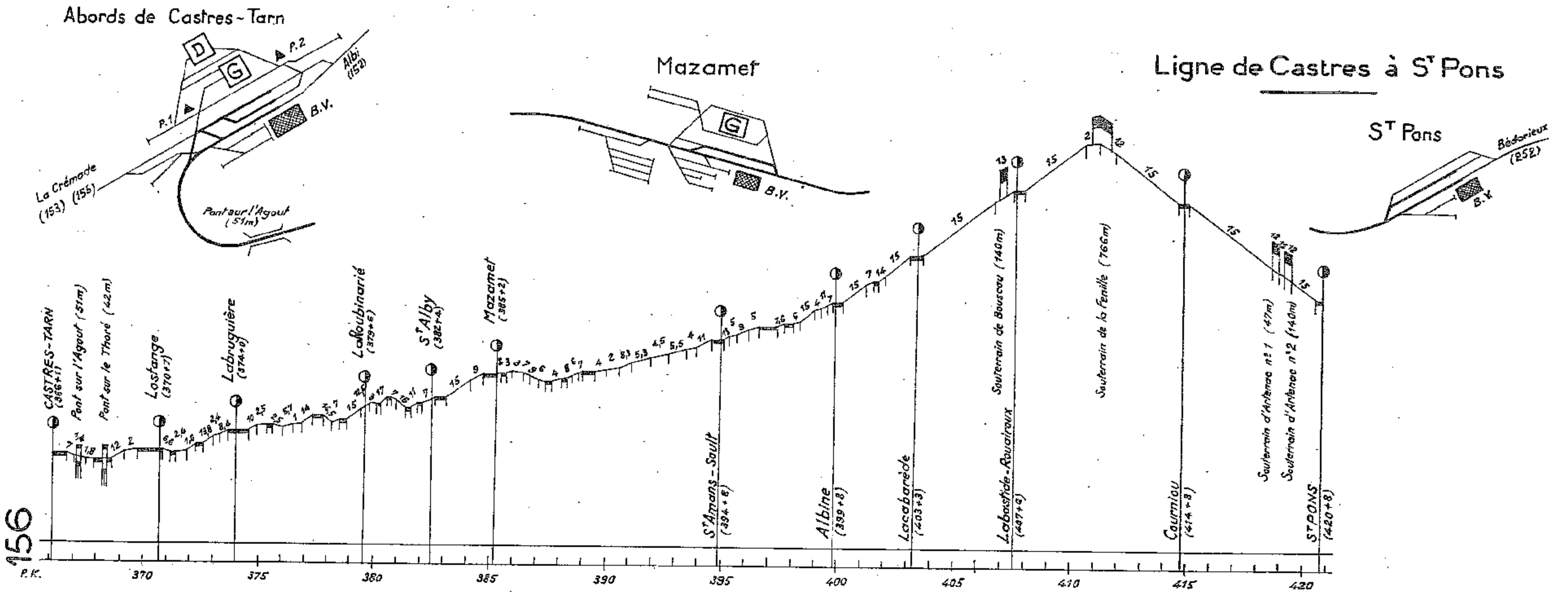

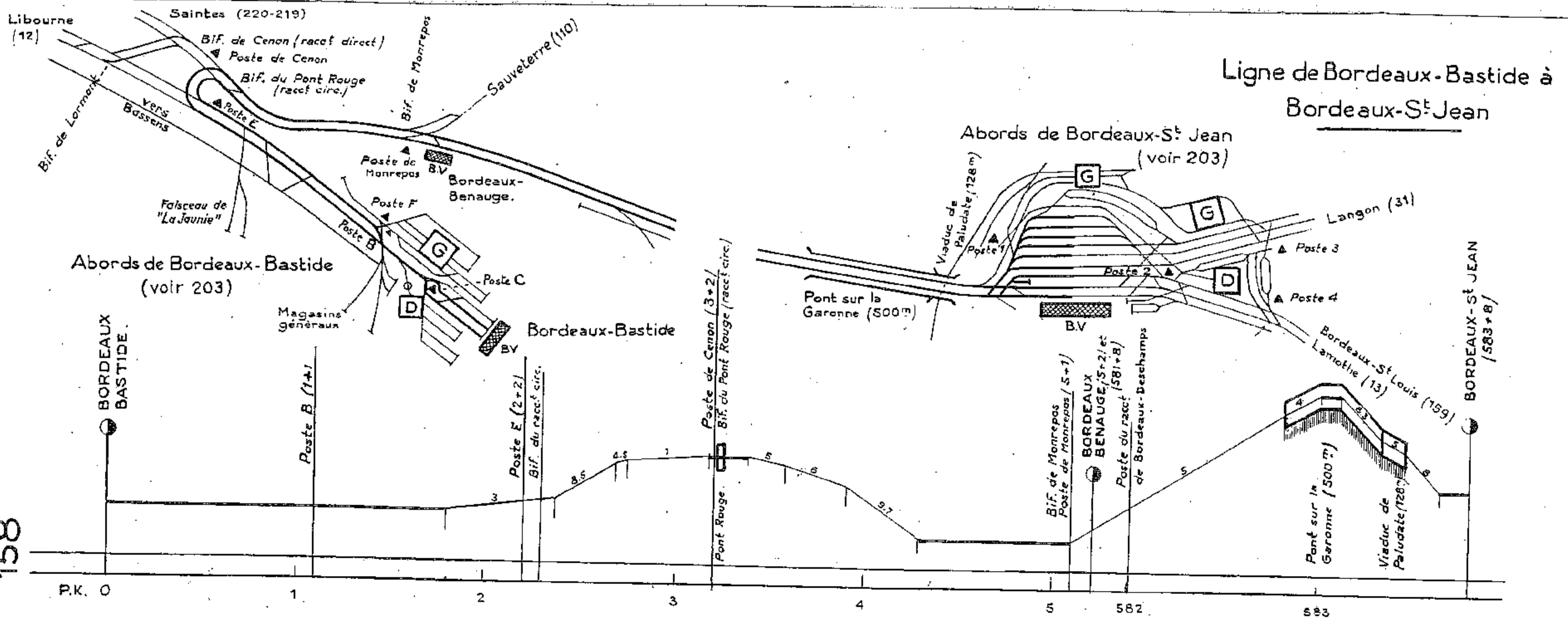
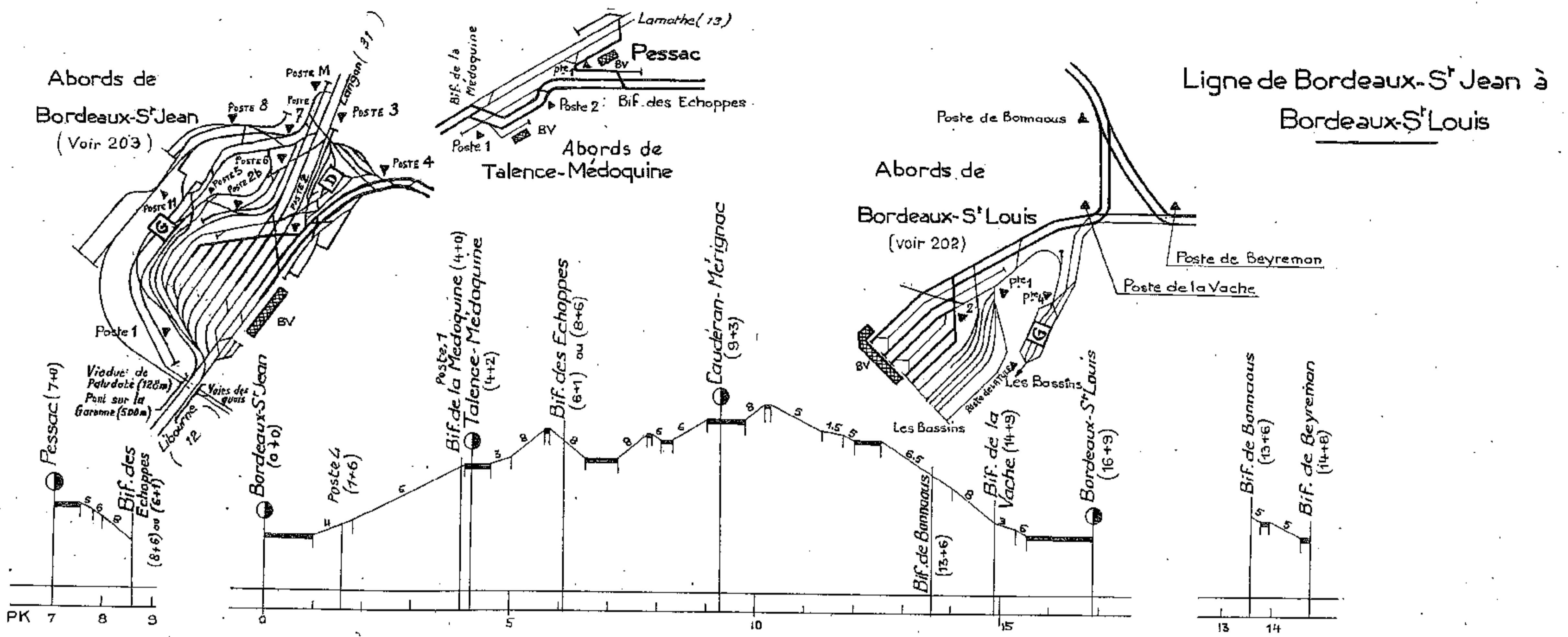

Abords de Bordeaux S^t. Louis (voir 202)

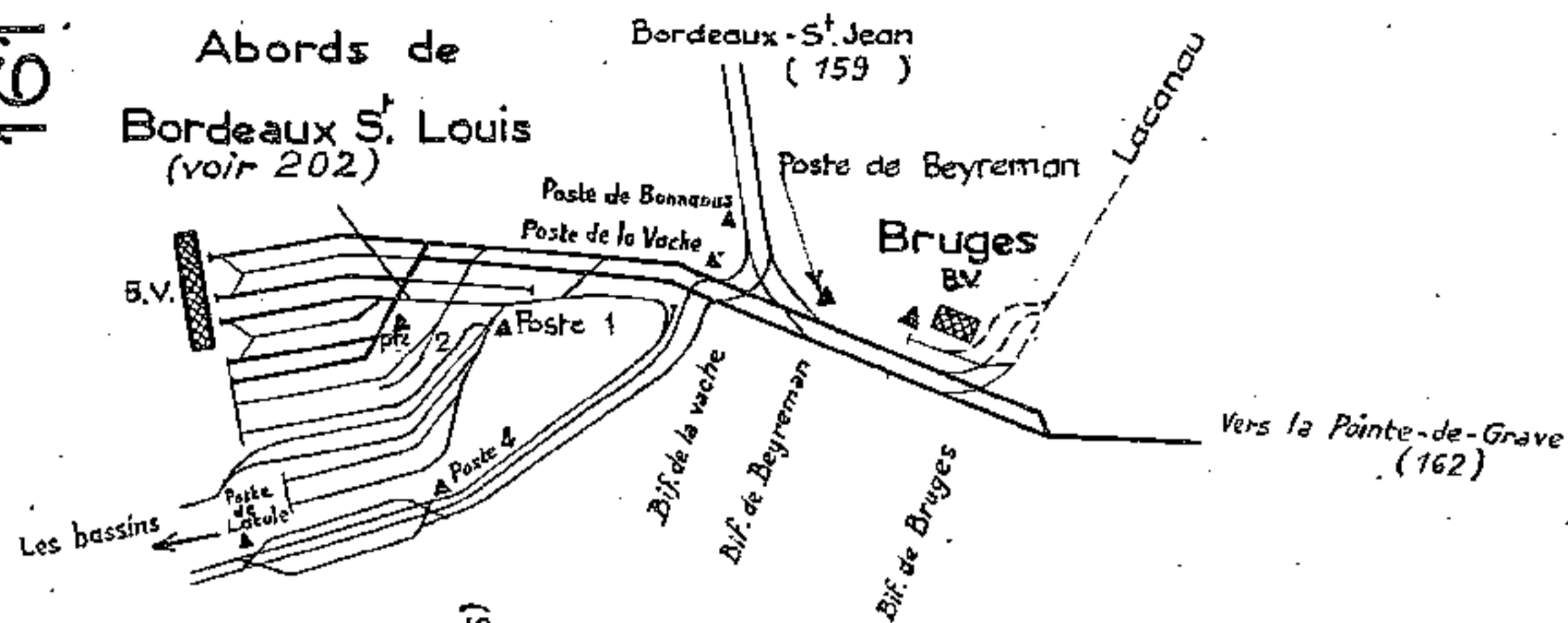

Ligne de Bordeaux-S^t.Louis à la Pointe-de-Grave

Section de Bordeaux-S^t.Louis à Pauillac

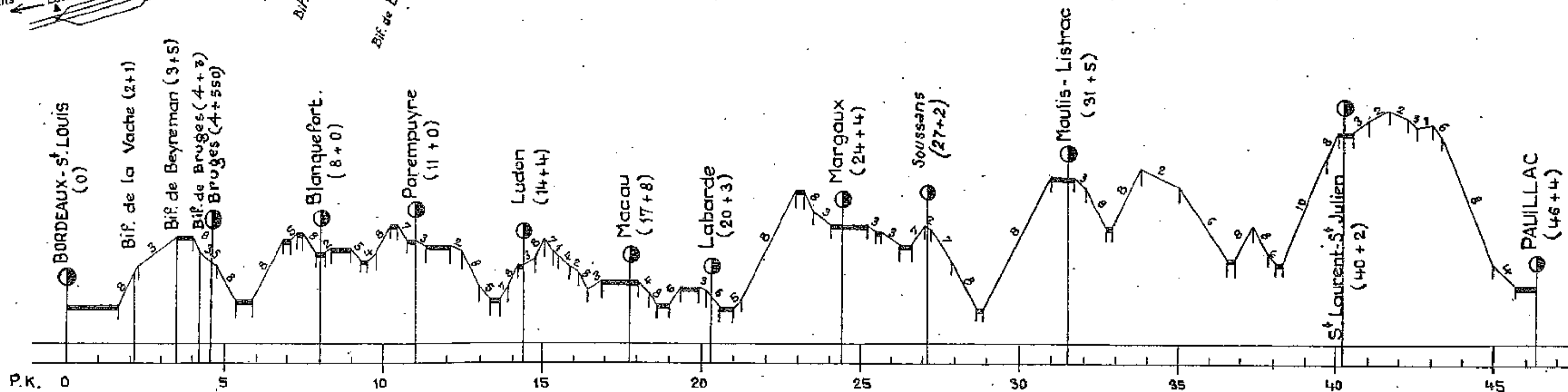

Abords de Bassens-Ville

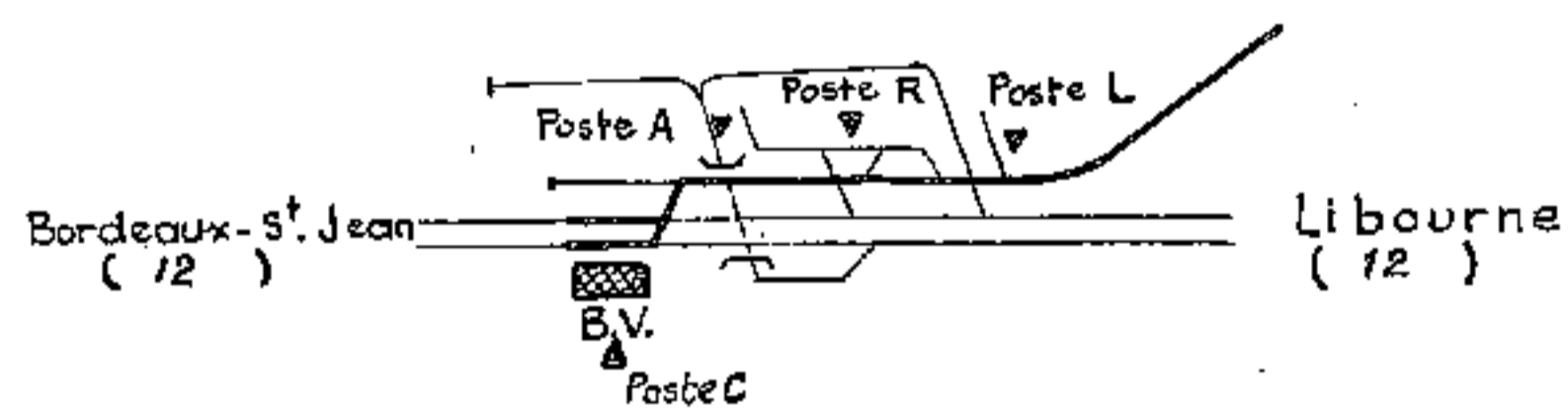

Ligne de Bassens-Ville au Bec d'Ambès

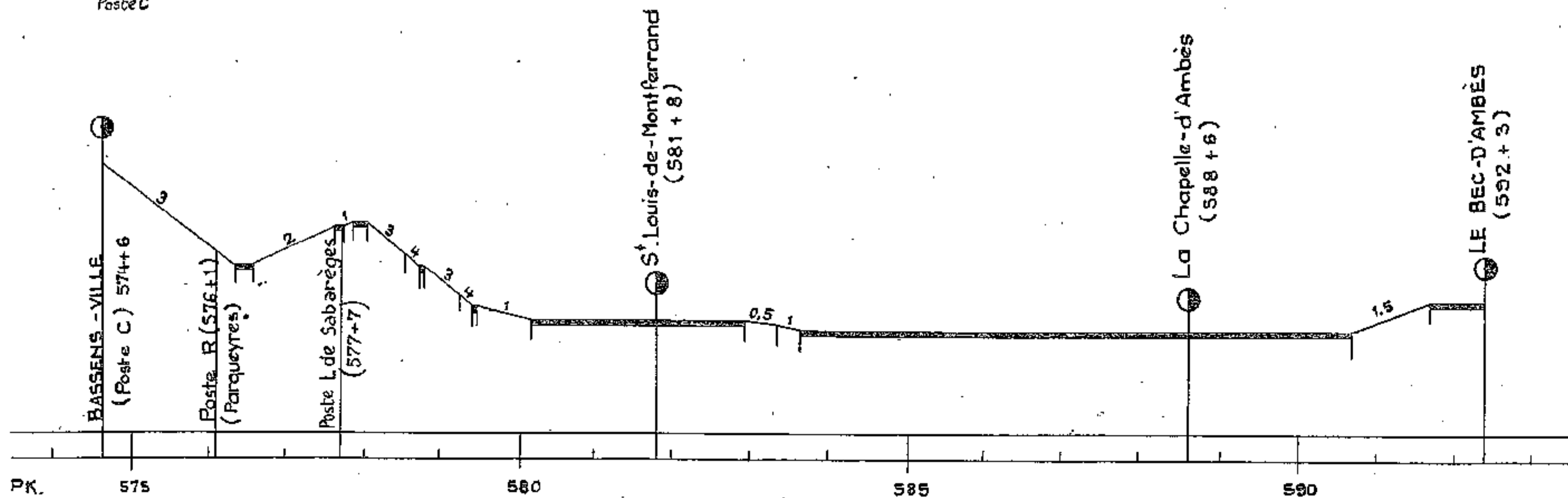

Abords de Marcenais

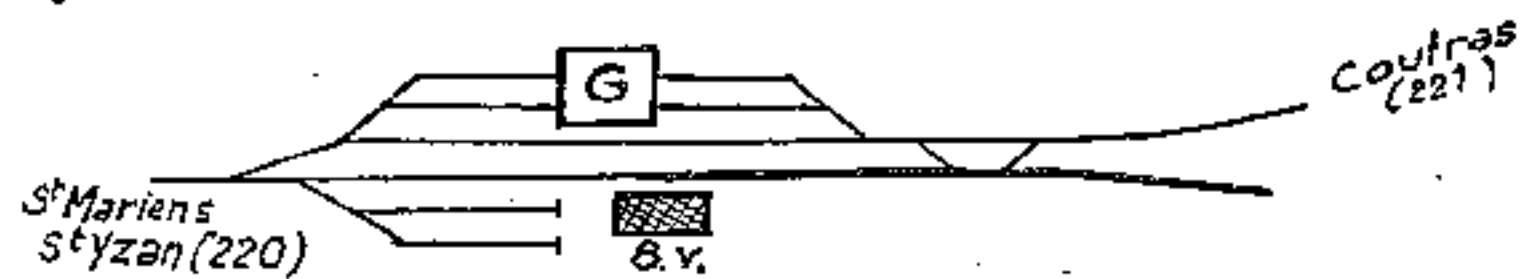

Ligne de Marcenais à Libourne

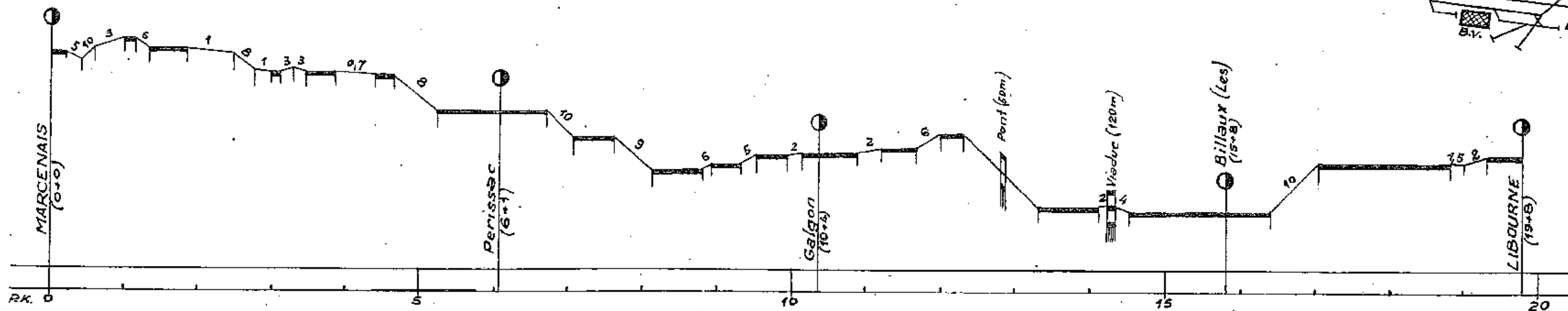

Abords de Libourne

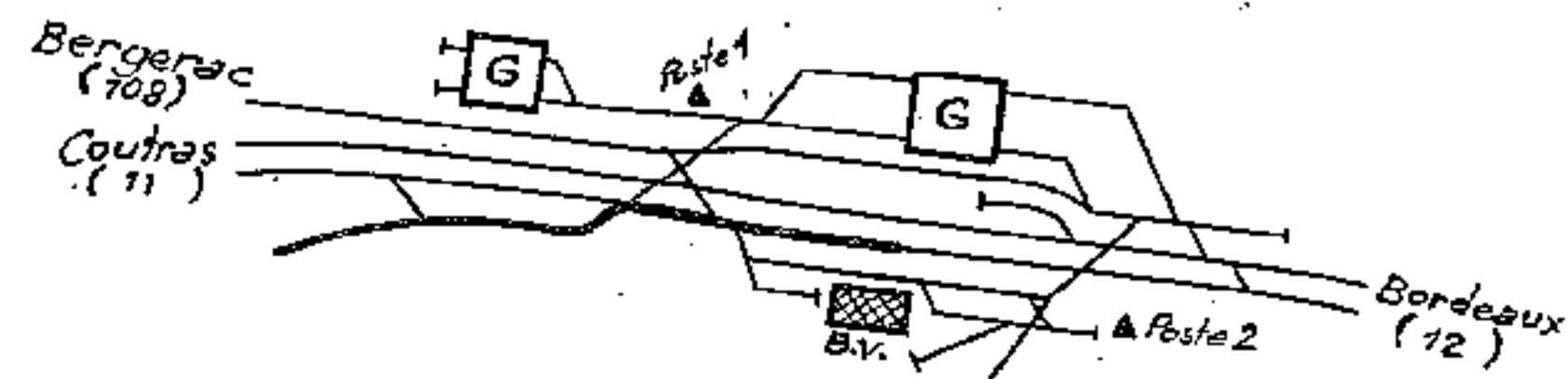

Abords de Leparre



Abords du Verdon

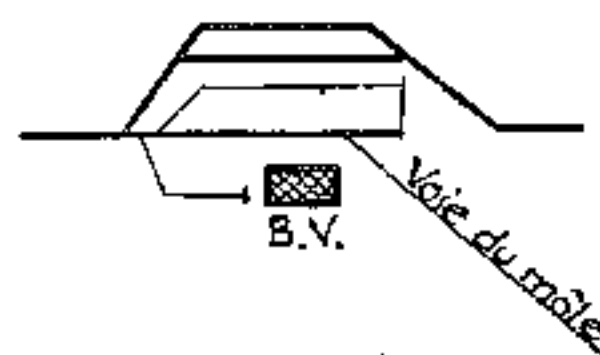

Ligne de Bordeaux-S't Louis à la Pointe-de-Grave

Section de Pauillac a la Pointe-de-Grave

Abords de la Pointe de Grave

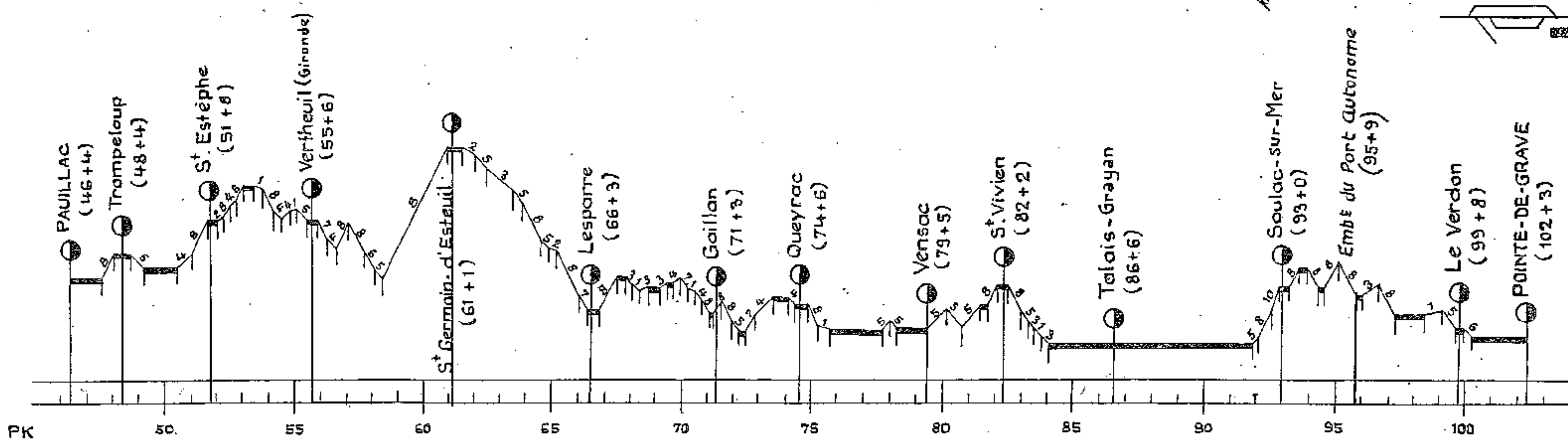
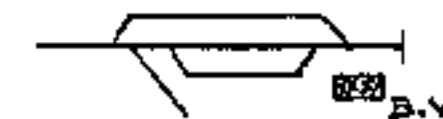

Ligne de Marmande à Mont-de-Marsan

Section de Marmande à Bourriot-Bergonce

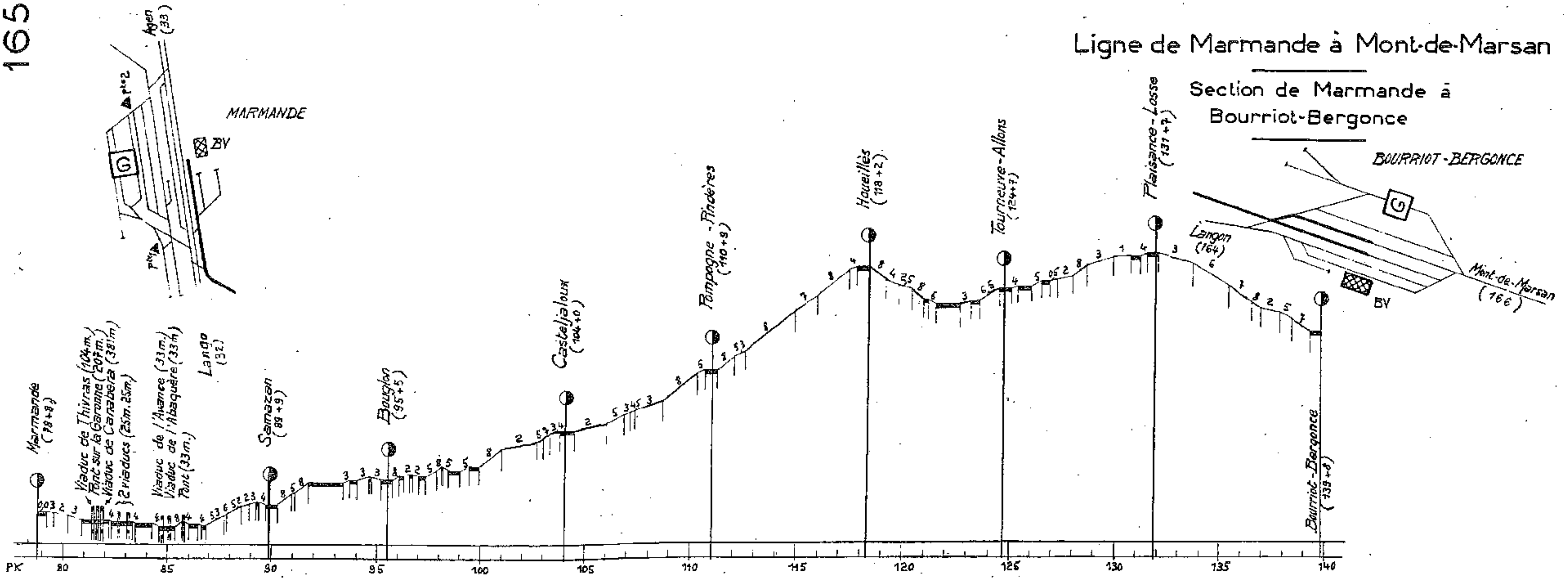

Abords de Bourriot-Bergonce

Ligne de Lango à Bourriot-Bergonce

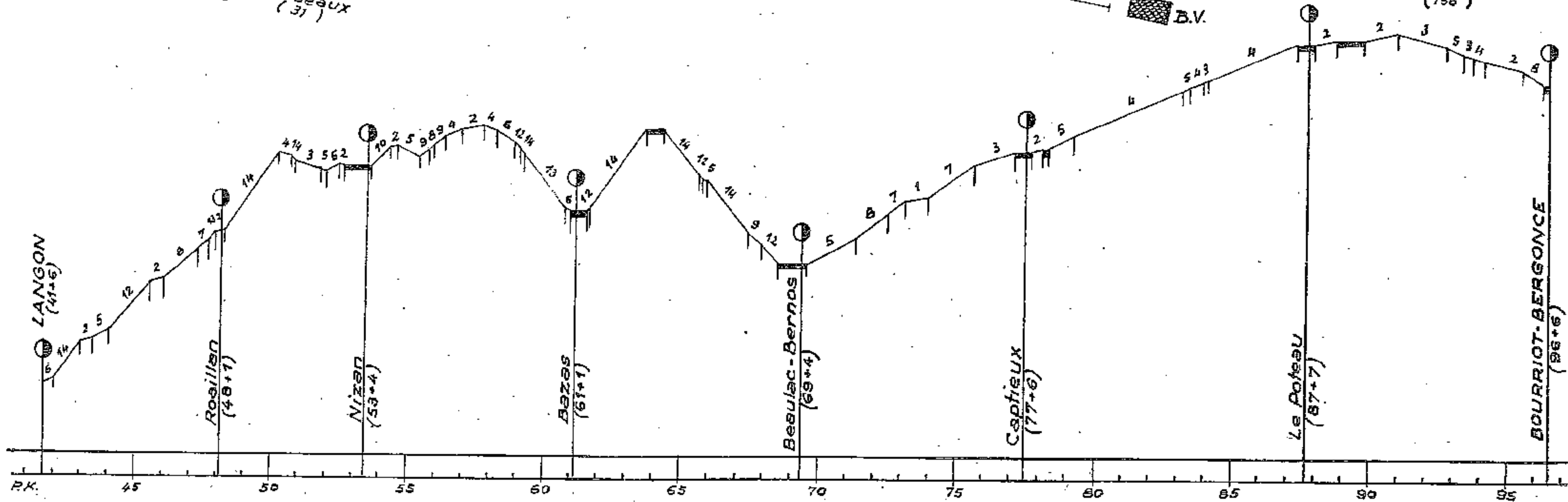
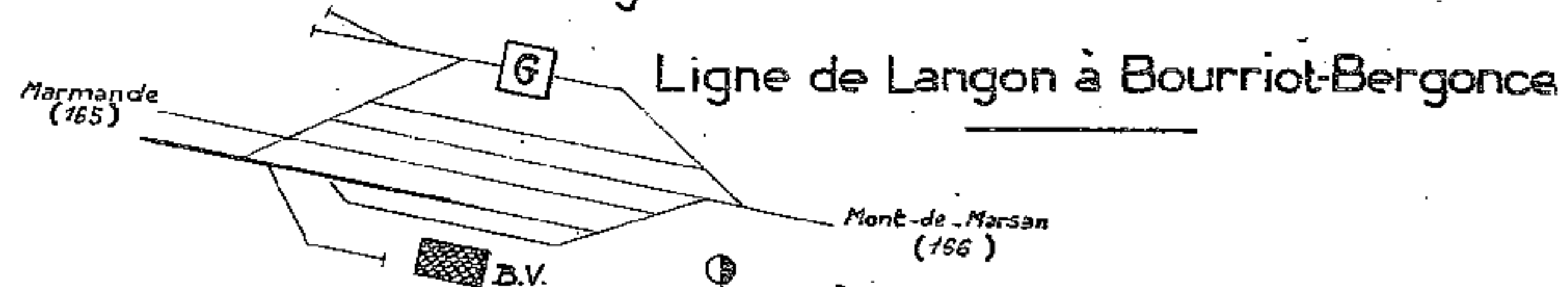
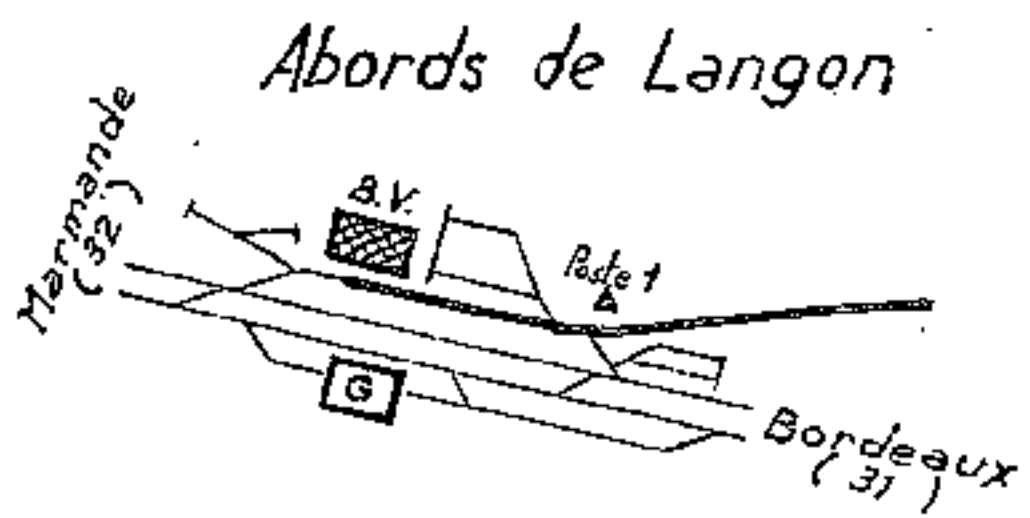

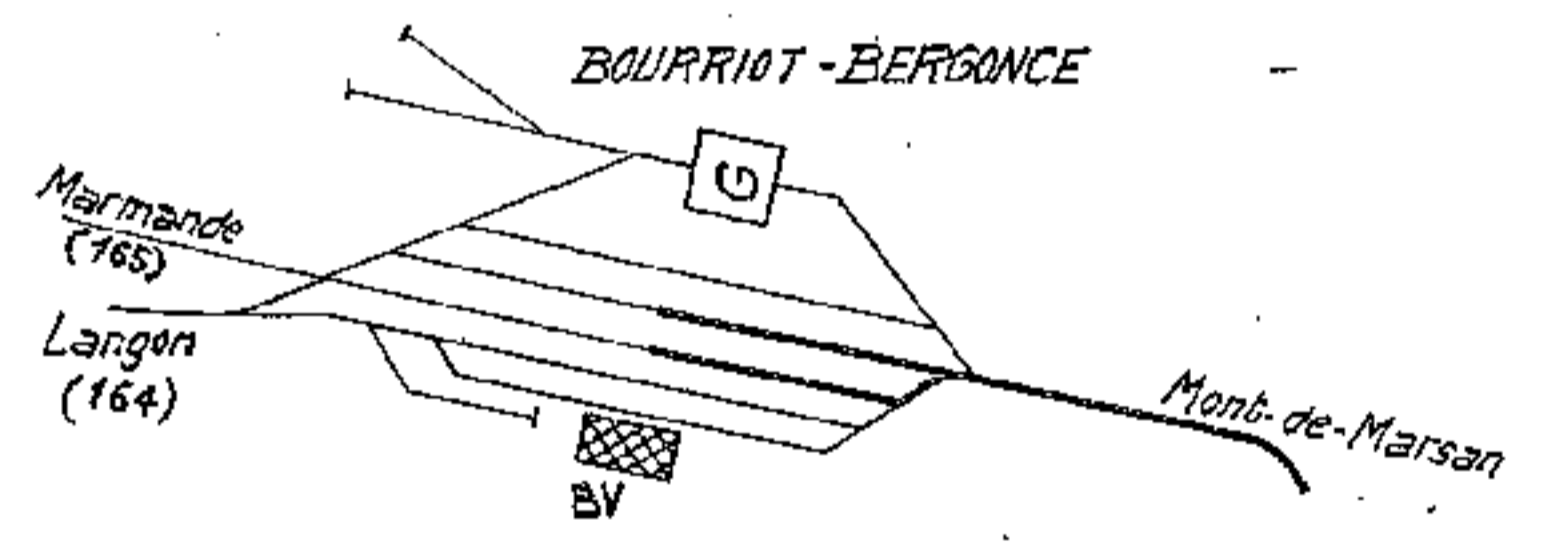
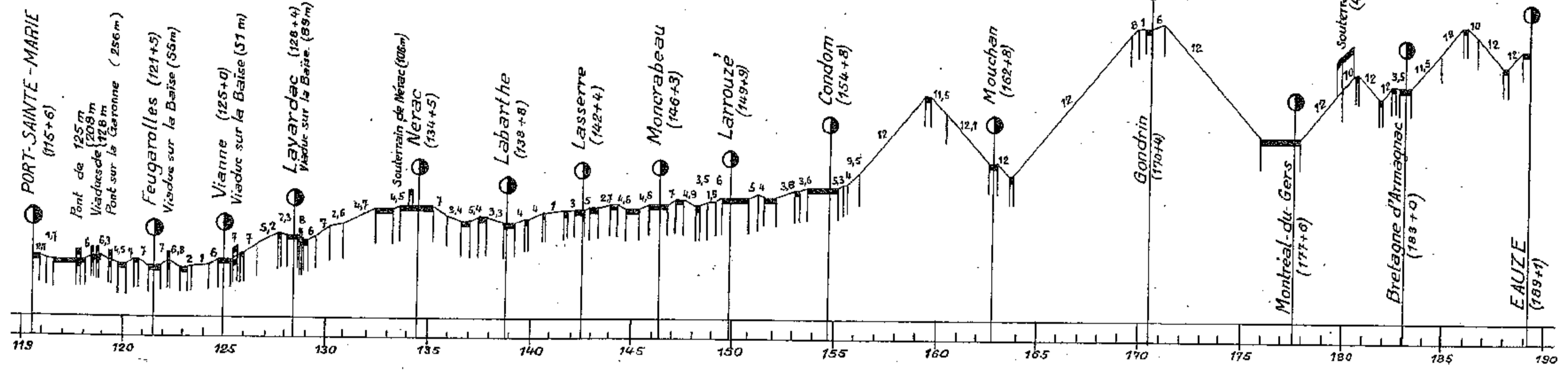
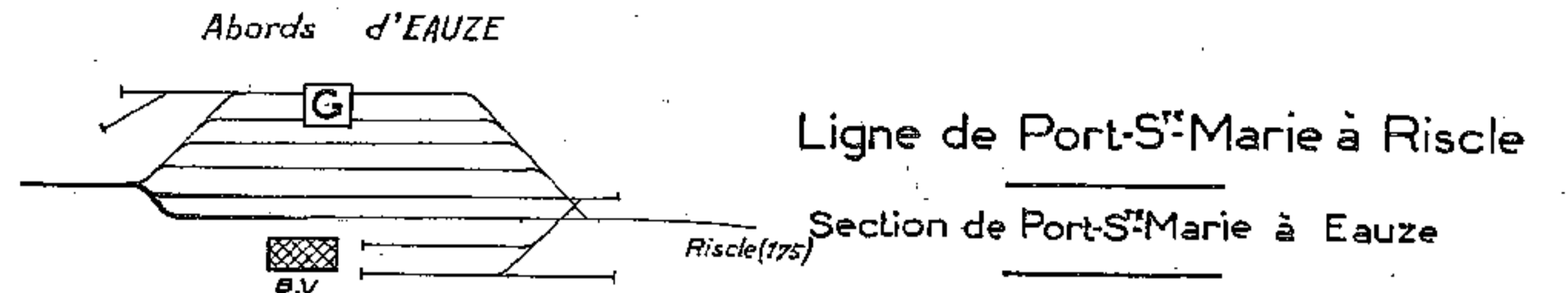
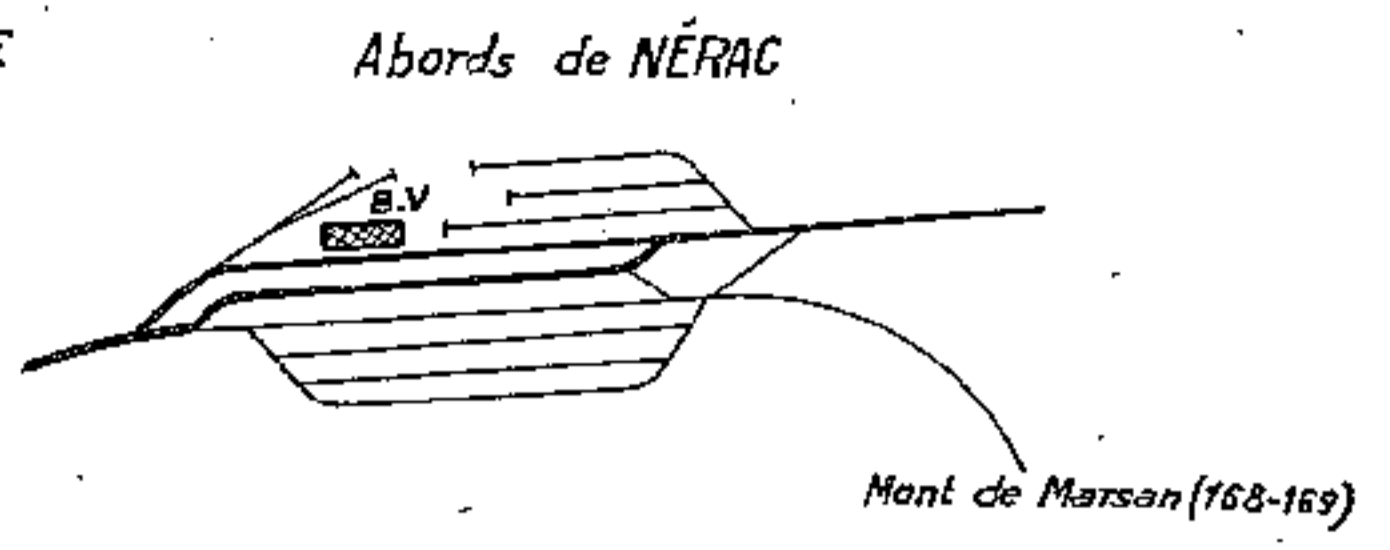
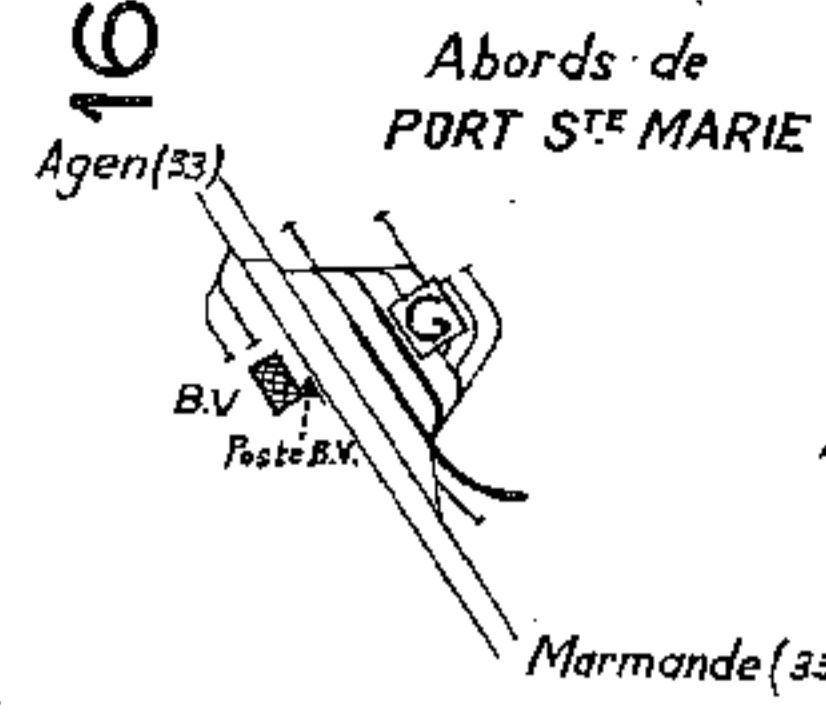

Ligne de Marmande à Mont-de-Marsan

Section de Bourriot Bergonce à Mont de Marsan

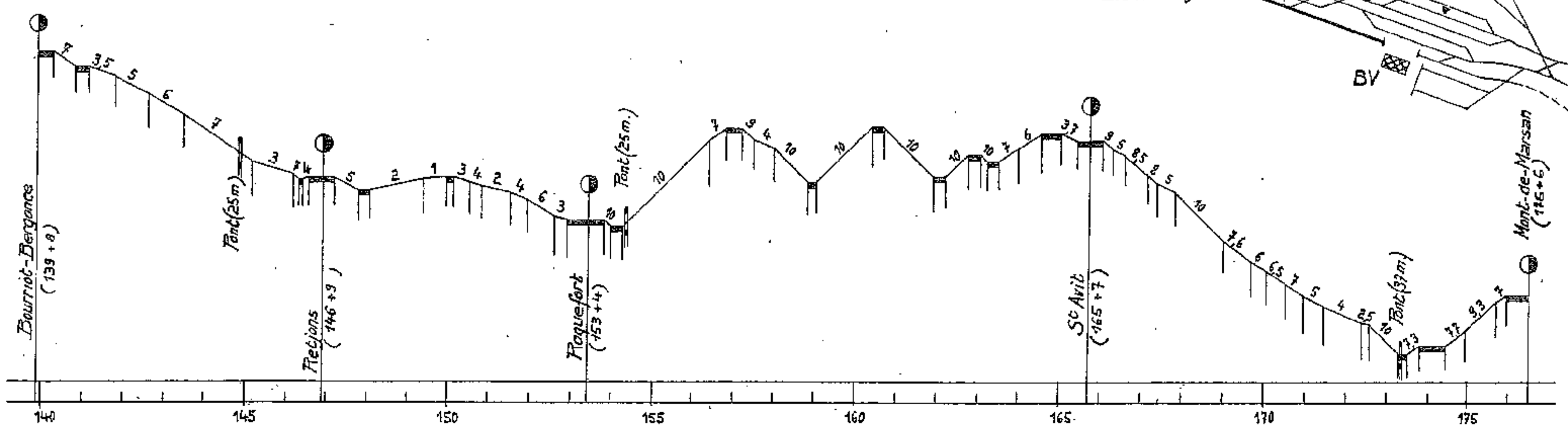
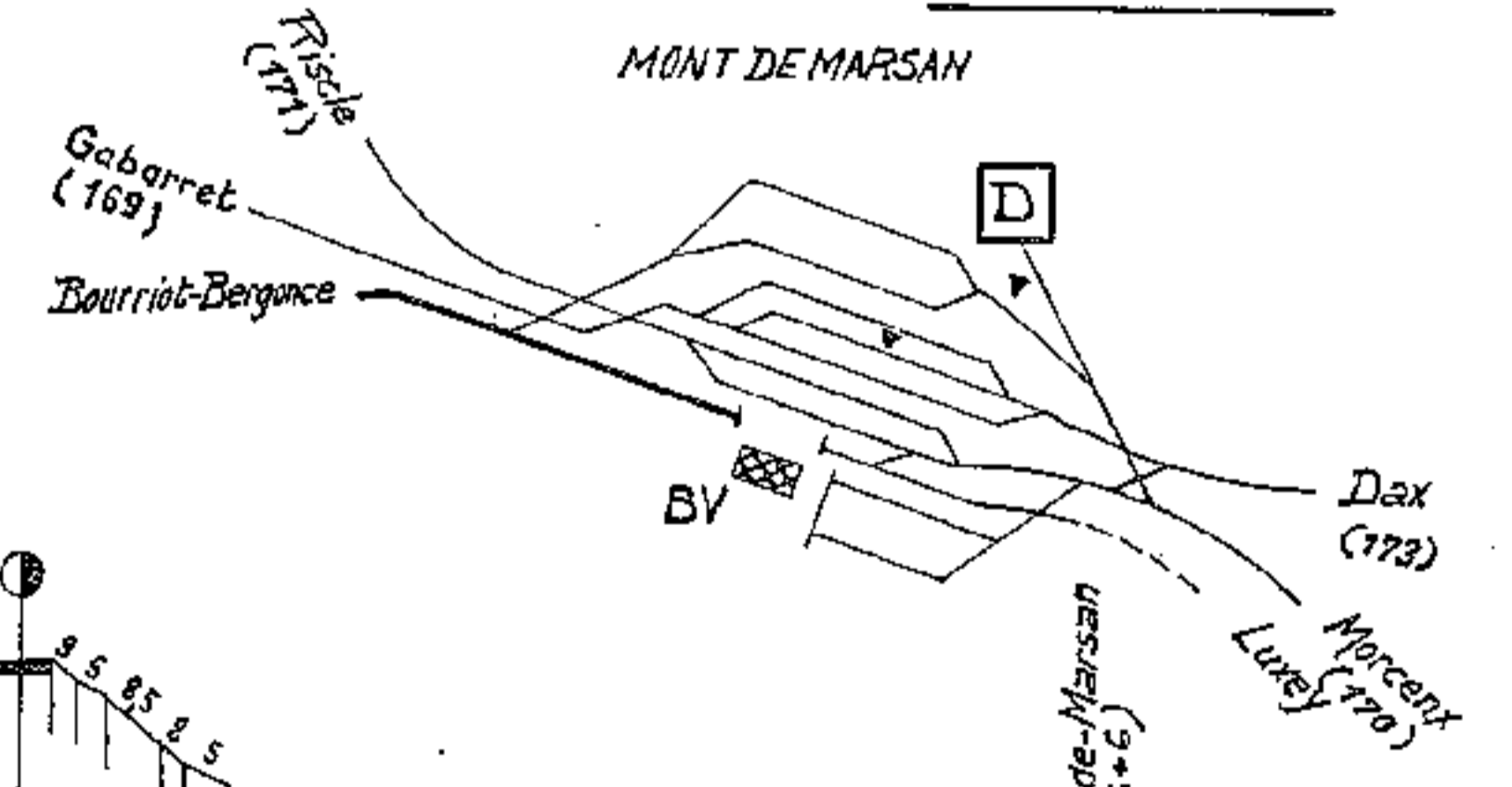

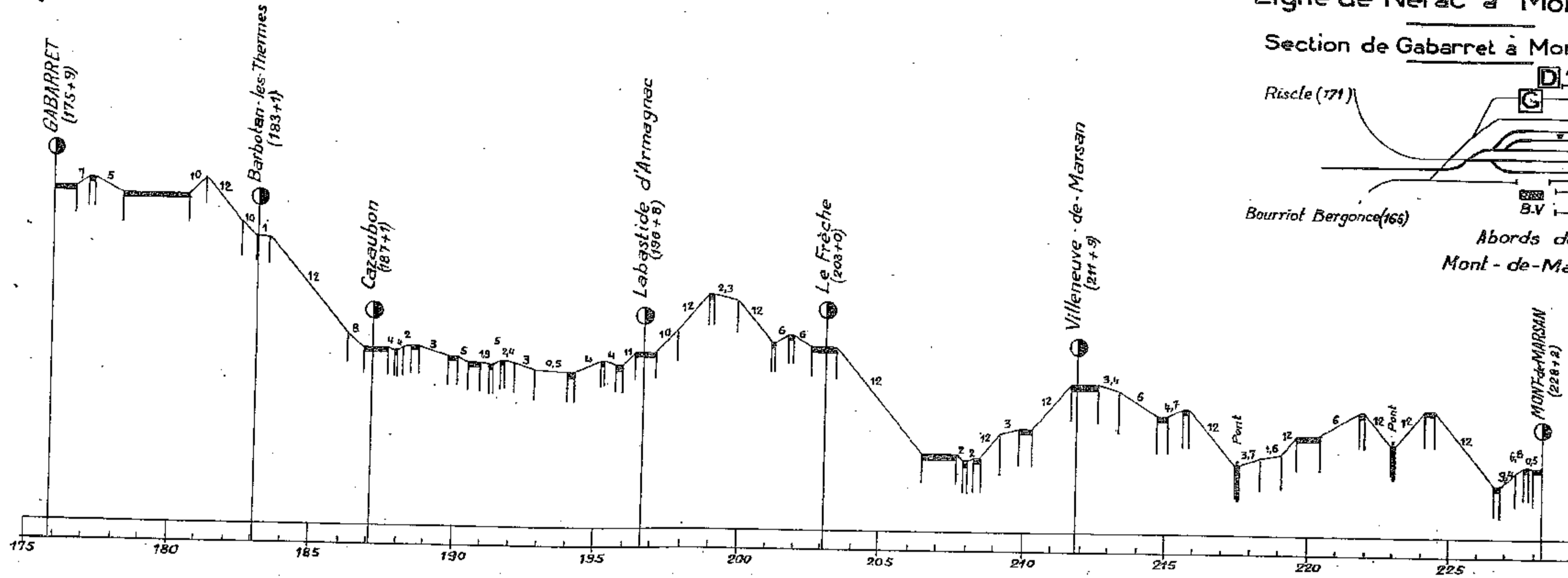

Ligne de Nérac à Mont-de-Marsan
Section de Gabarret à Mont-de-Marsan

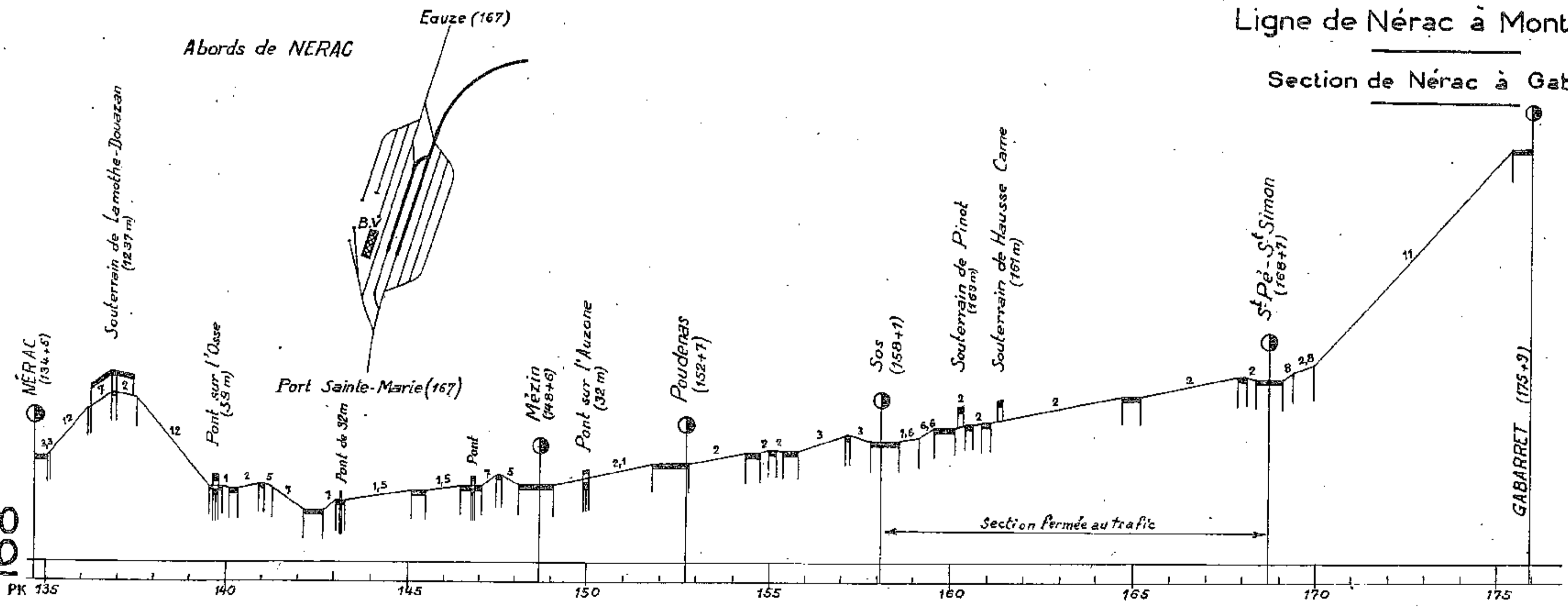
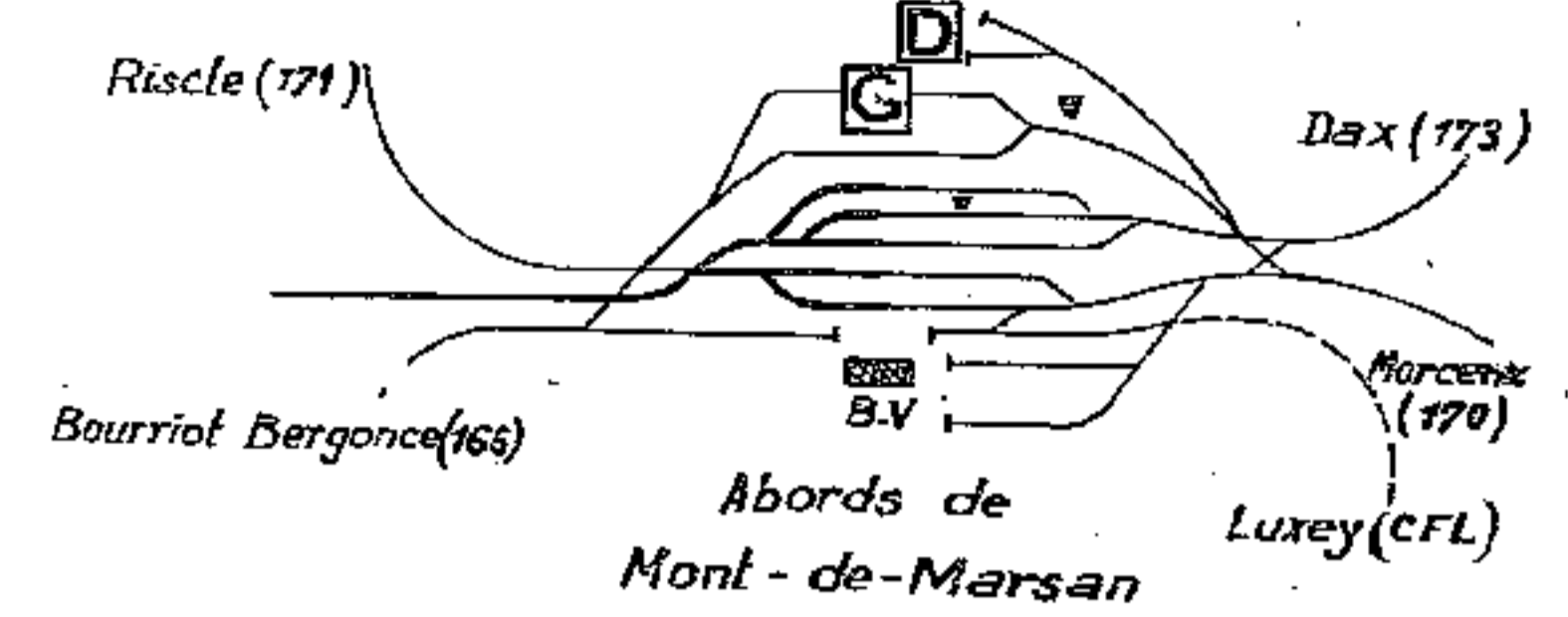

Ligne de Nérac à Mont-de-Marsan
Section de Nérac à Gabarret

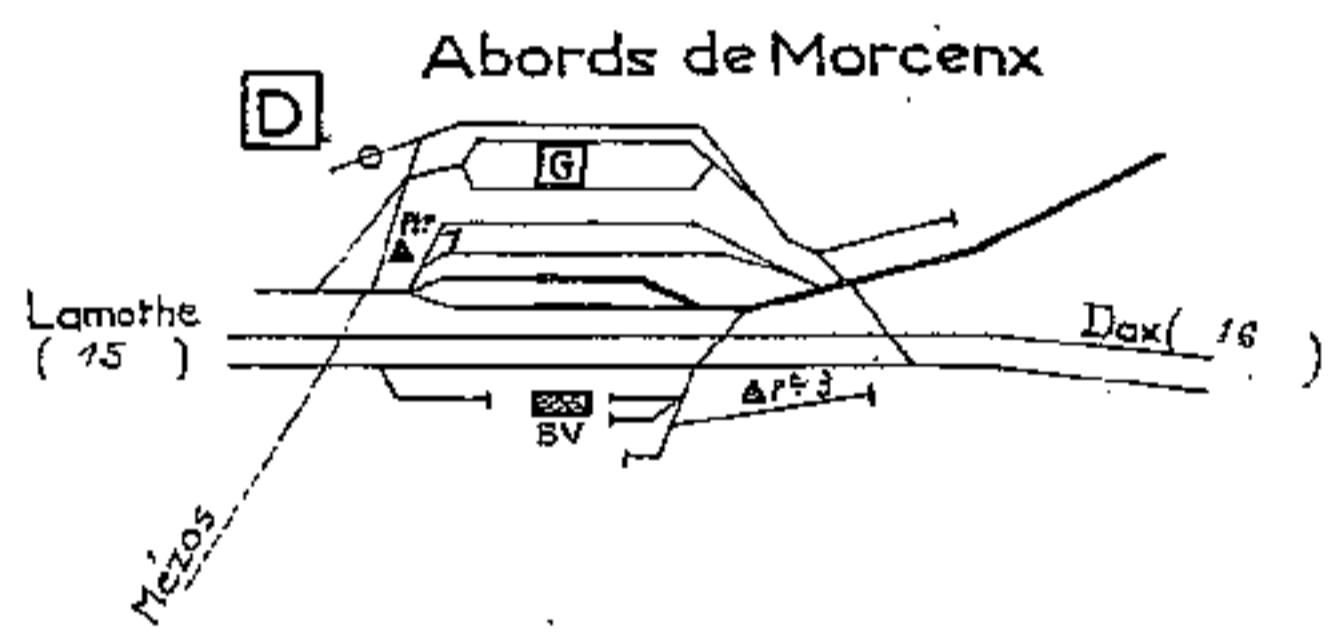
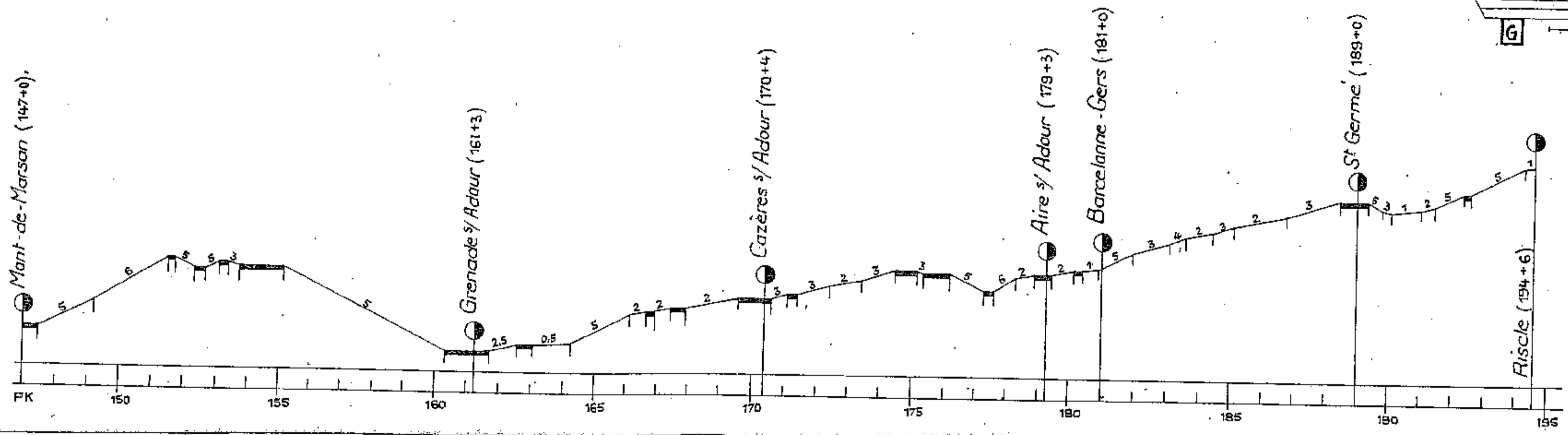
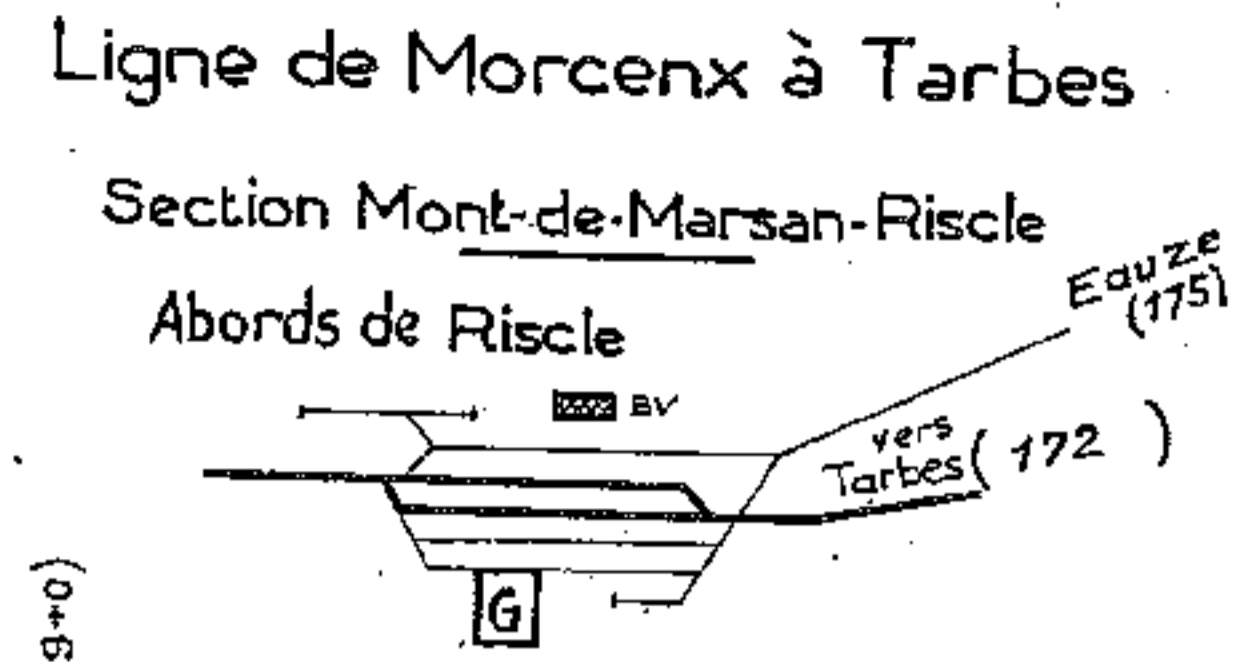
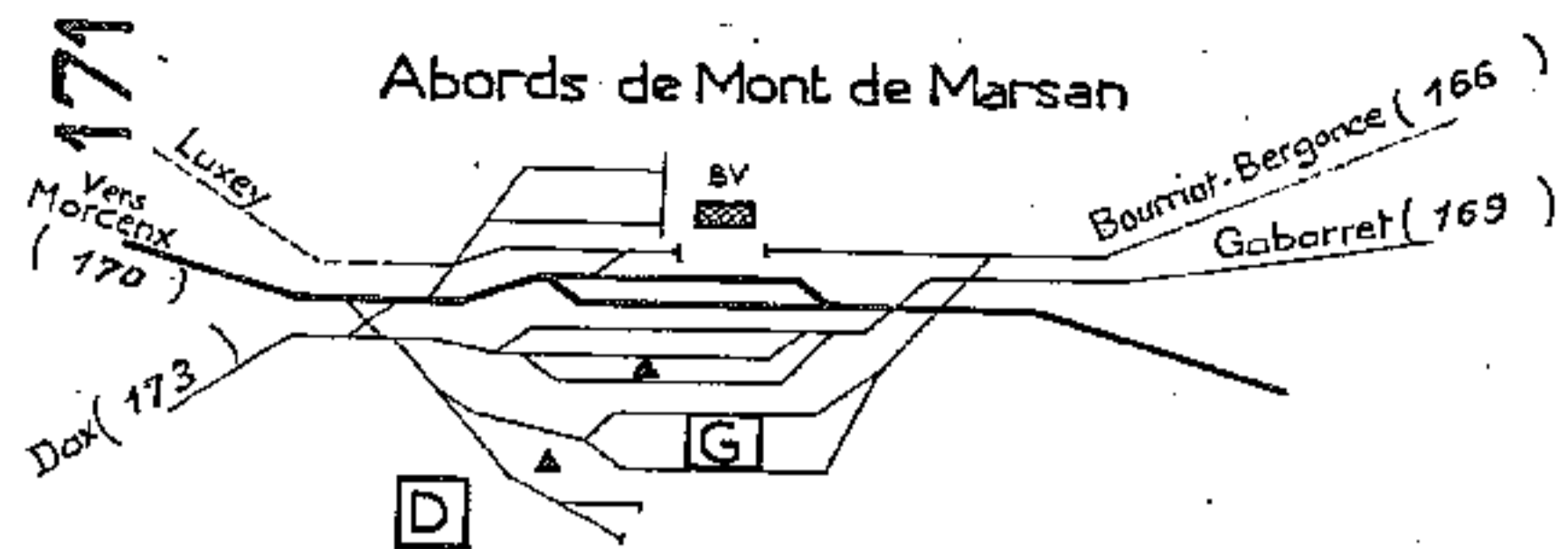

Ligne de Morcenx à Tarbes

Section Morcenx-Mont-de-Marsan

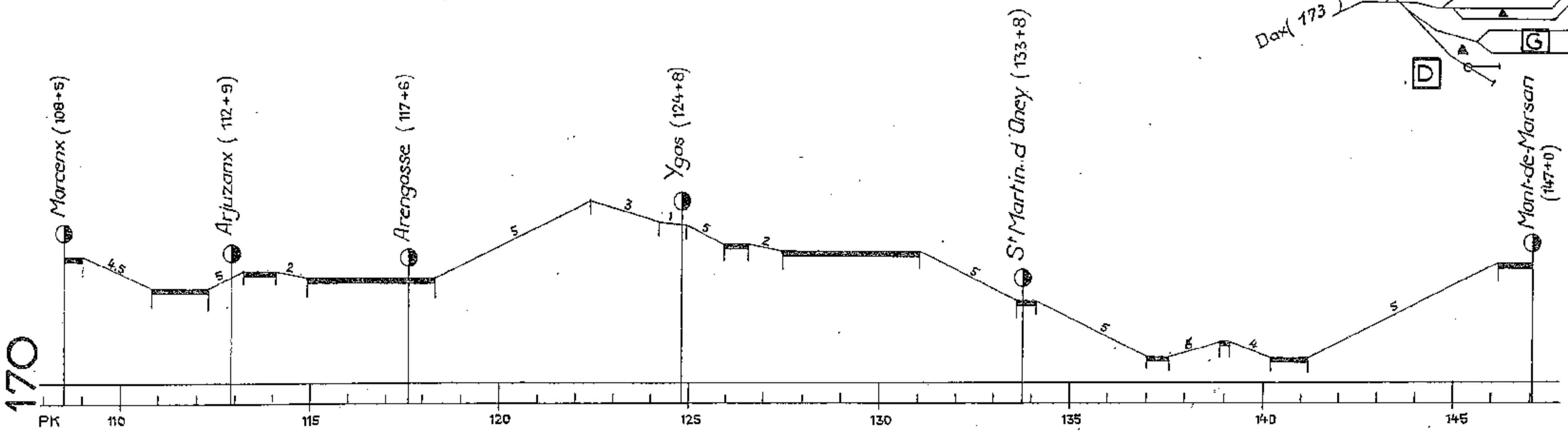
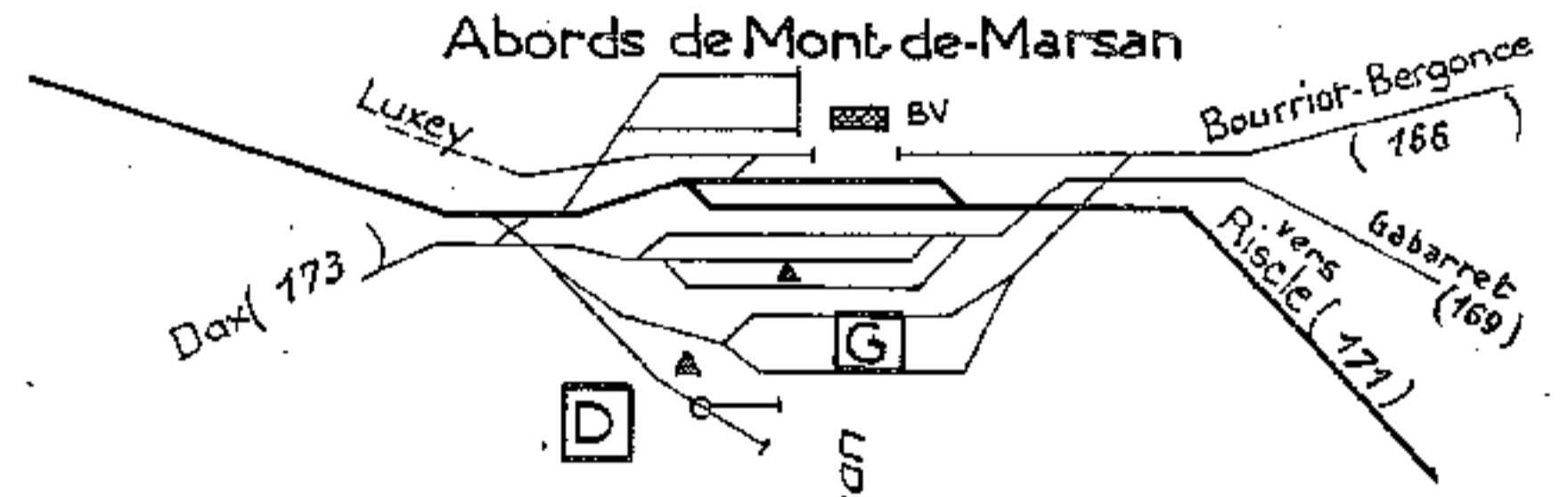

Ligne de Dax à Mont-de-Marsan

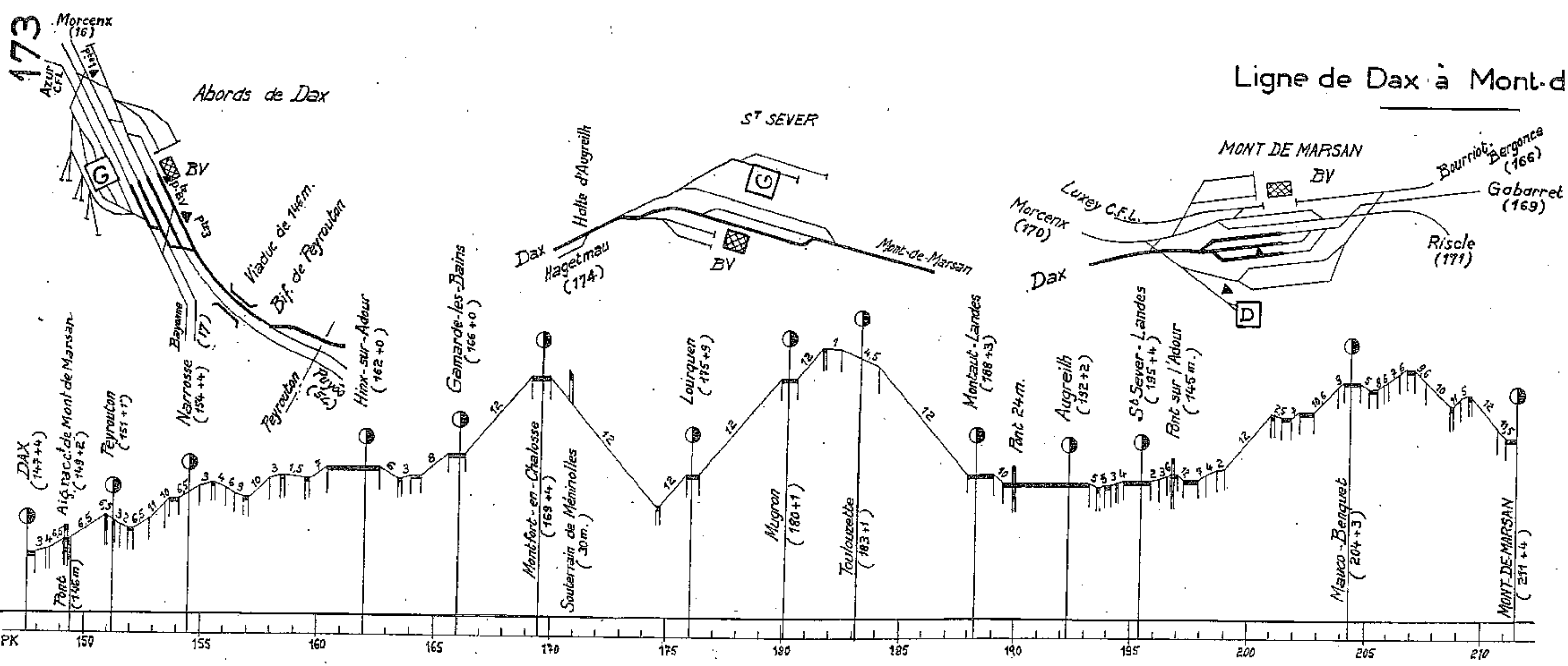

Abords de Riscle

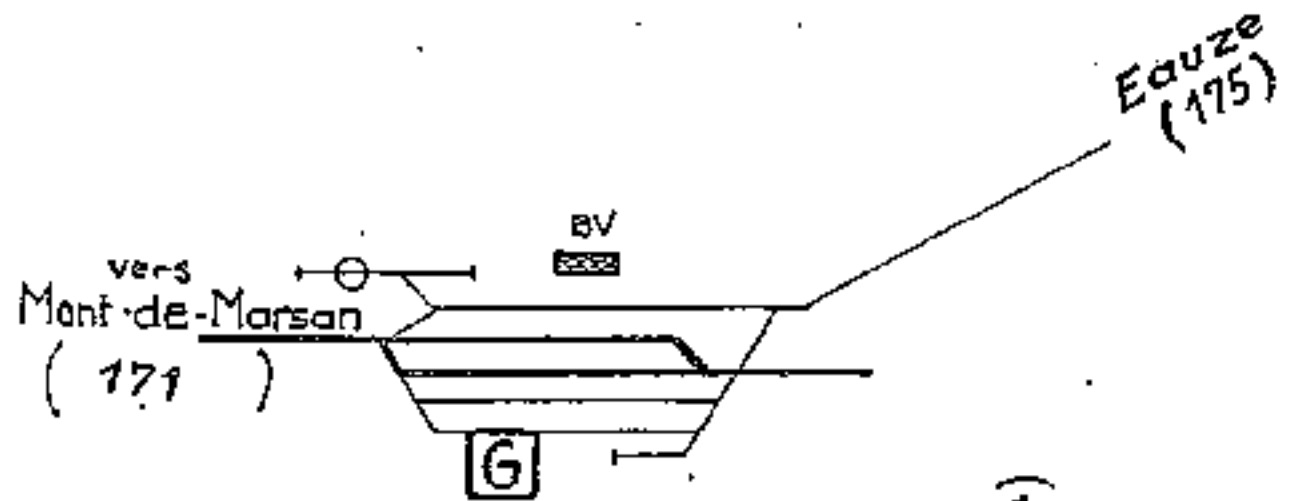

Abords de Vic-Bigorre



Ligne de Morcenx à Tarbes

Section Riscle-Tarbes

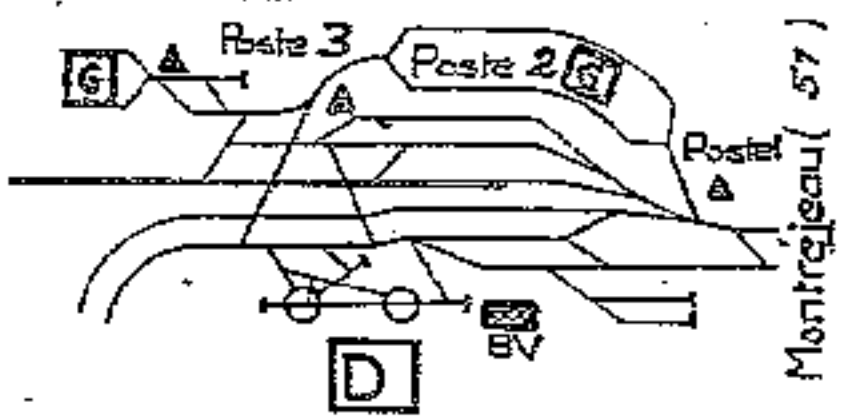
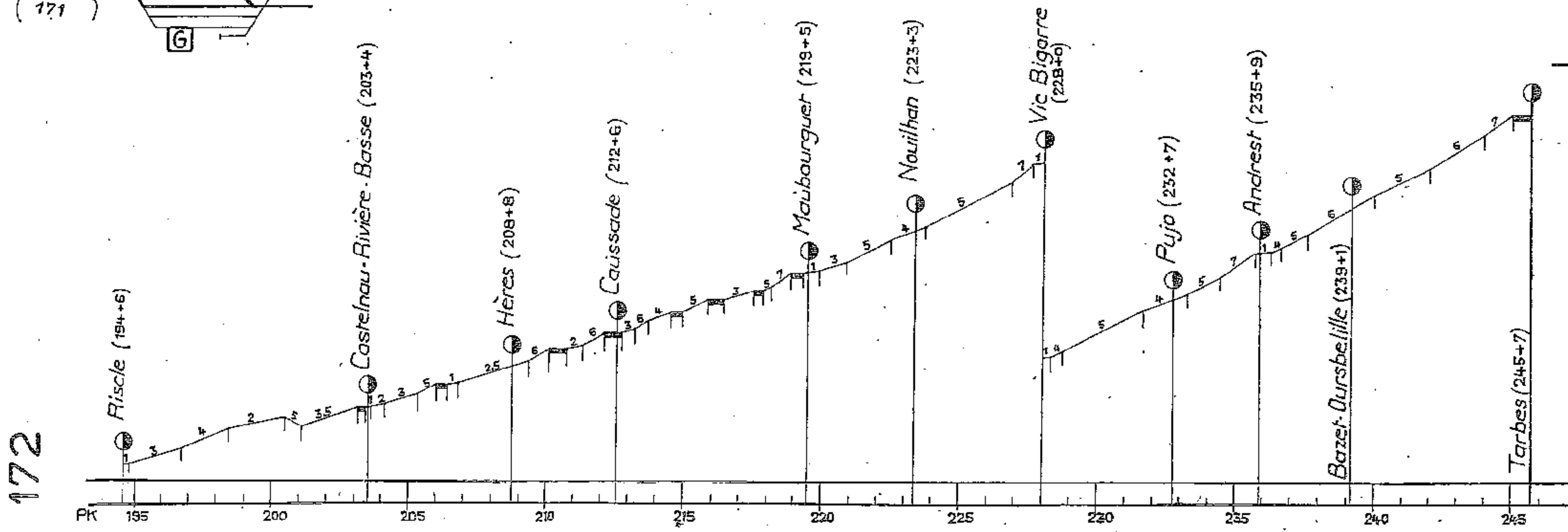

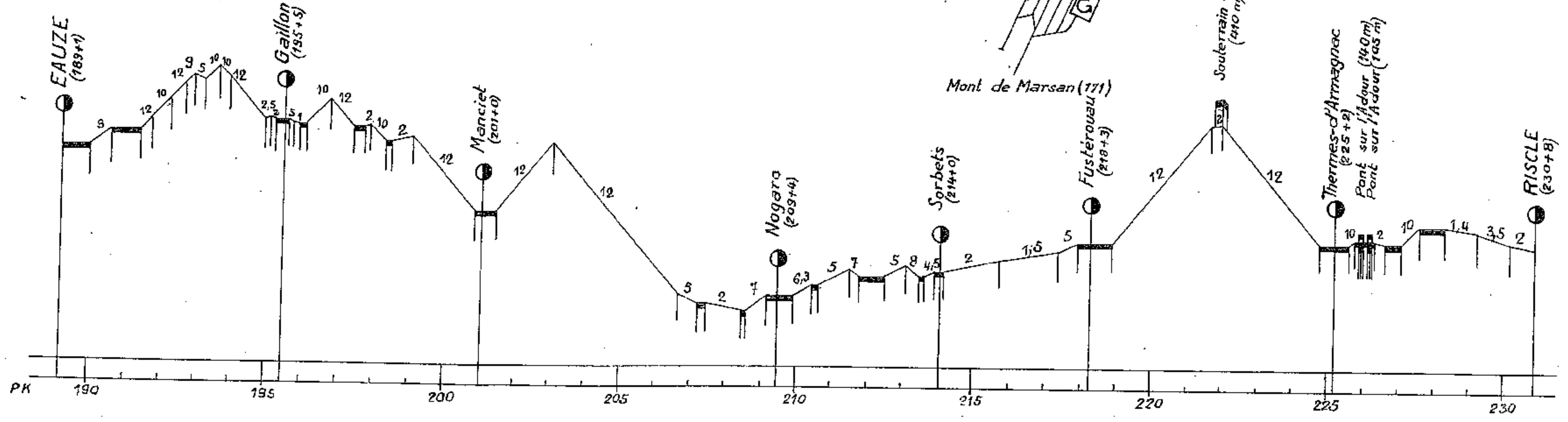
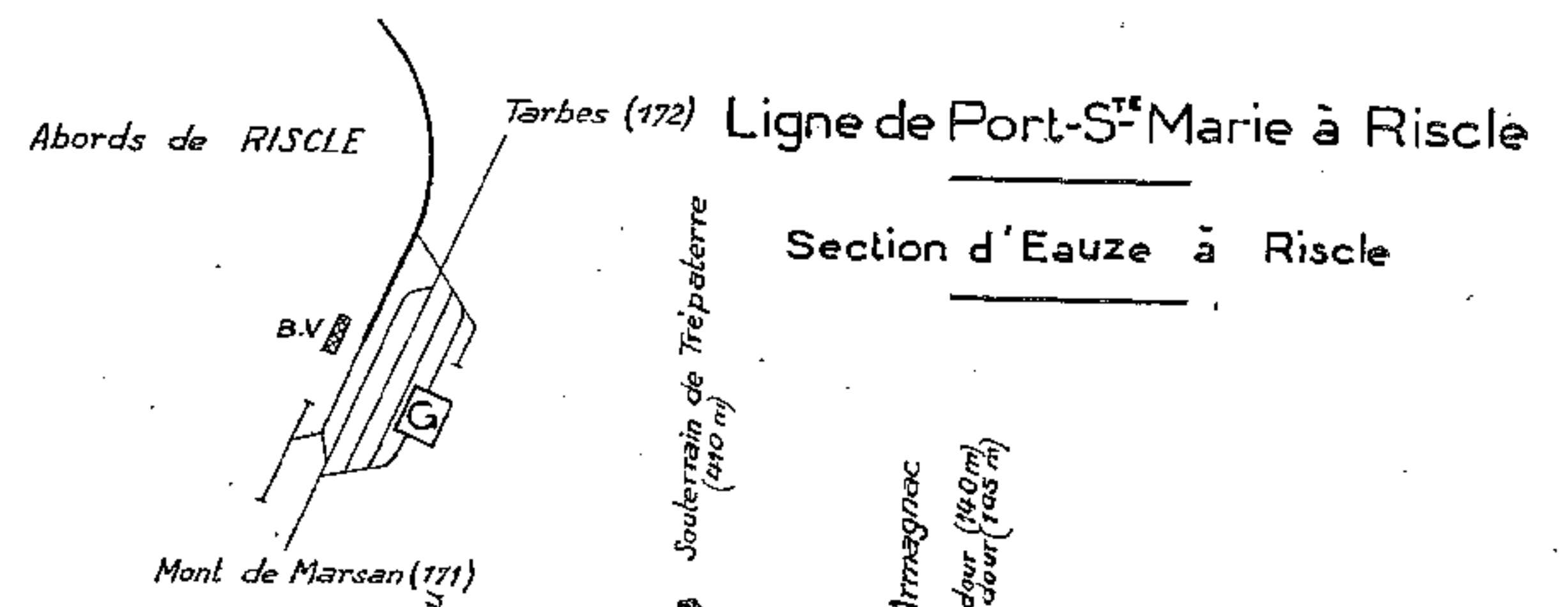
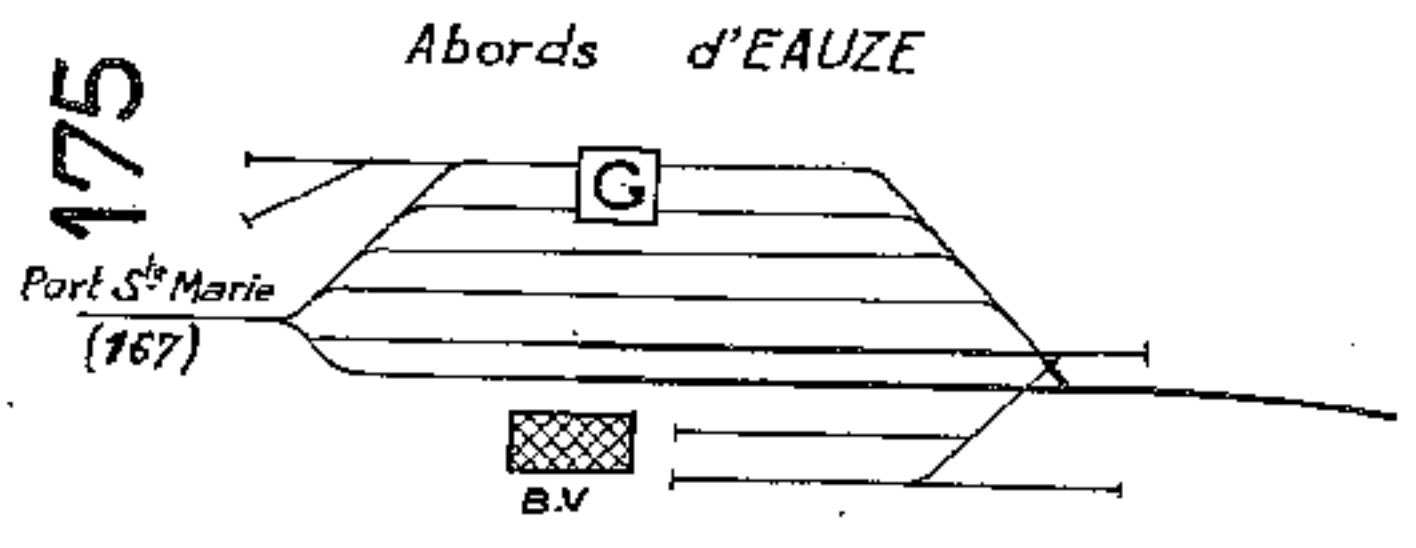

Ligne de S^t Sever à Hagetmau

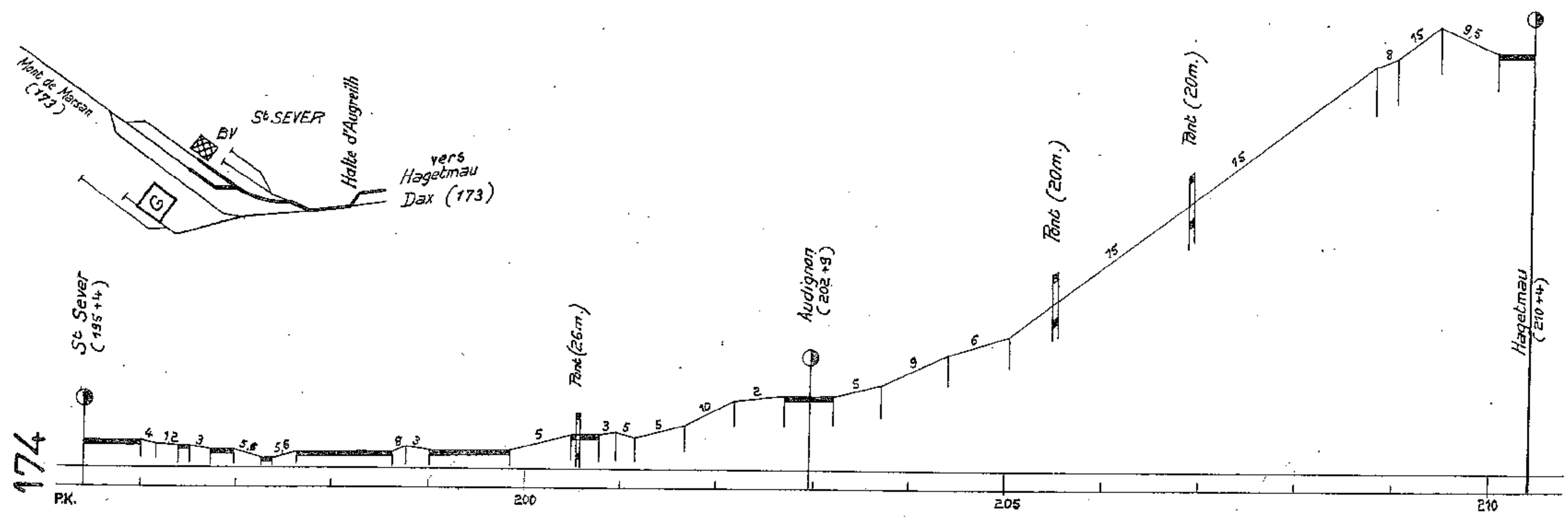

AUCH

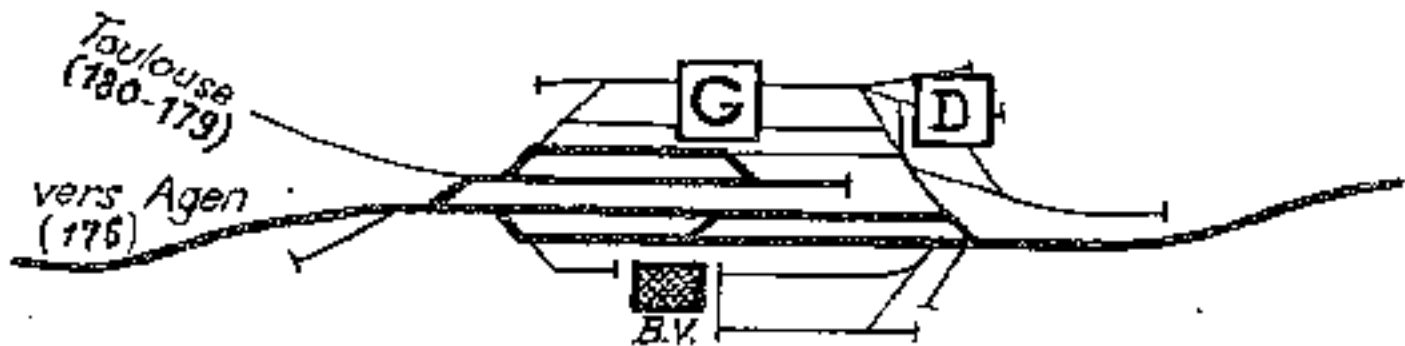

Ligne d'Agen à Vic-Bigorre

Section d'Auch à Vic-Bigorre

VIC-BIGORRE

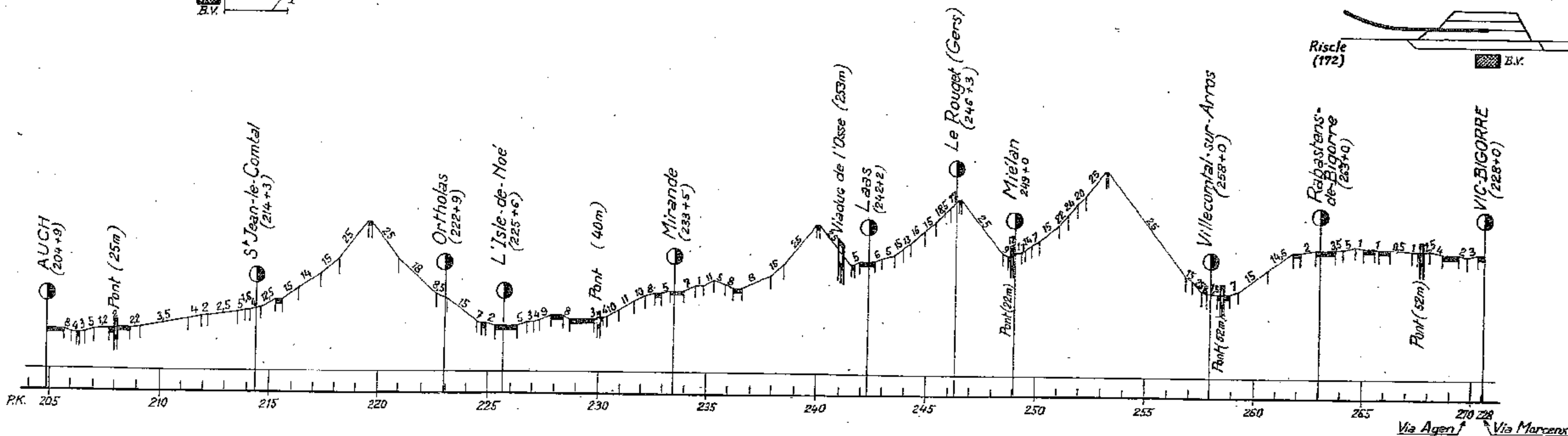

AGEN

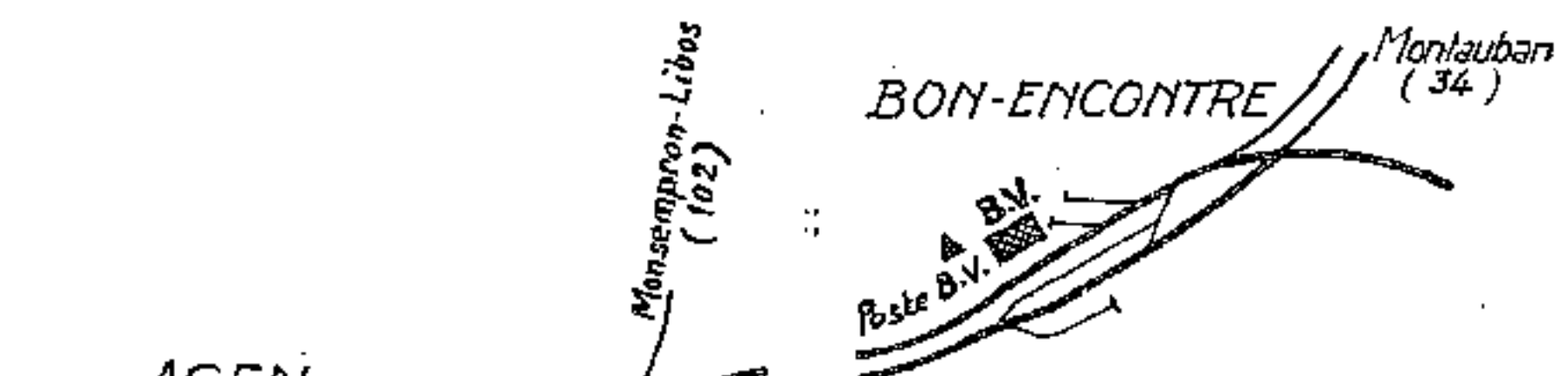

Ligne d'Agen à Vic-Bigorre

Section d'Agen à Auch

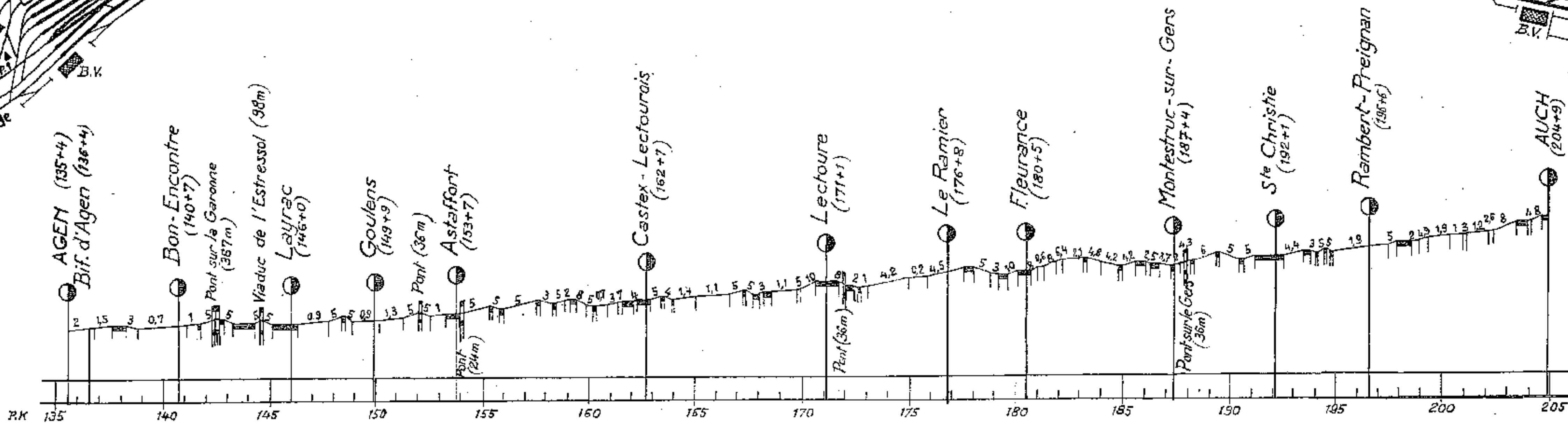
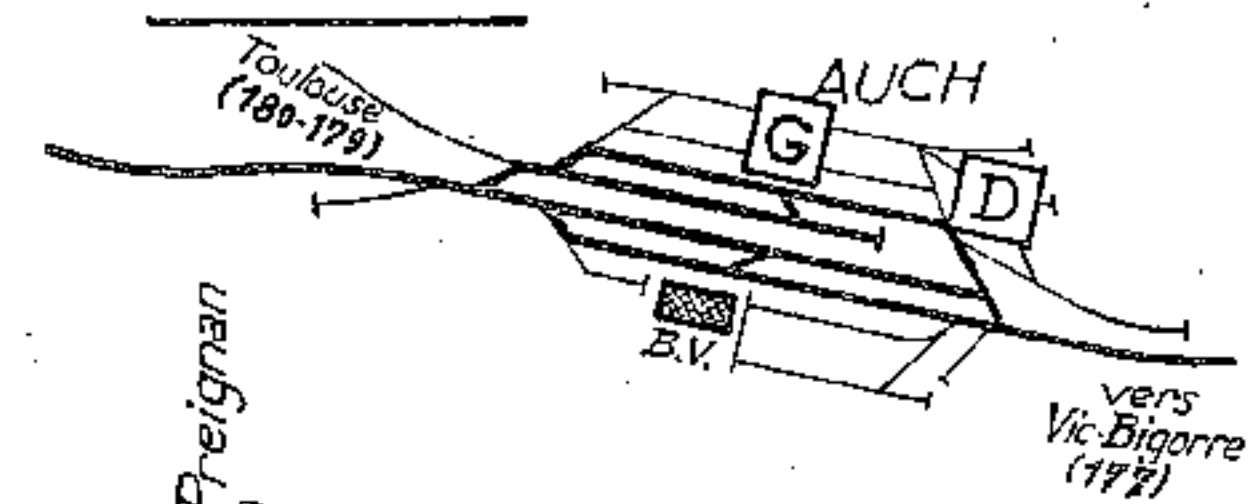

Ligne de Toulouse à Auch
Section de Toulouse à l'Isle-Jourdain

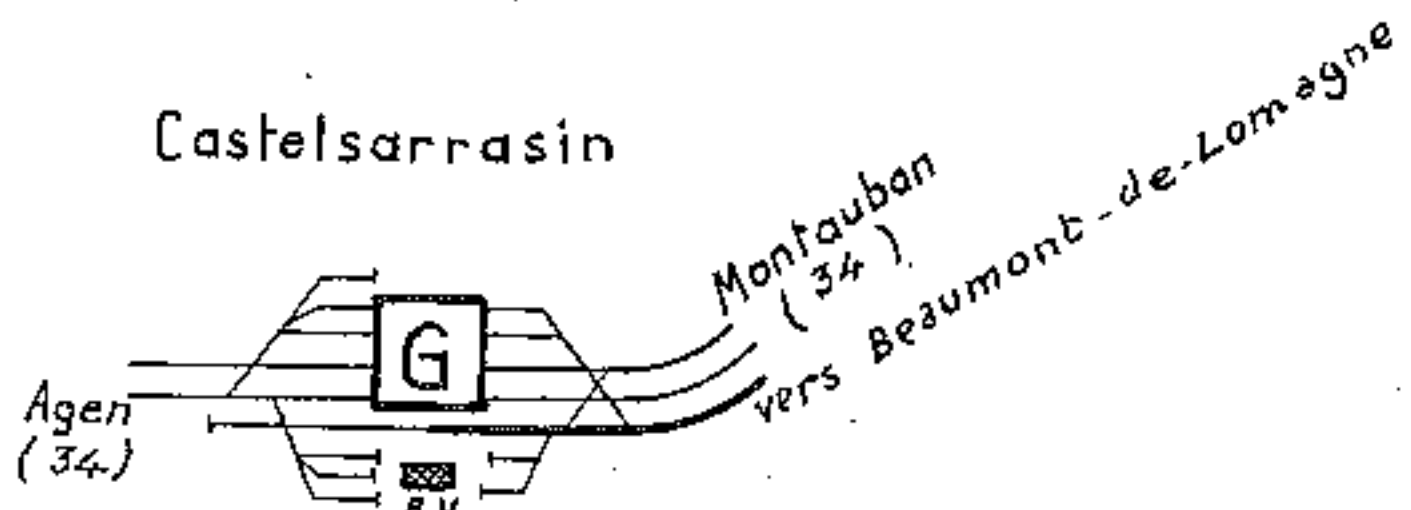
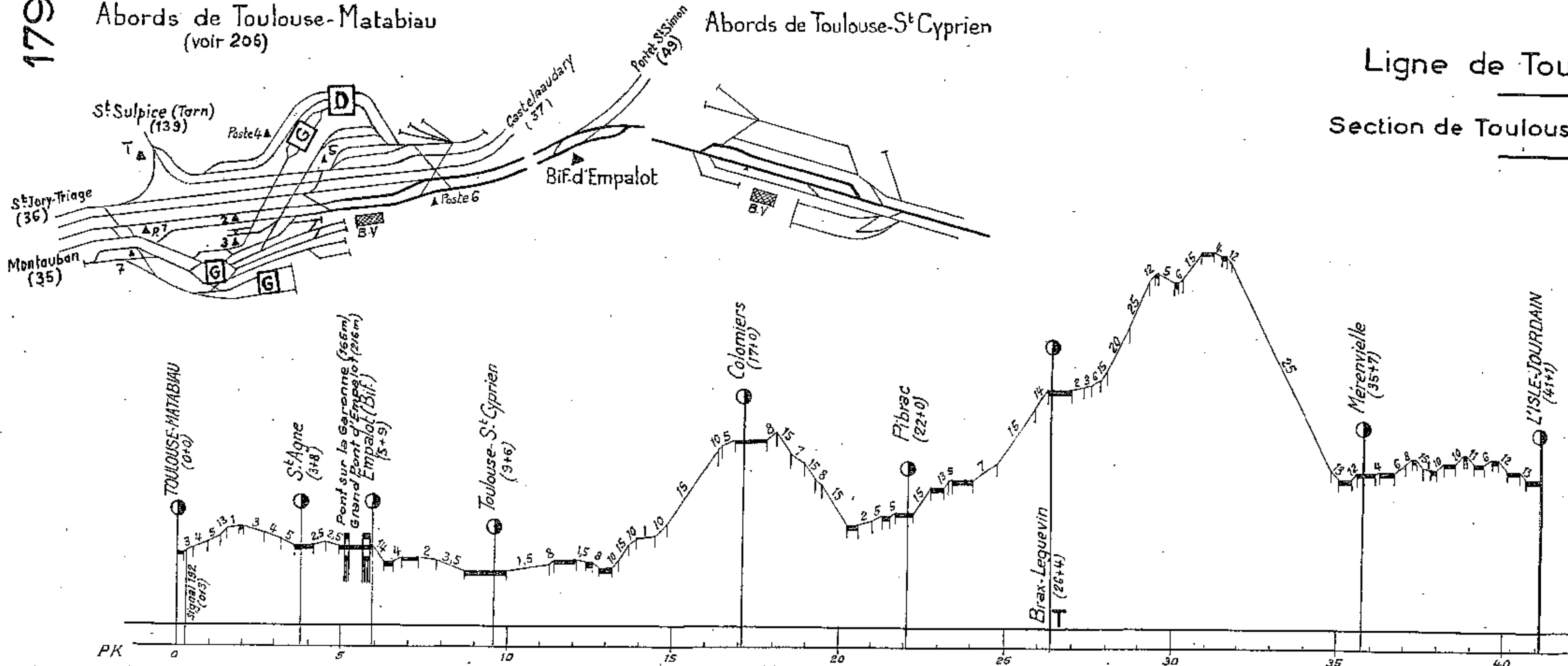

Ligne de Castelsarrasin à
Beaumont de Lomagne

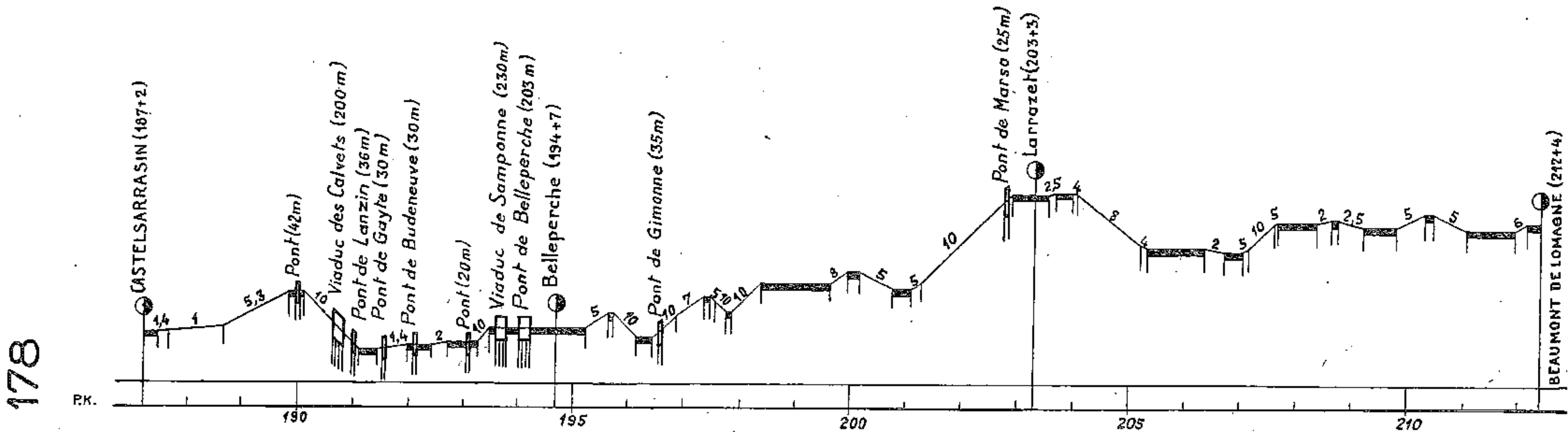

Bifurcation de la Nive

Ligne du Poste de la Nive à Bayonne - Allées Marines

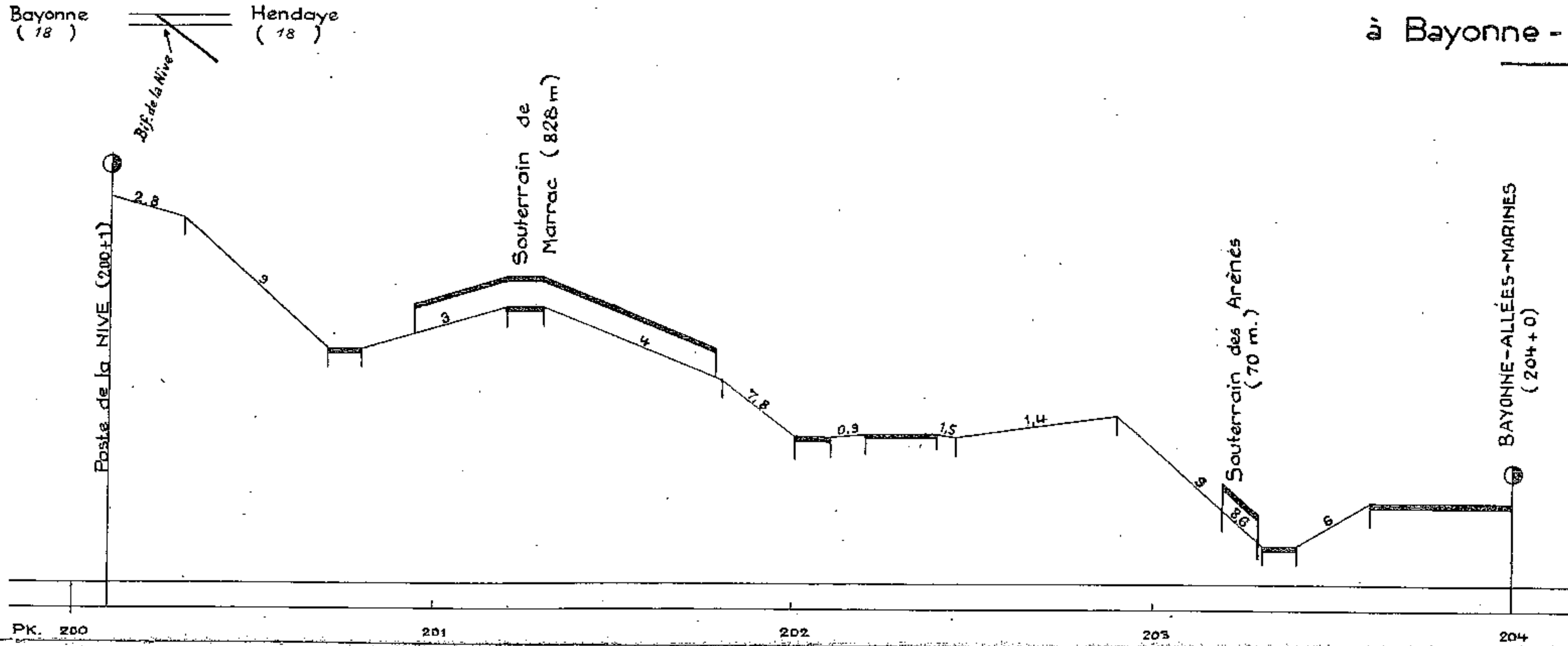

Ligne de Toulouse à Auch

Section de l'Isle-Jourdain à Auch

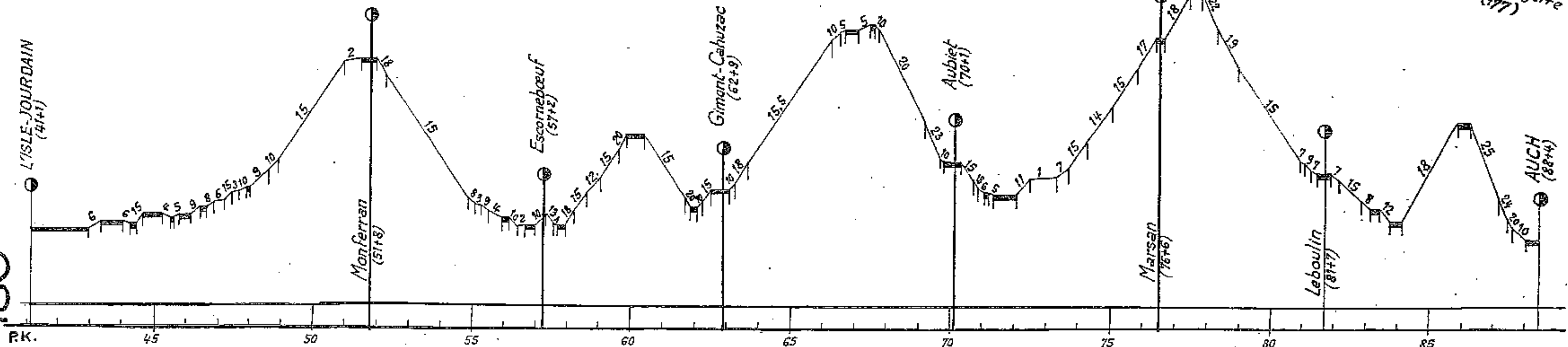

Abords de Bayonne

Abords d'Ossès-S^t-Martin-d'Arrossa

Ligne de Bayonne à S^t Jean Pied-de-Port et d'Ossès-S^t Martin d'Arrossa à S^t Etienne de Baigorri

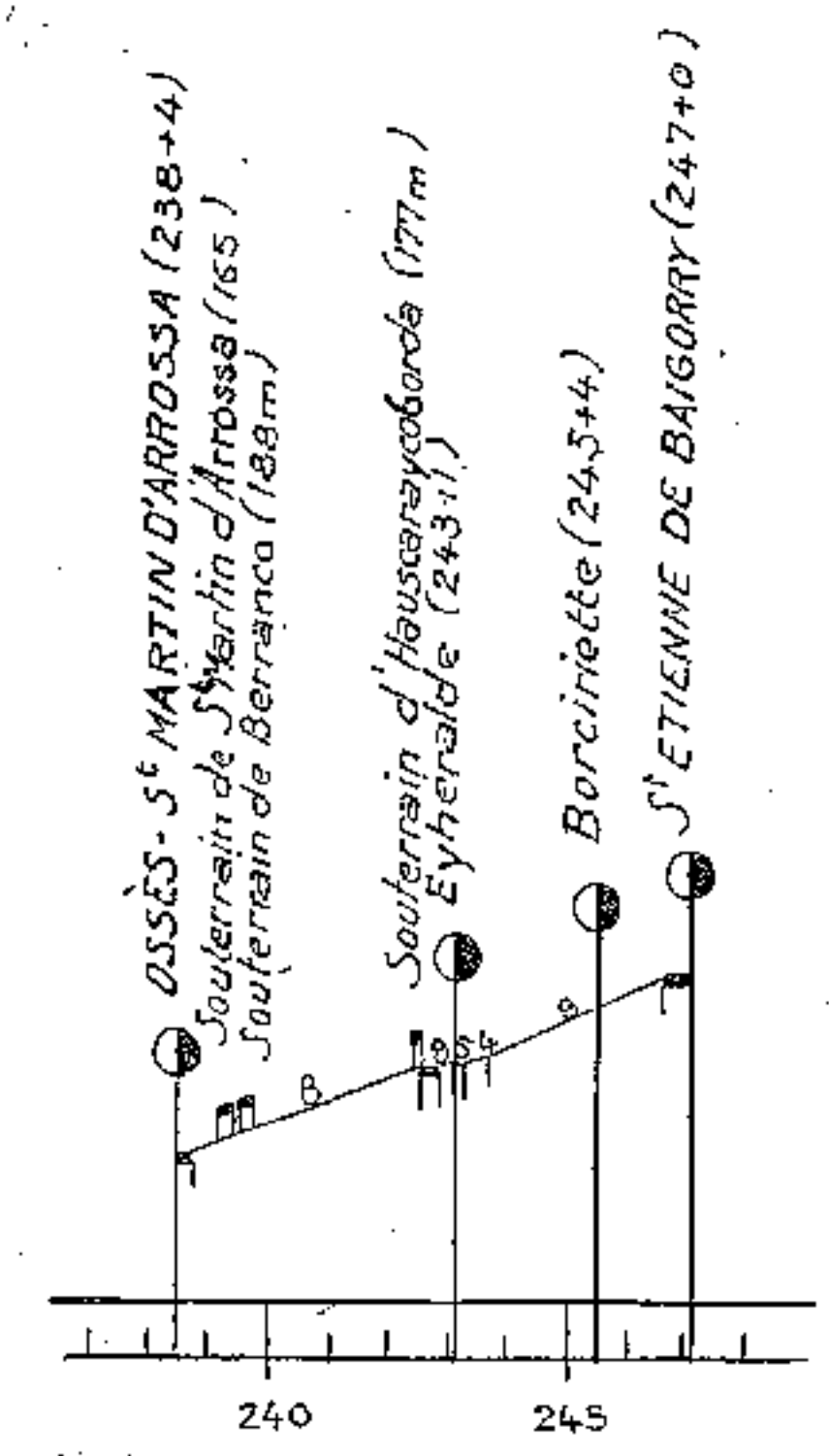
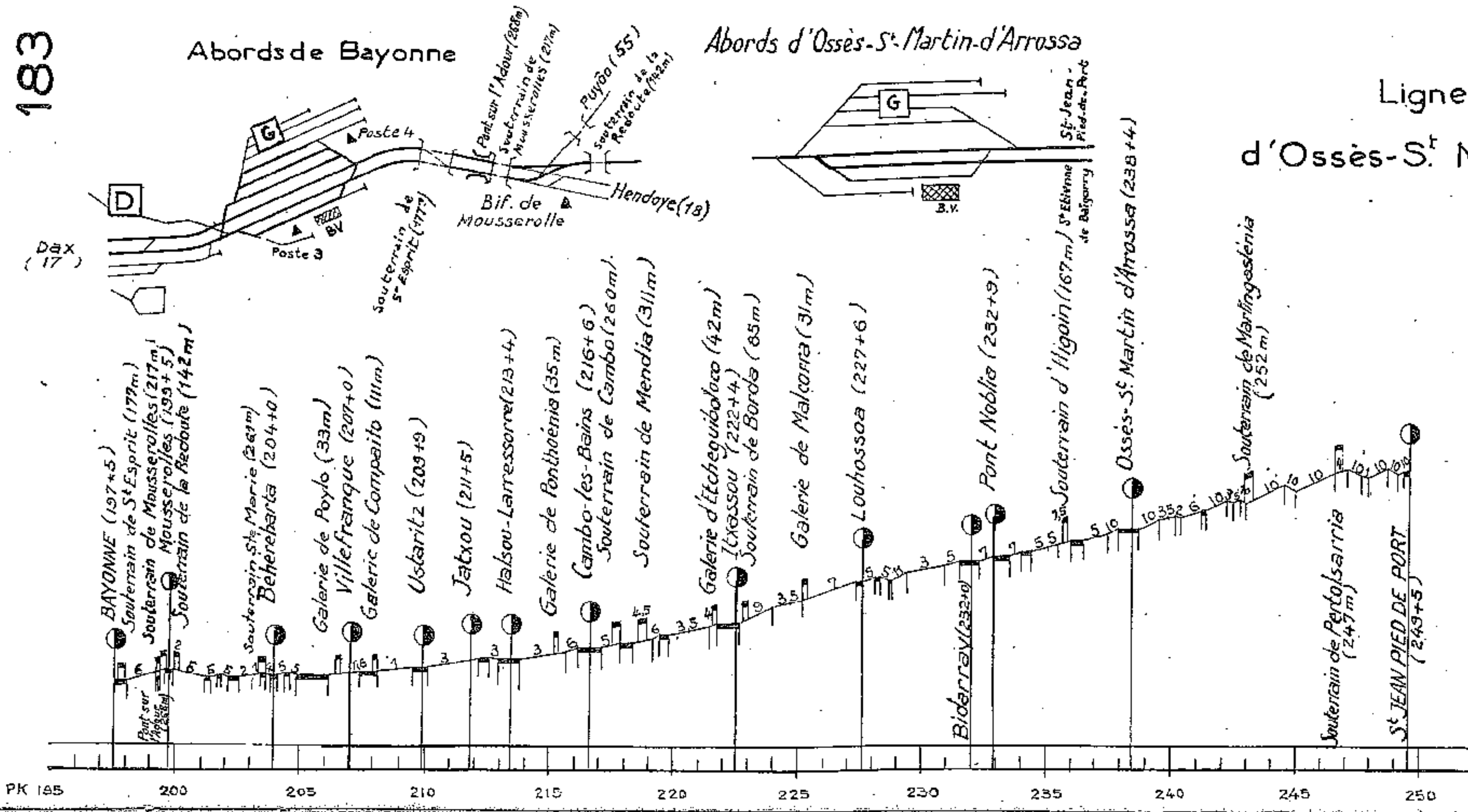

Abords de Biarritz-la-Négresse

Ligne de Biarritz-la-Négresse à Biarritz-Ville

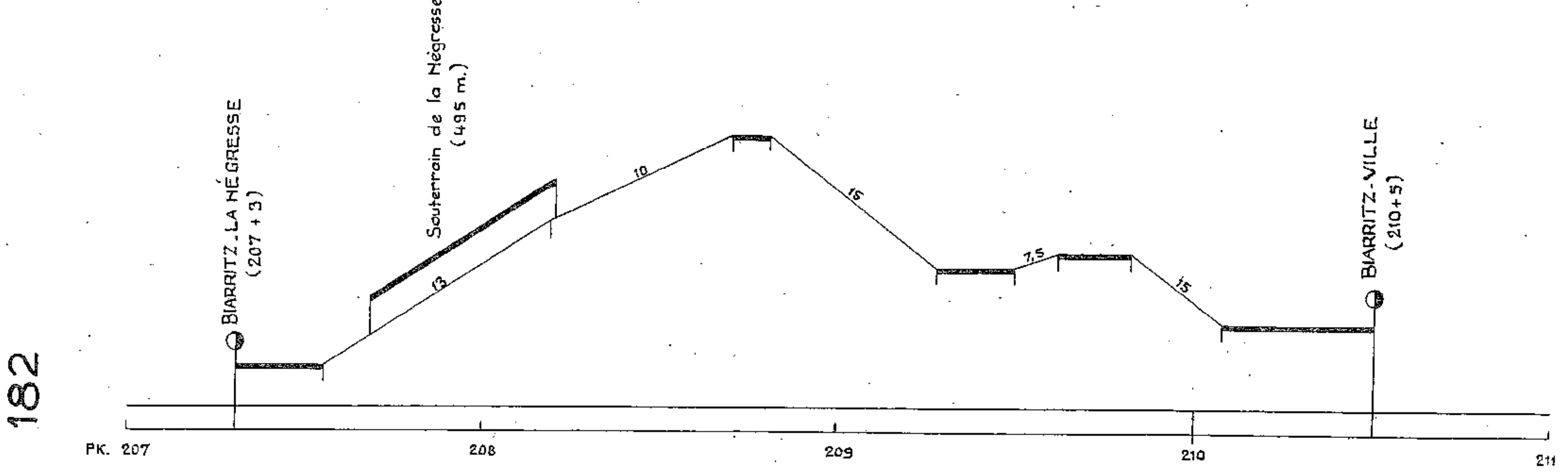
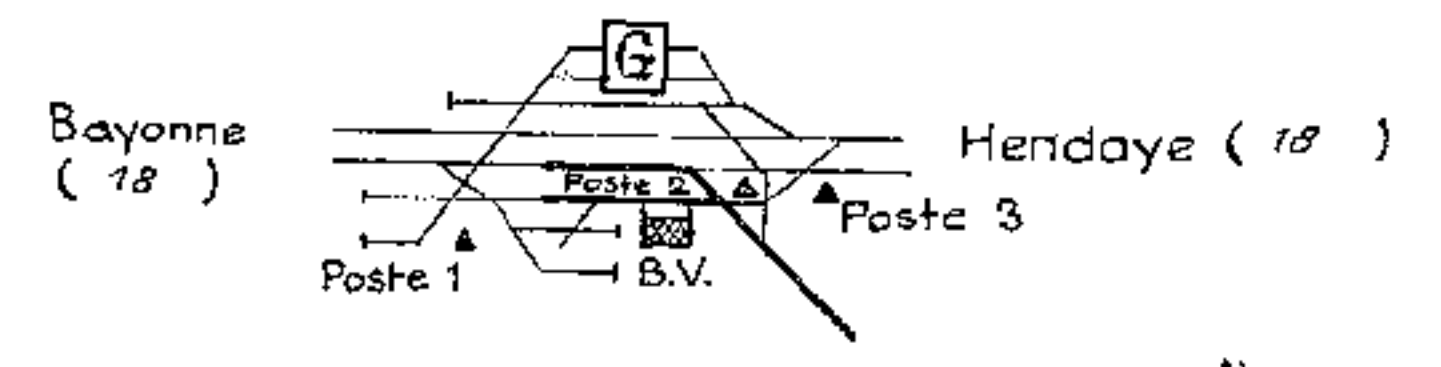

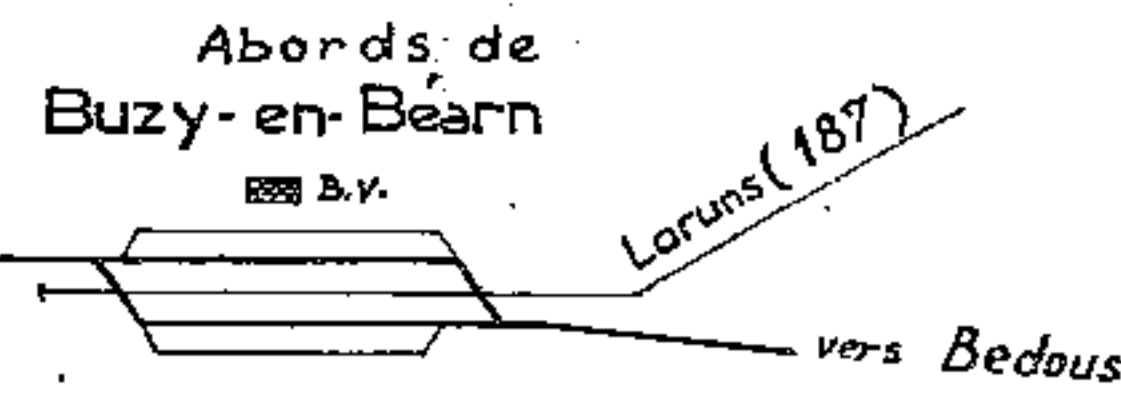
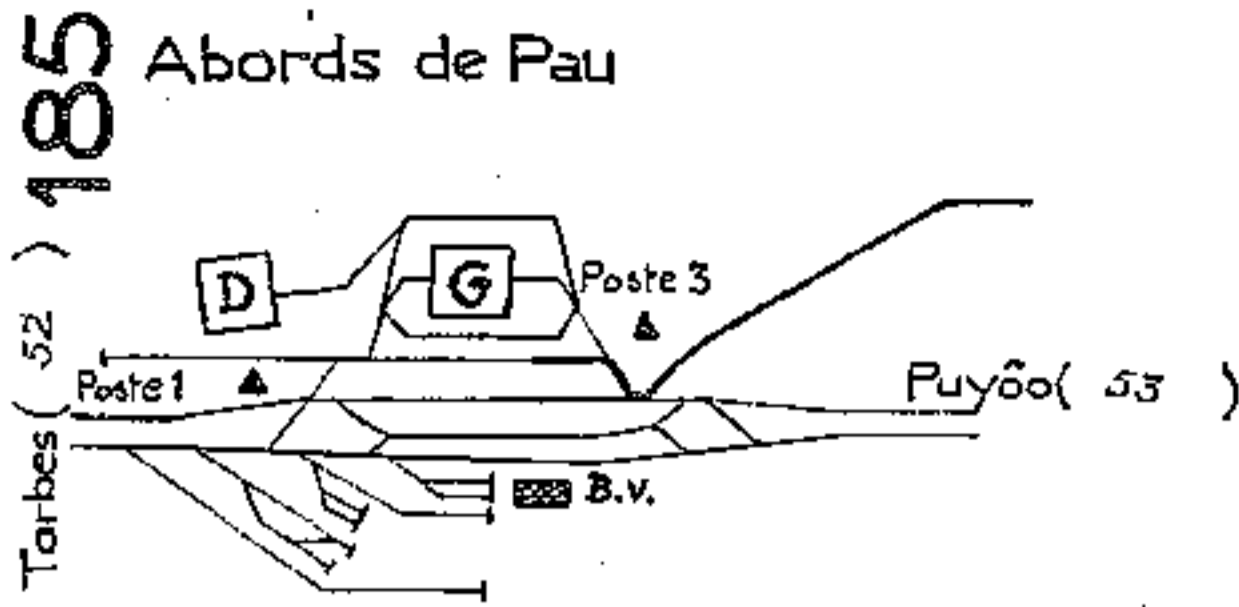

Ligne de Pau à Canfranc
Section Pau-Bedous

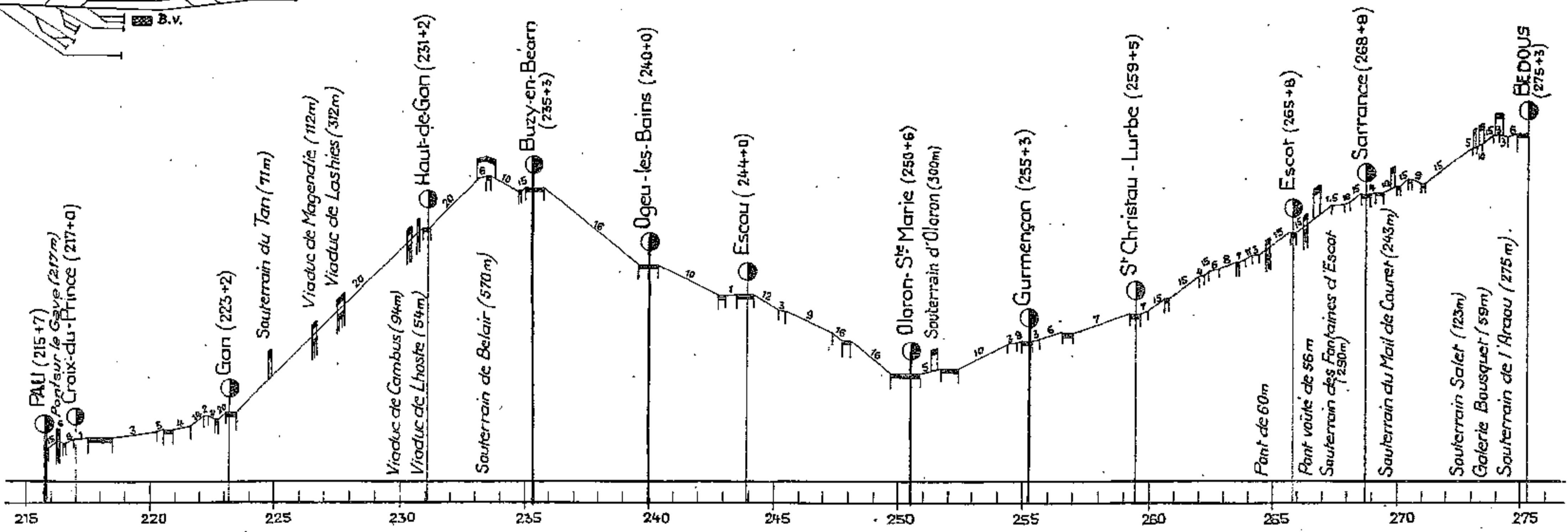

Abords de Puyôo

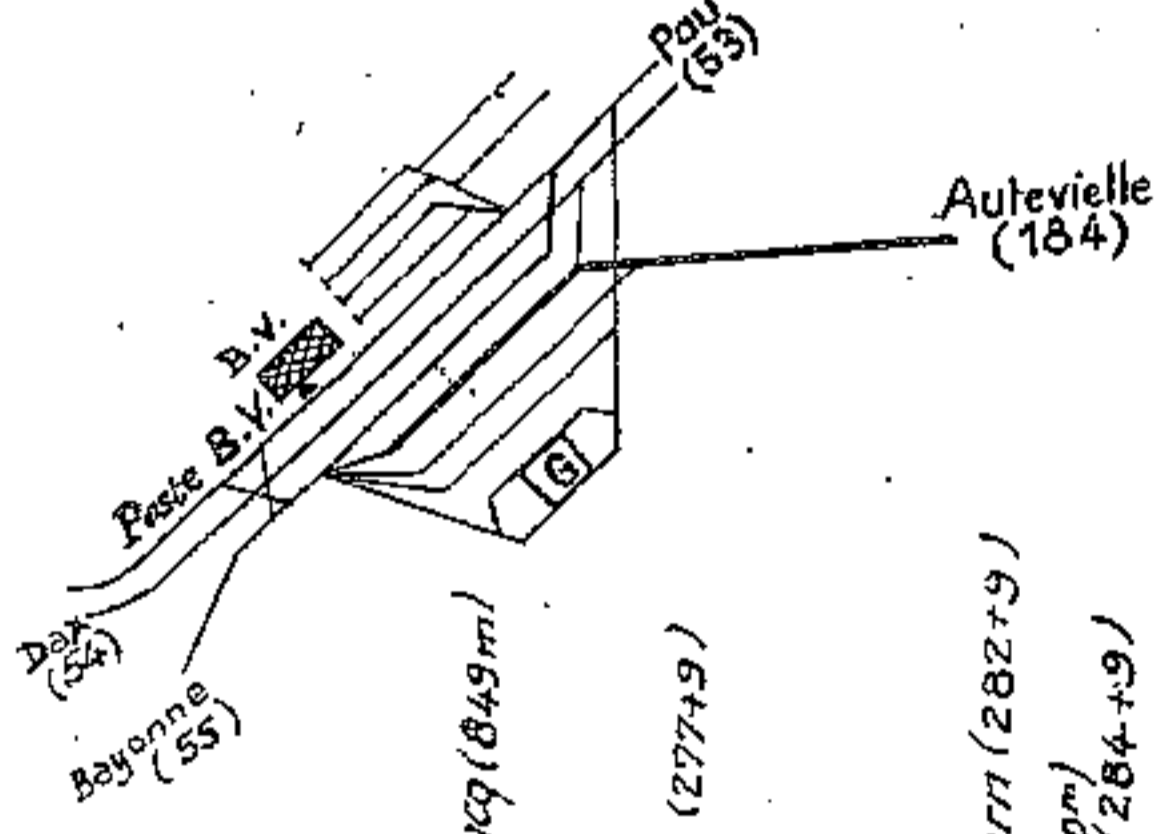

Abords d'Autevielle

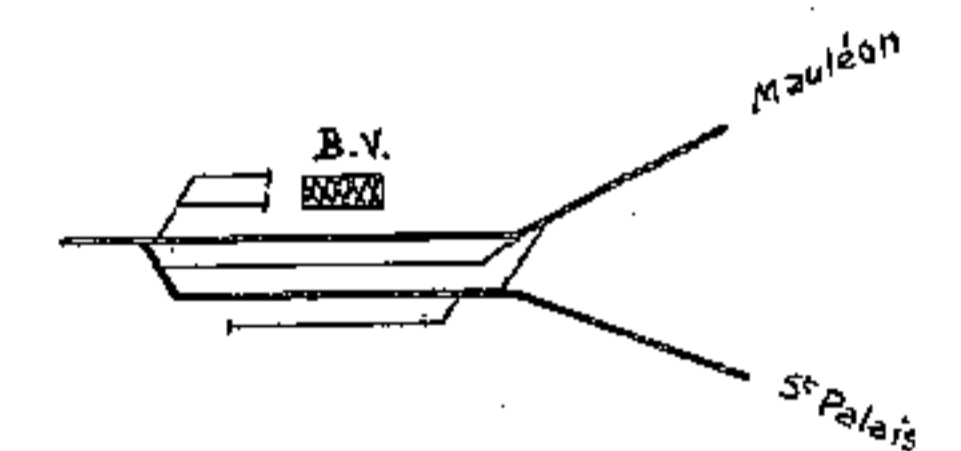

Lignes de Puyôo à Mauléon et
d'Autevielle à St. Palais

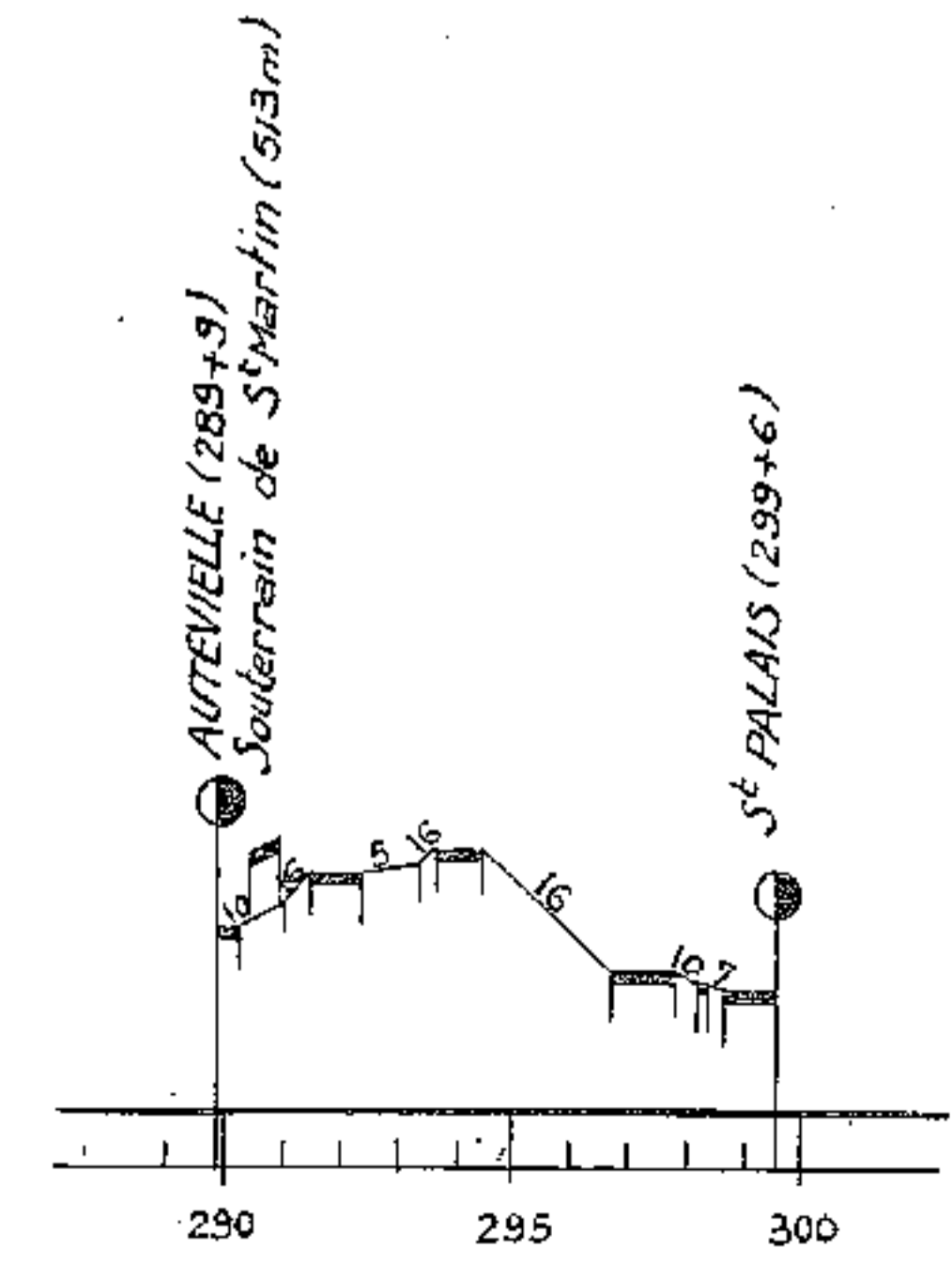
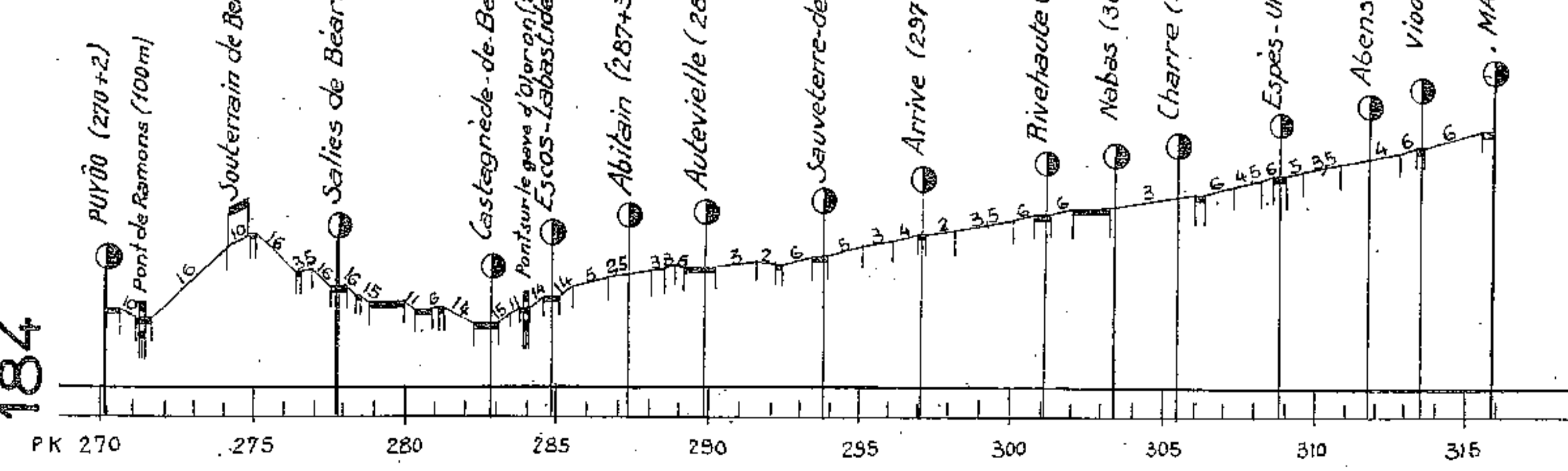

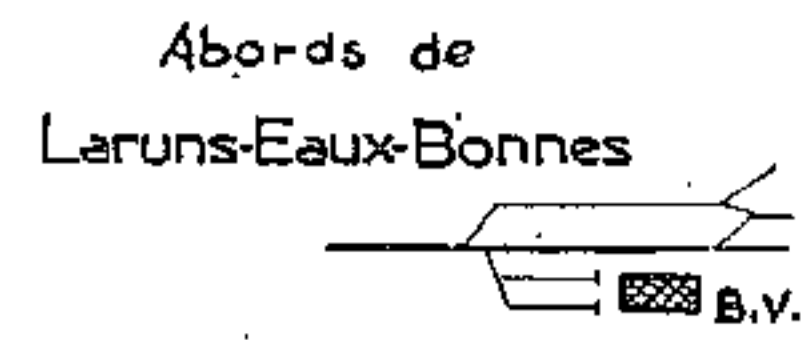
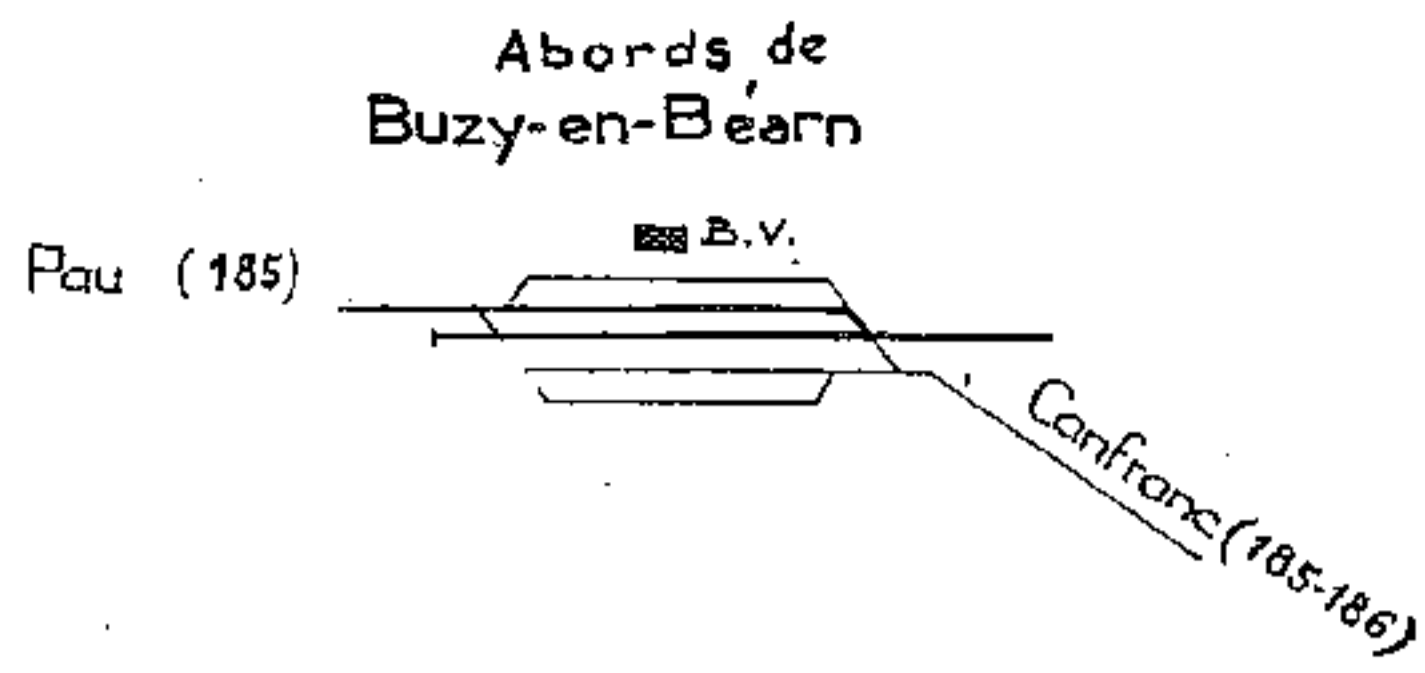

Ligne de Buzy-en-Bearn à Laruns-Eaux-Bonnes

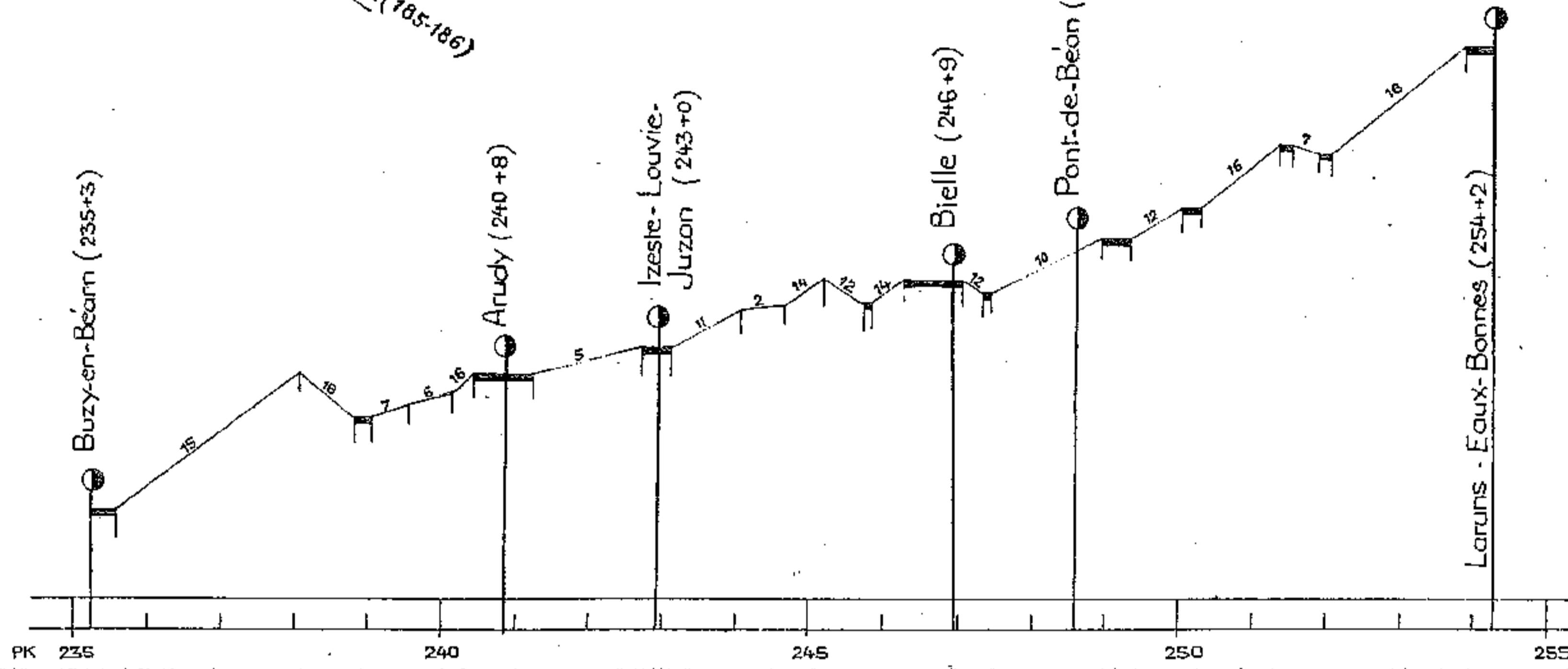

Ligne de Pau à Canfranc

Section Bedous-Canfranc

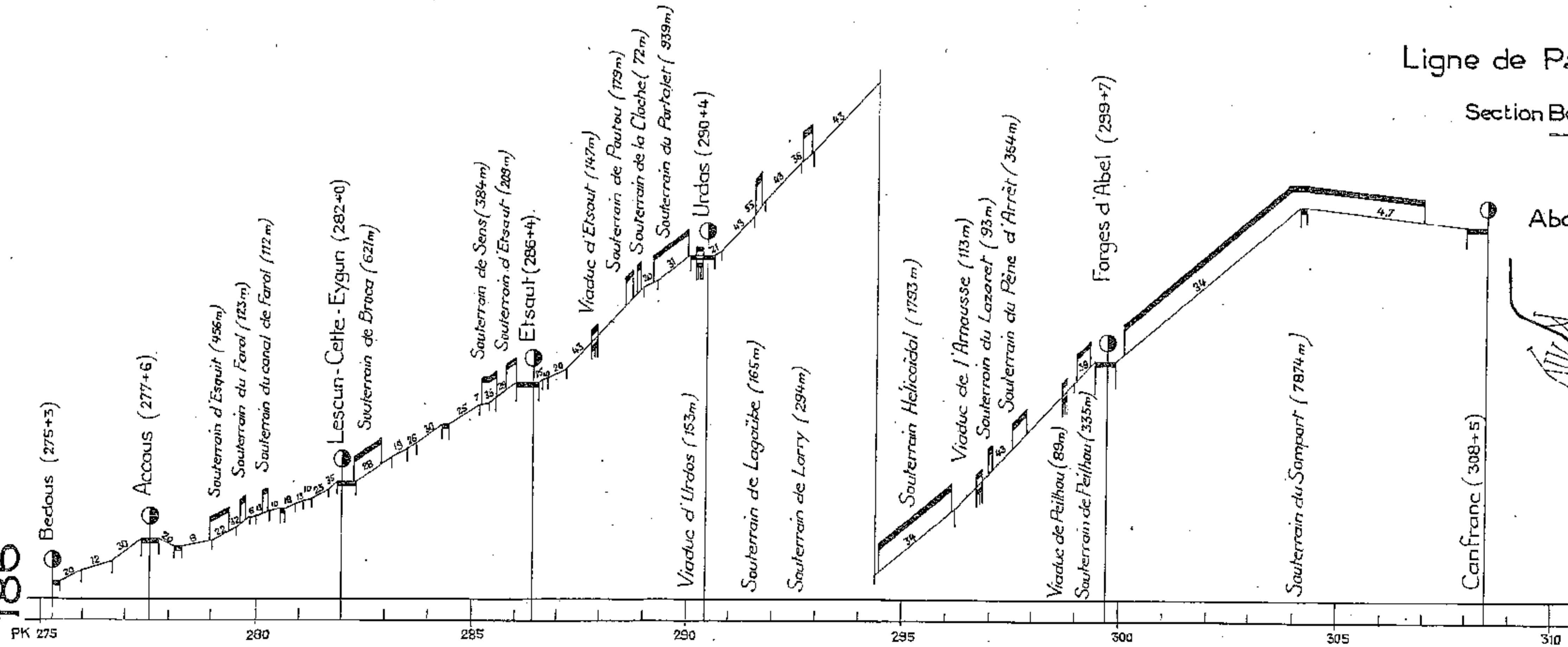

Abords de Canfranc

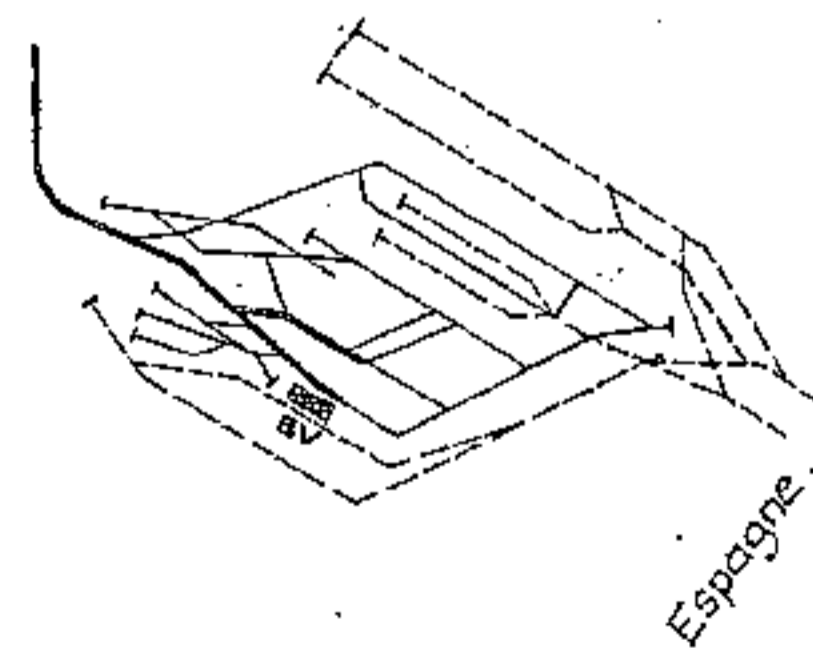



Abords d'Ampèrevielle

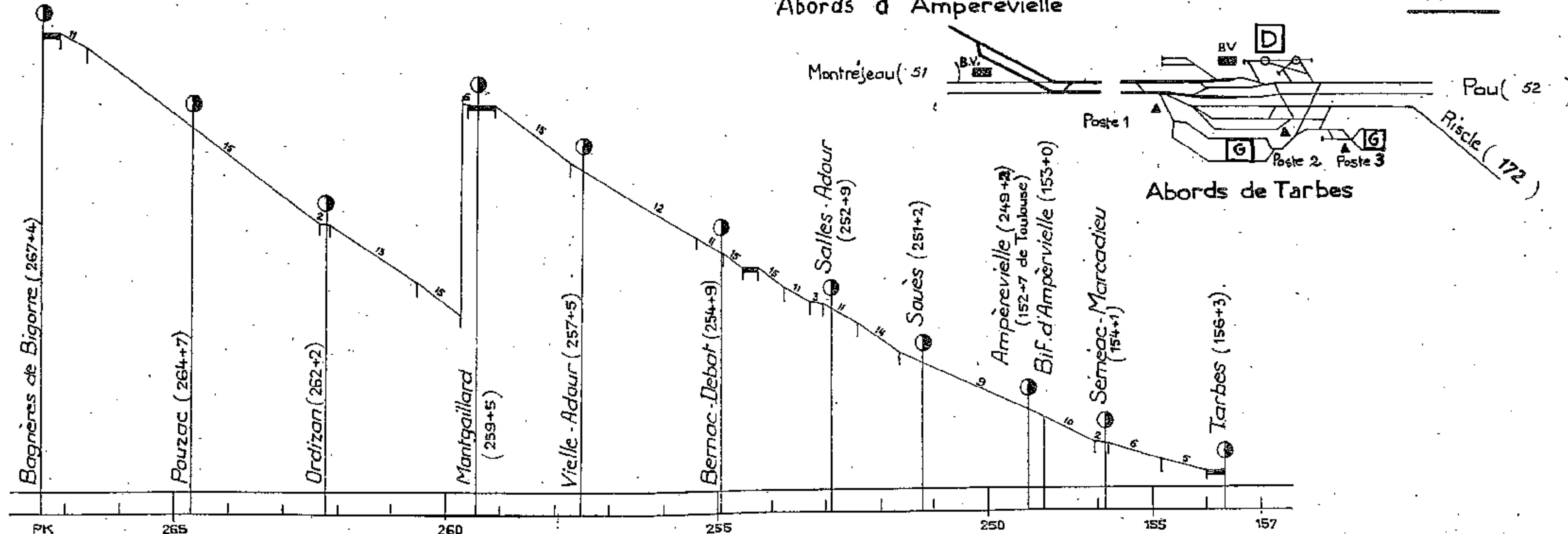

Abords de Lourdes

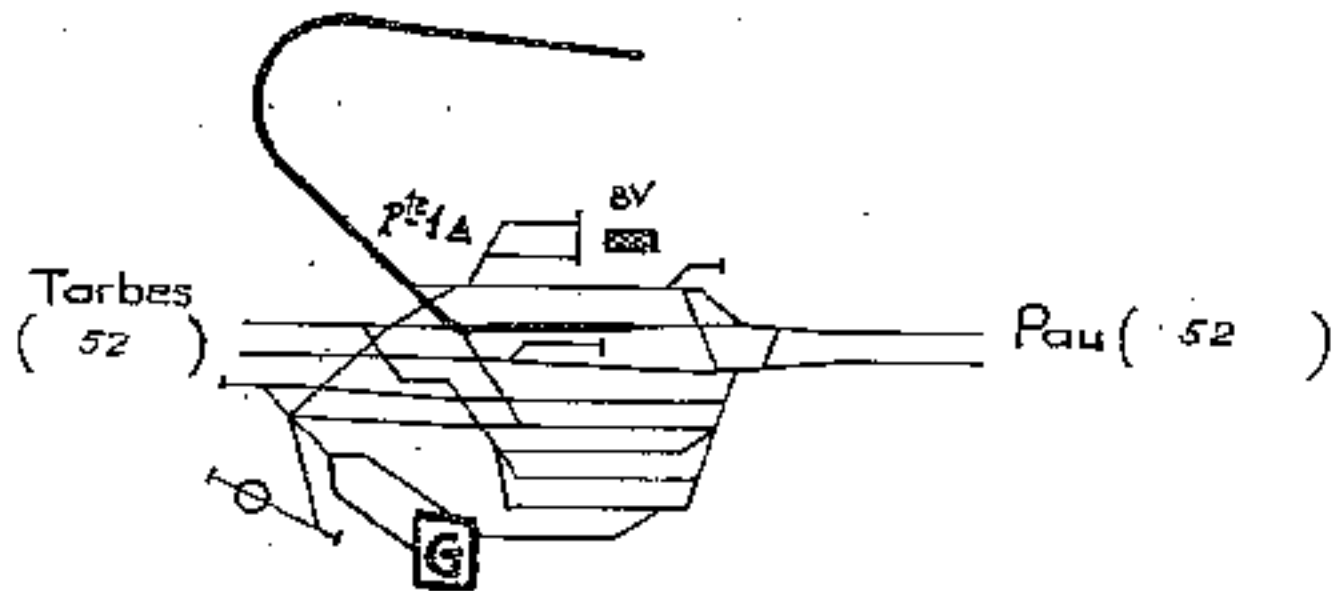

Pierrefitte-Nestalas

Ligne de Lourdes

à

Pierrefitte-Nestalas

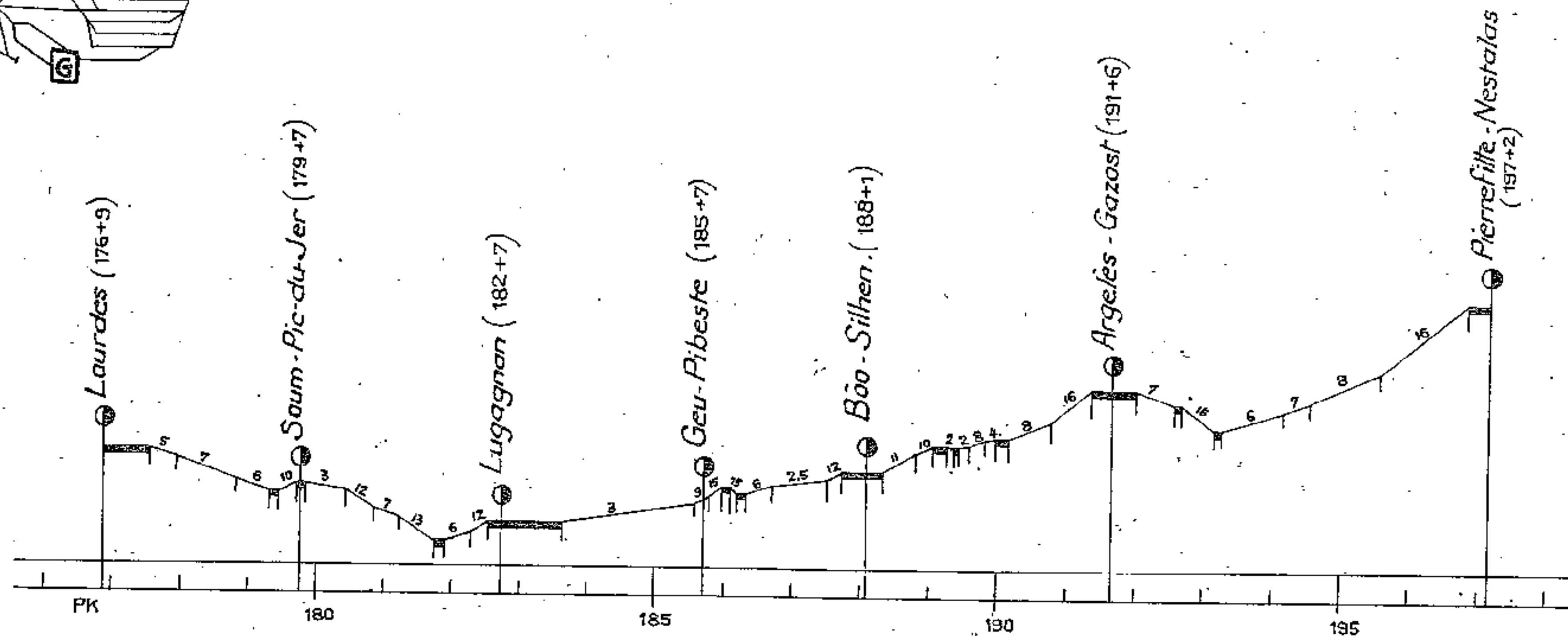

Abords de Montréjeau-Gourdan-Polignan

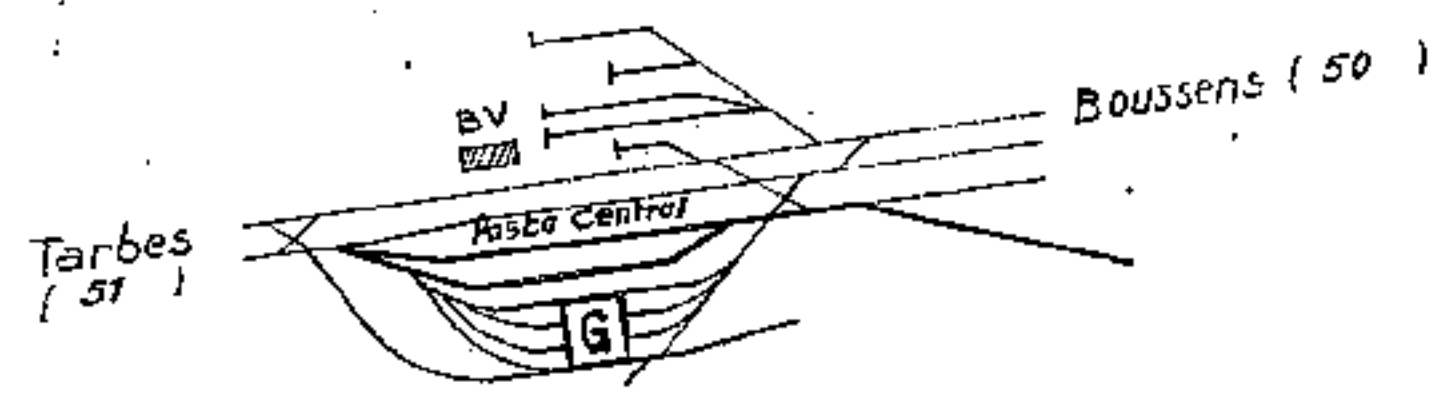

Ligne de Montréjeau-Gourdan-Polignan à Luchon

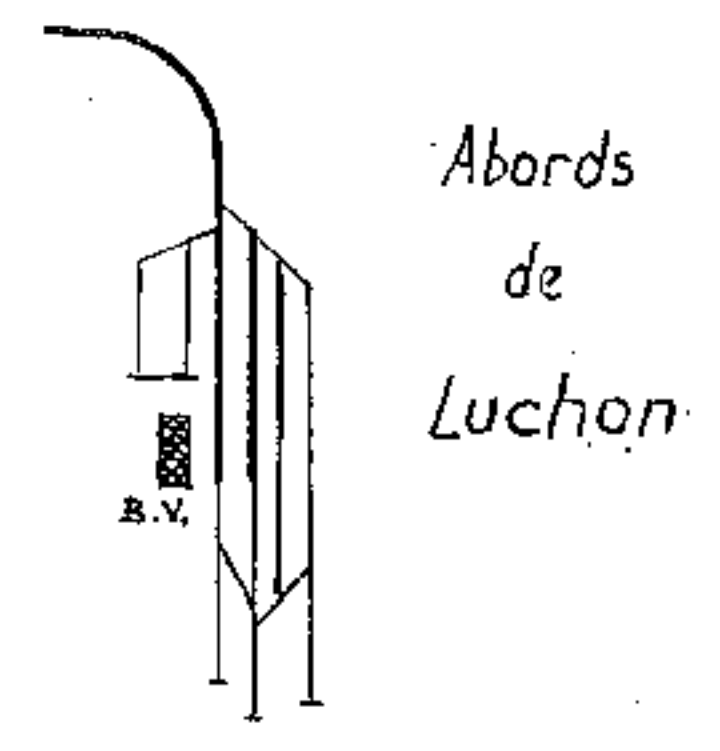
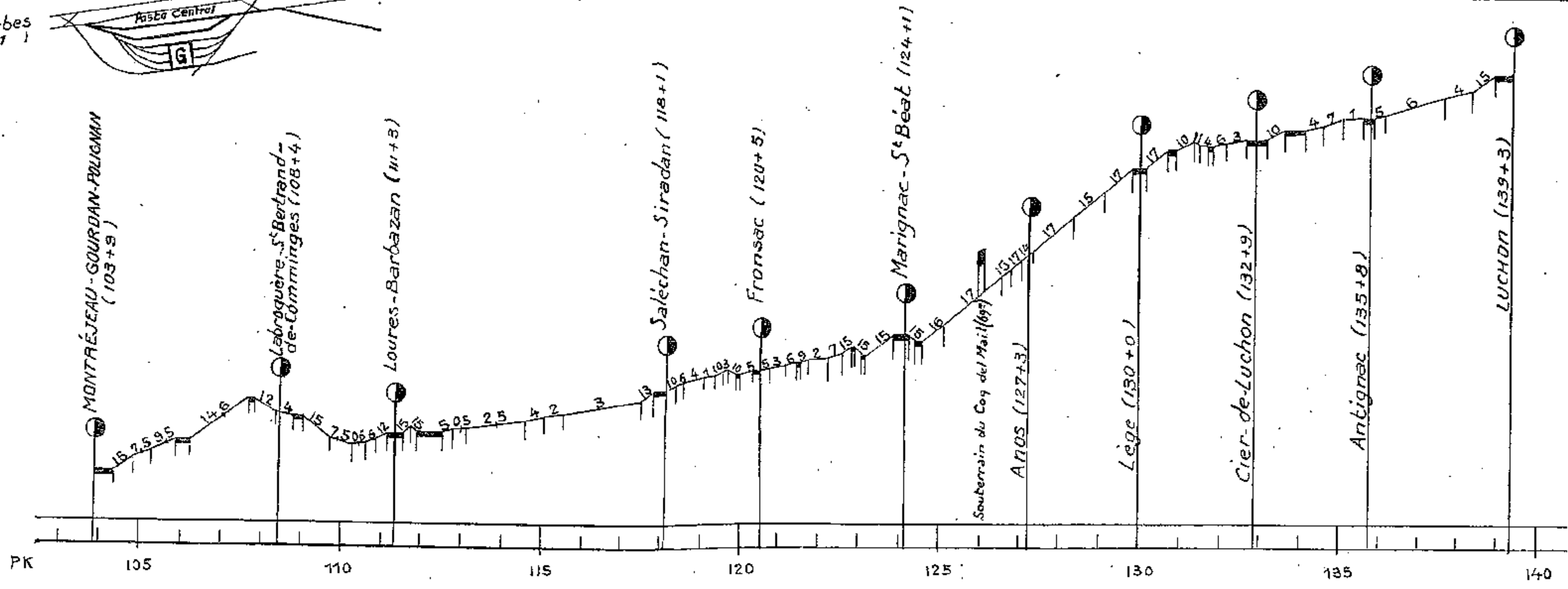

Abords de Luchon

Abords de Lannemezan

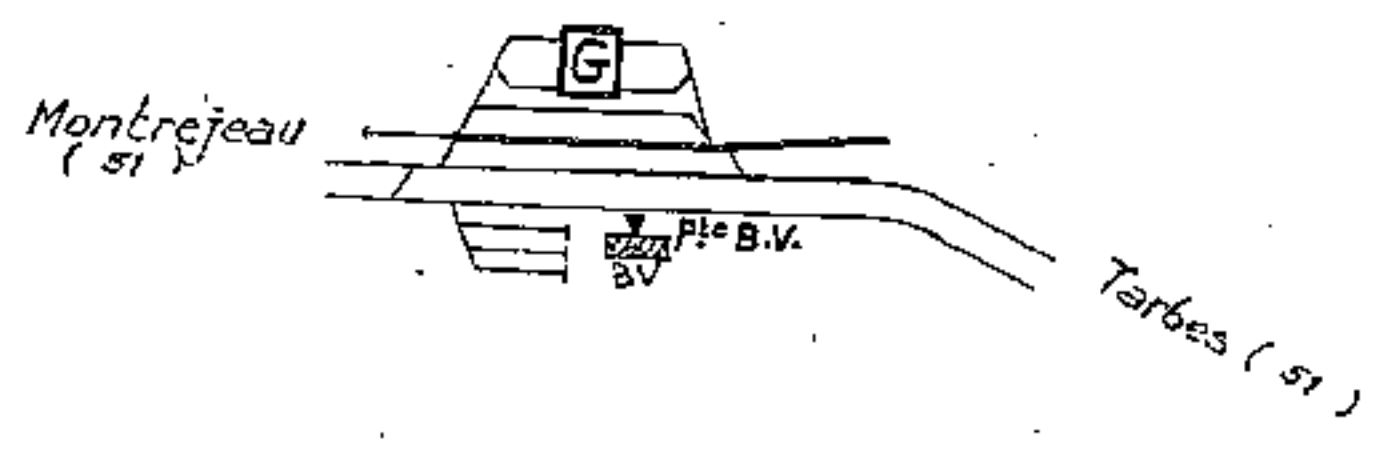

Ligne de Lannemezan à Arreau-Cadéac

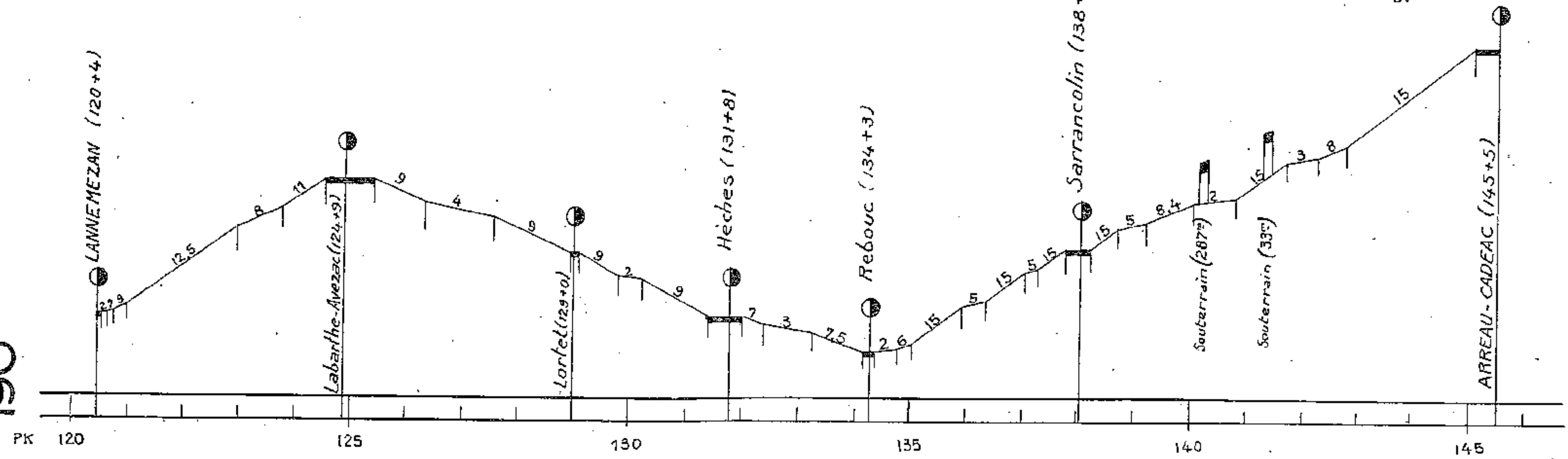

Abords d'Arreau-Cadéac

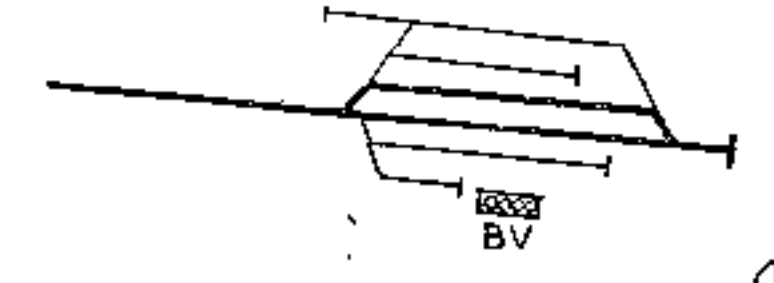

Abords de Foix

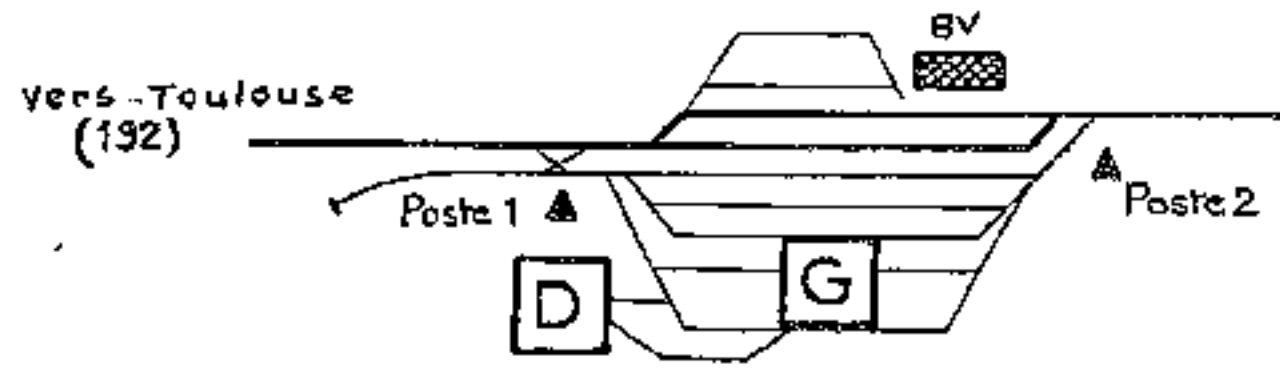

Ligne de Toulouse-Matabiau à la Tour-de-Carol et Puigcerda

Section Pamiers - Ax-les-Thermes

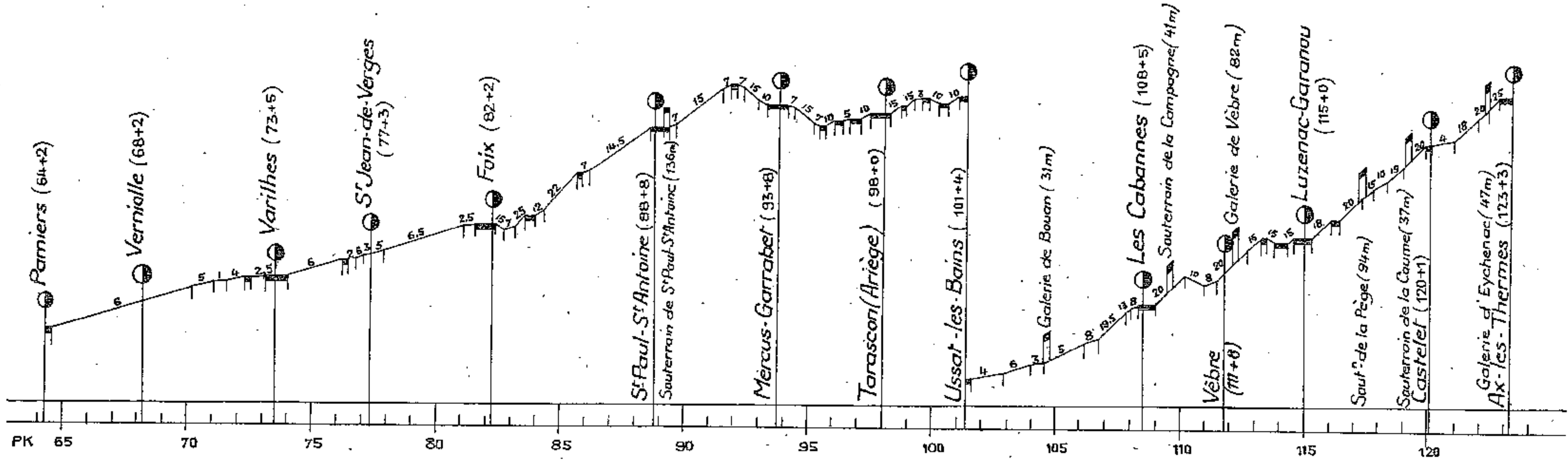

Abords de Toulouse-Matabiau

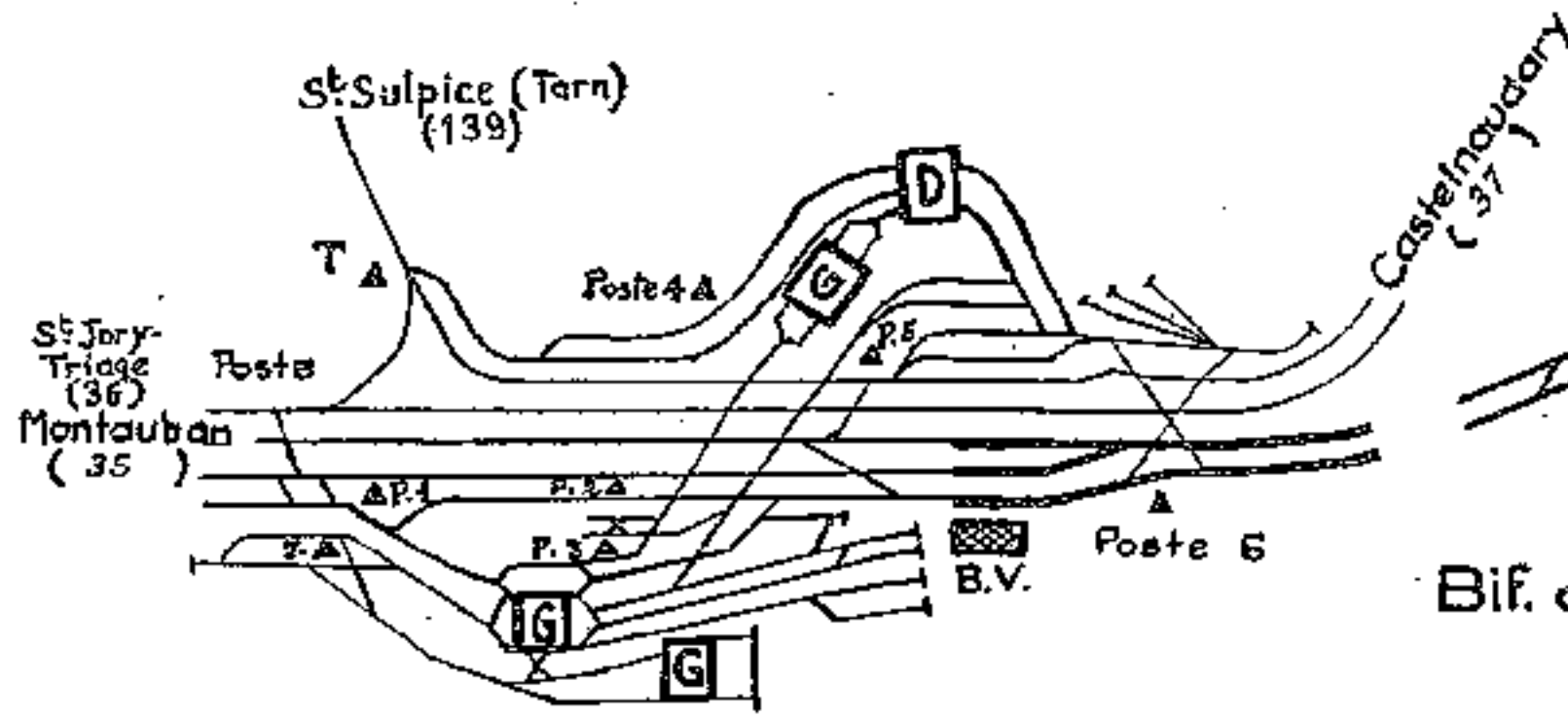

Abords de Portet-S^t Simon

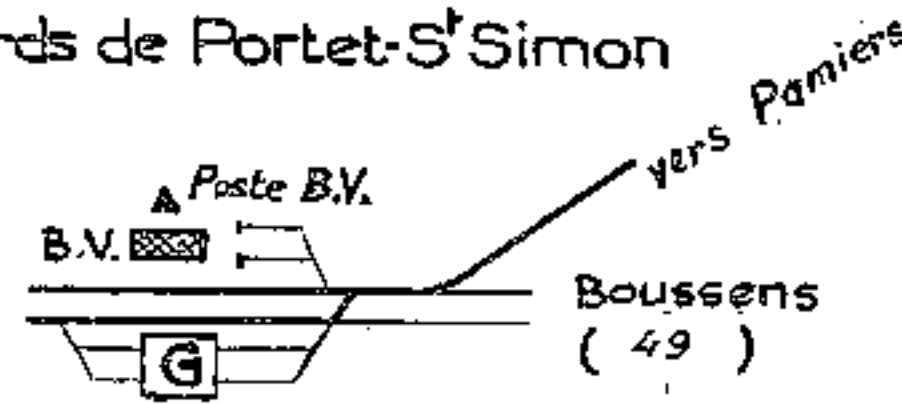

Ligne de Toulouse-Matabiau à la Tour-de-Carol et Puigcerda

Section Toulouse-Pamiers

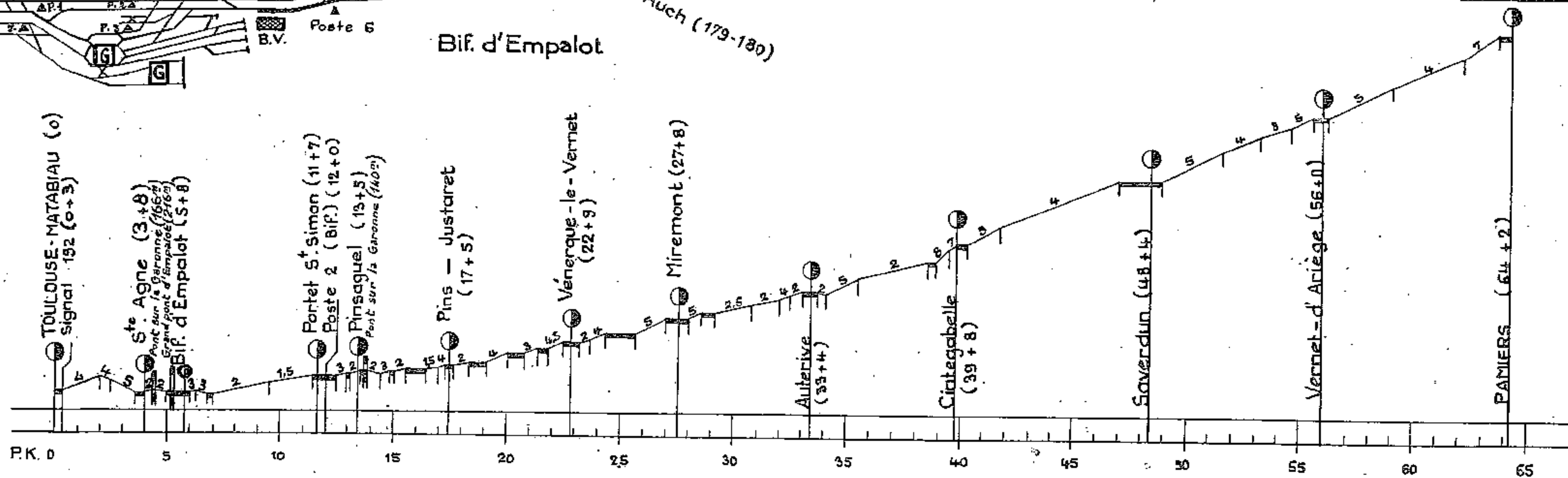

Abords de Boussens

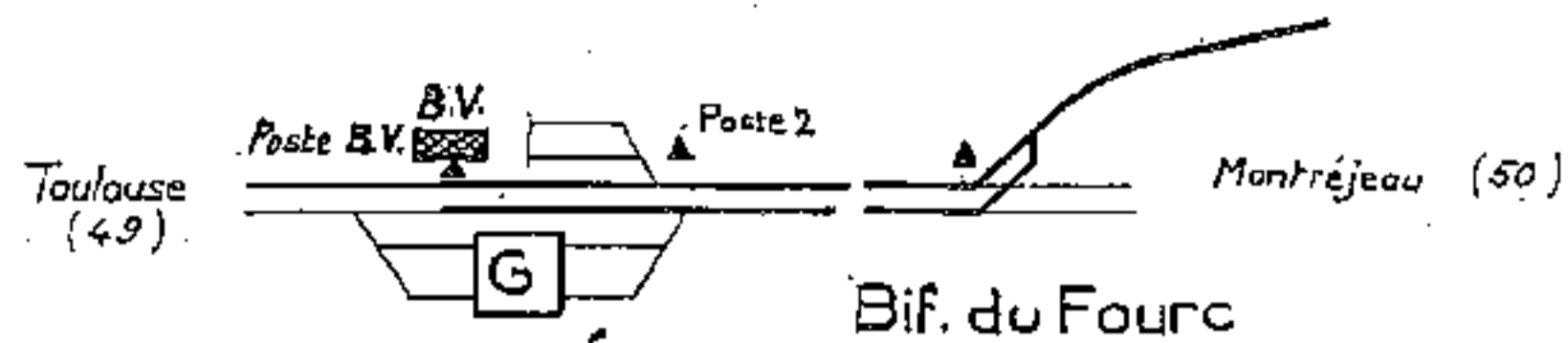

Bif. du Fourc

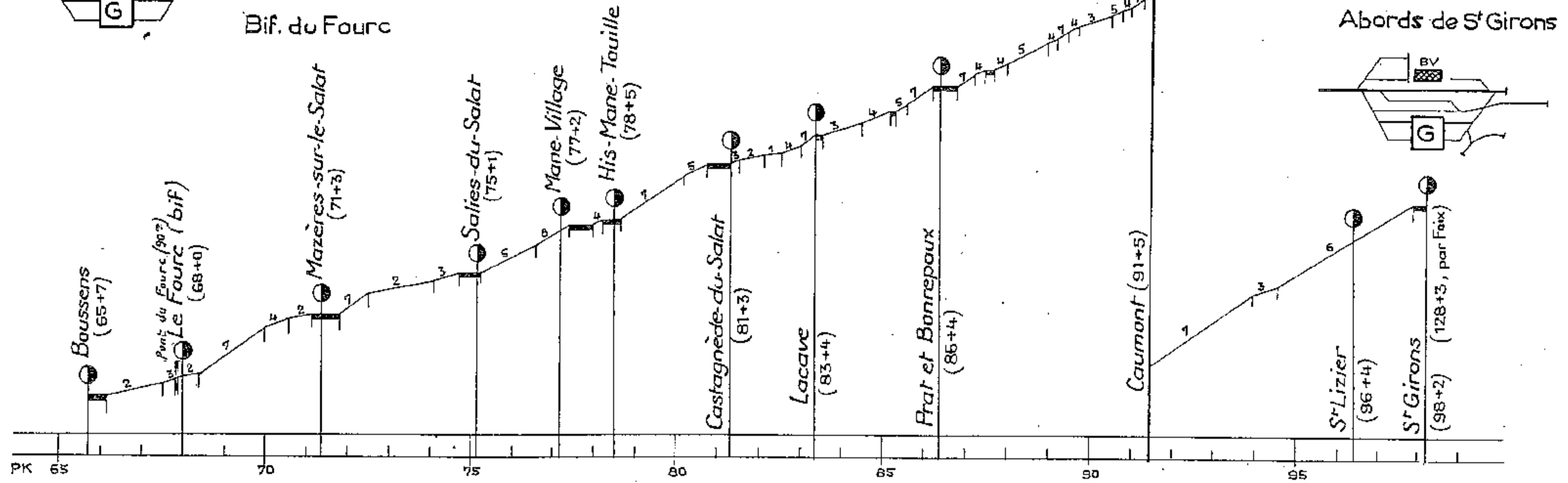

Abords de St-Girons

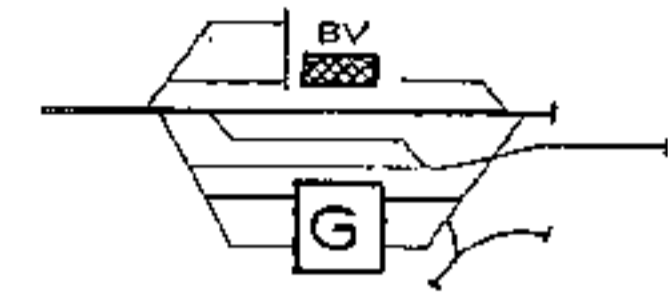

St-Lizier (96+4)
St-Girons (98+2) (128+3, par Faix)

Ligne de Boussens à St-Girons

Ligne de Toulouse-Matabiau à la Tour-de-Carol et Puigcerda.

Section Ax-les-Thermes
La Tour-de-Carol - Puigcerda

Abords de la Tour de Carol

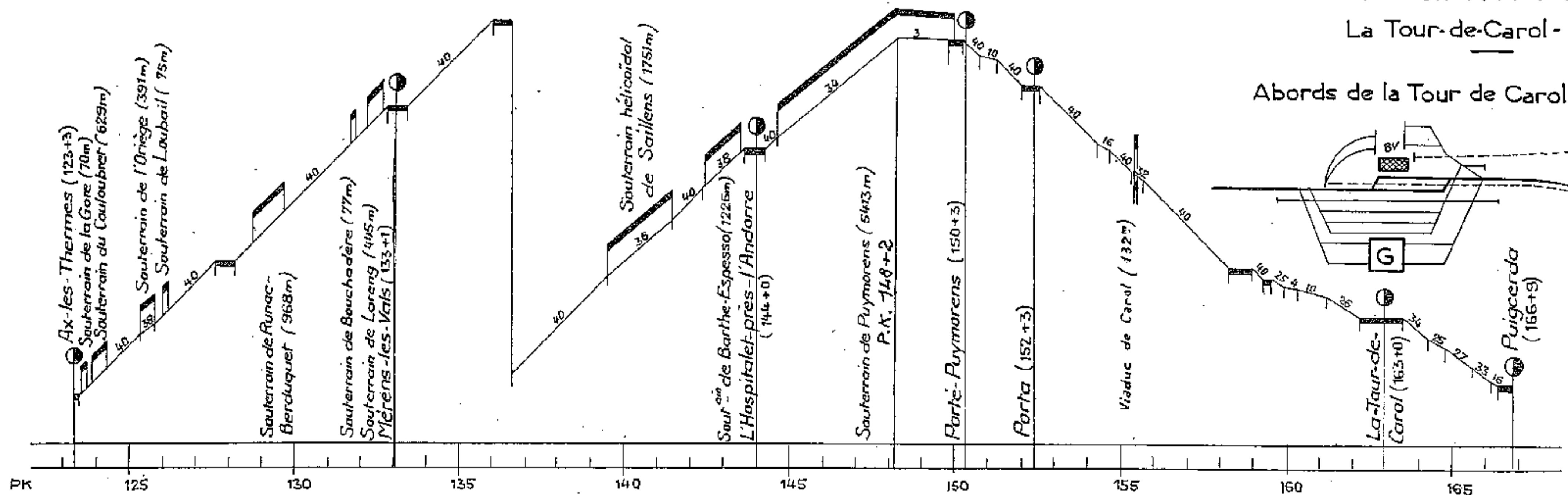
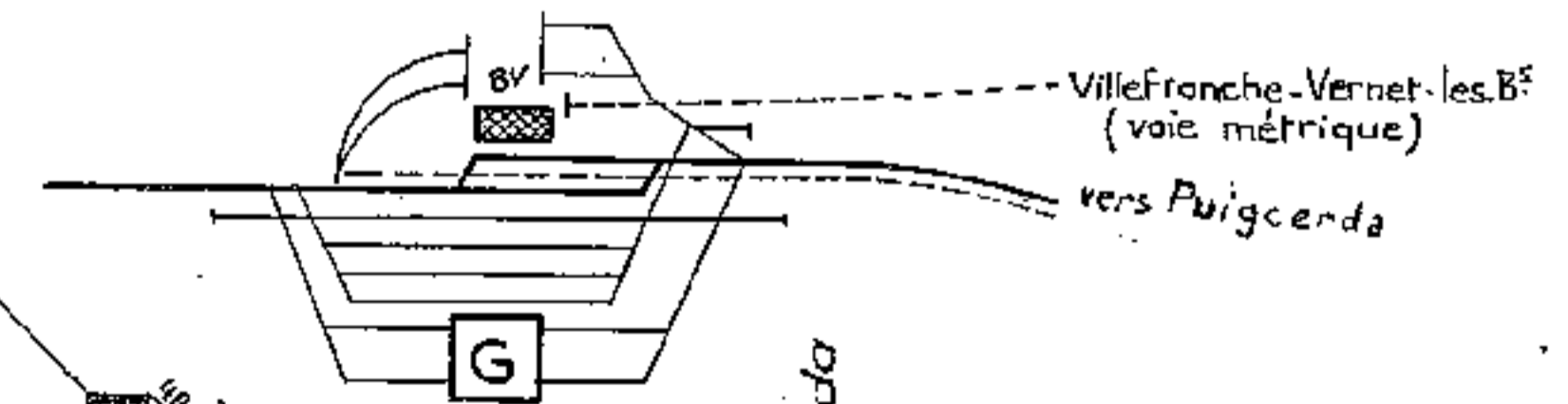

Villefranche-Vernet-les-B²
(voie métrique)
vers Puigcerda

La-Tour-de-Carol (163+0)
Puigcerda (166+3)

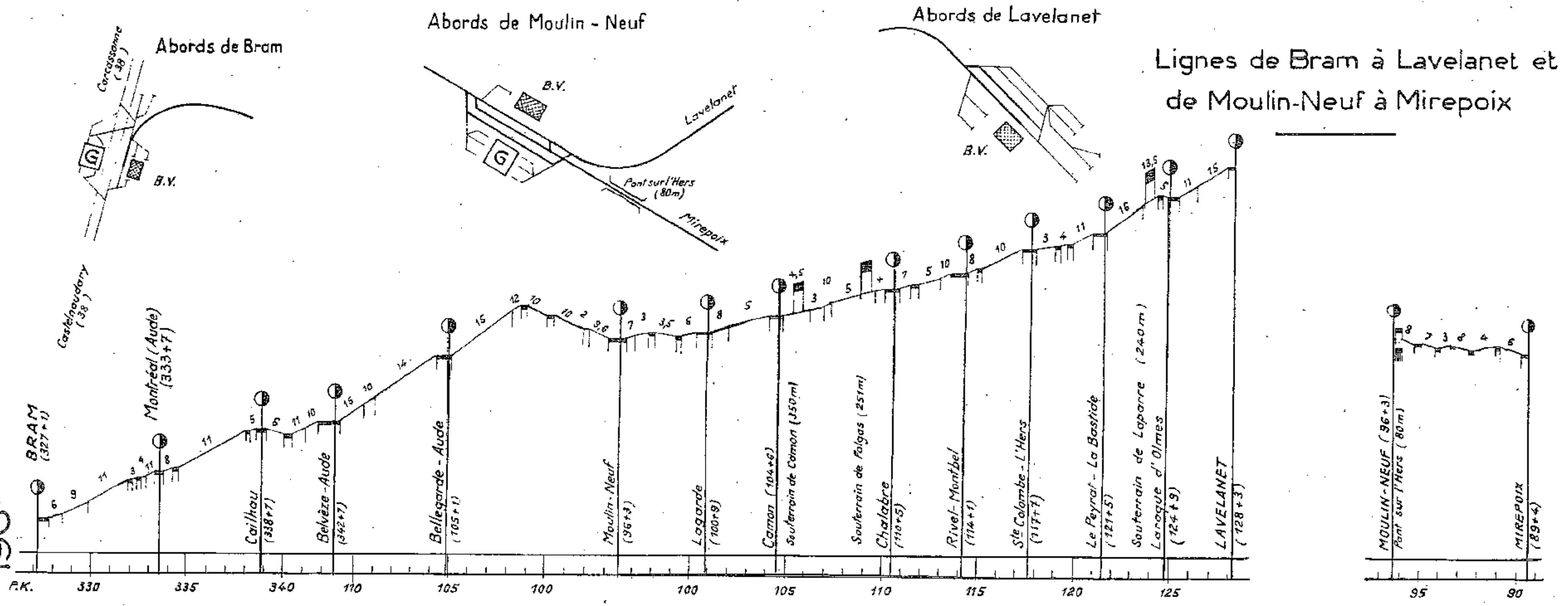
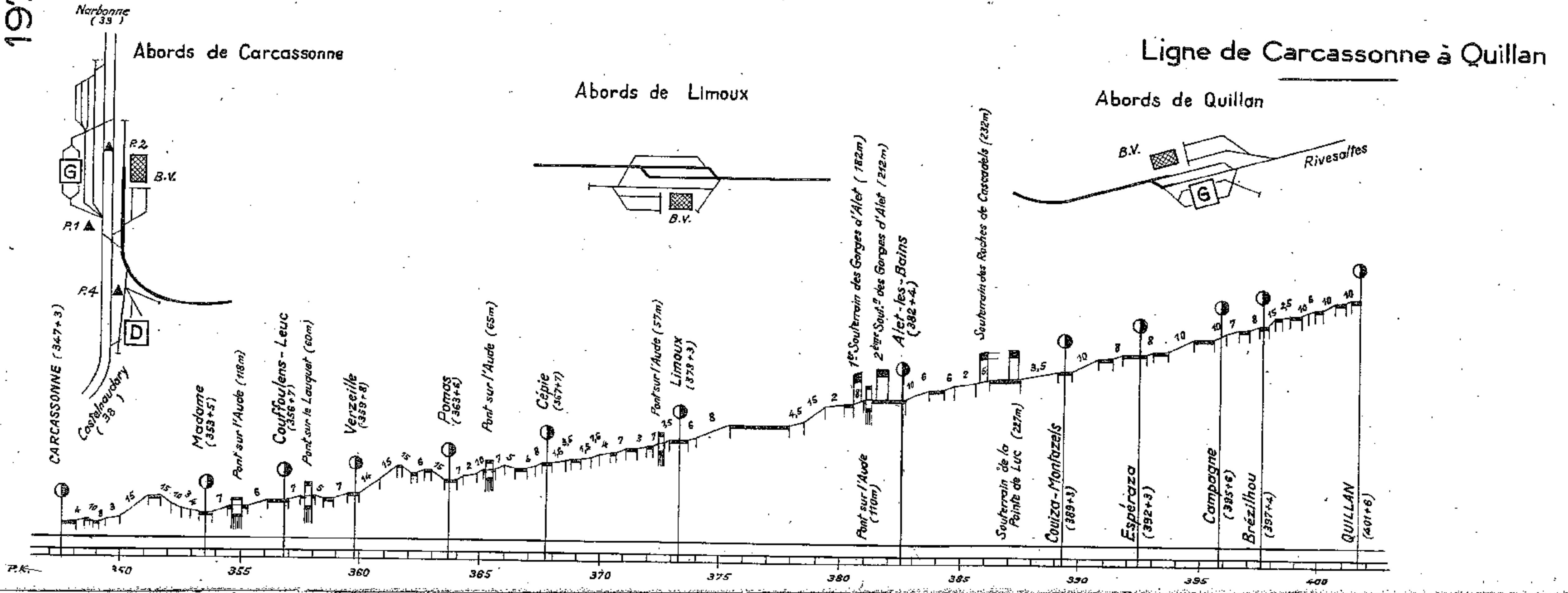

GARE DE JUVISY

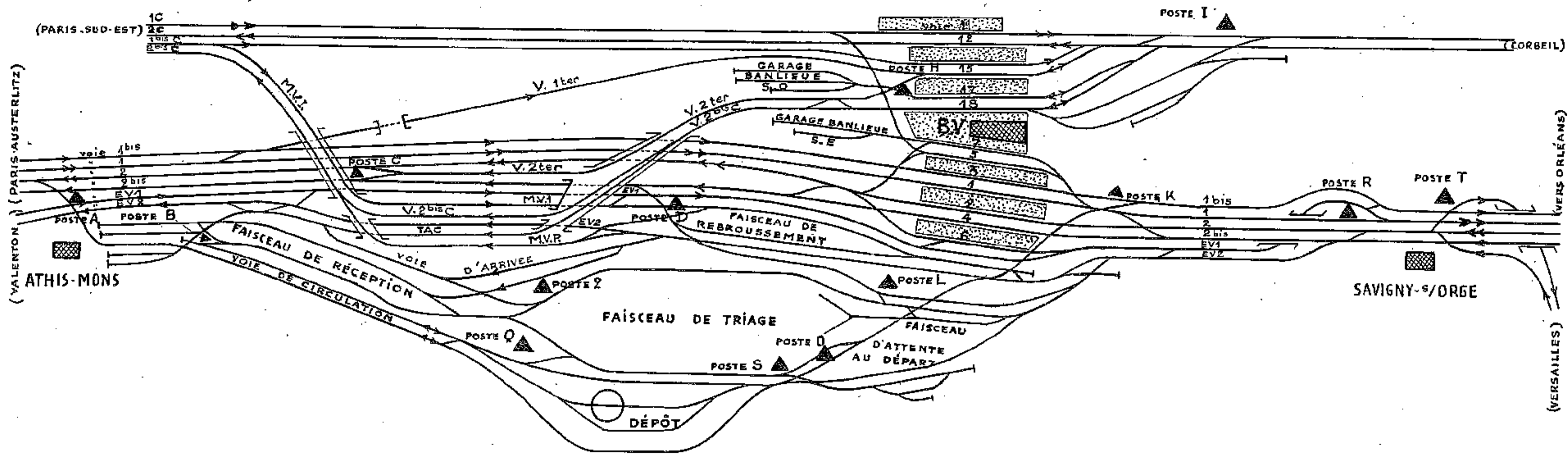

GARE DE PARIS-AUSTERLITZ

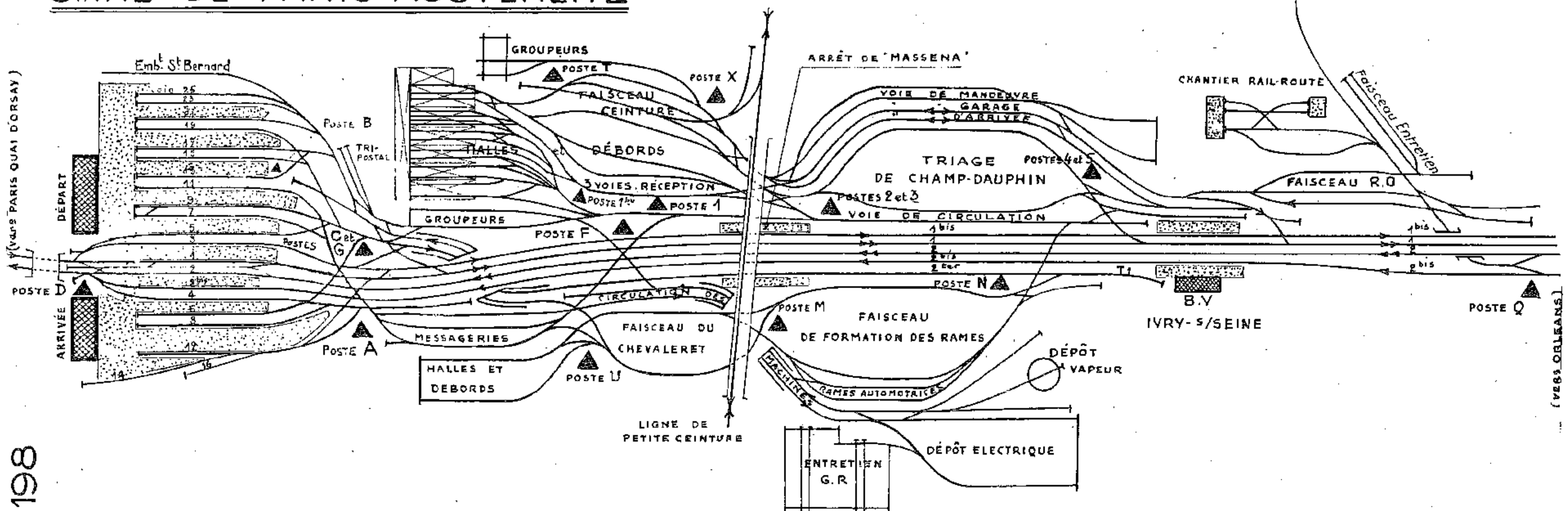

GARE DE TOURS-ST PIERRE-DES-CORPS

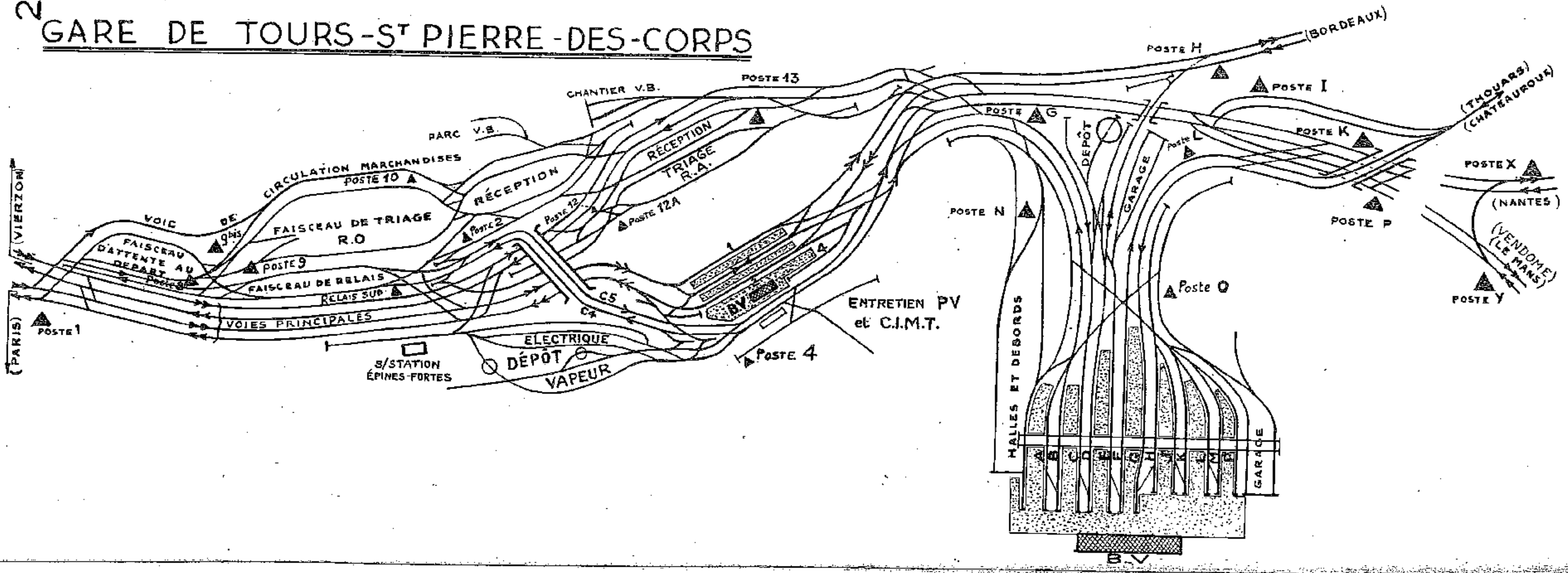

GARE DES AUBRAIS-ORLEANS

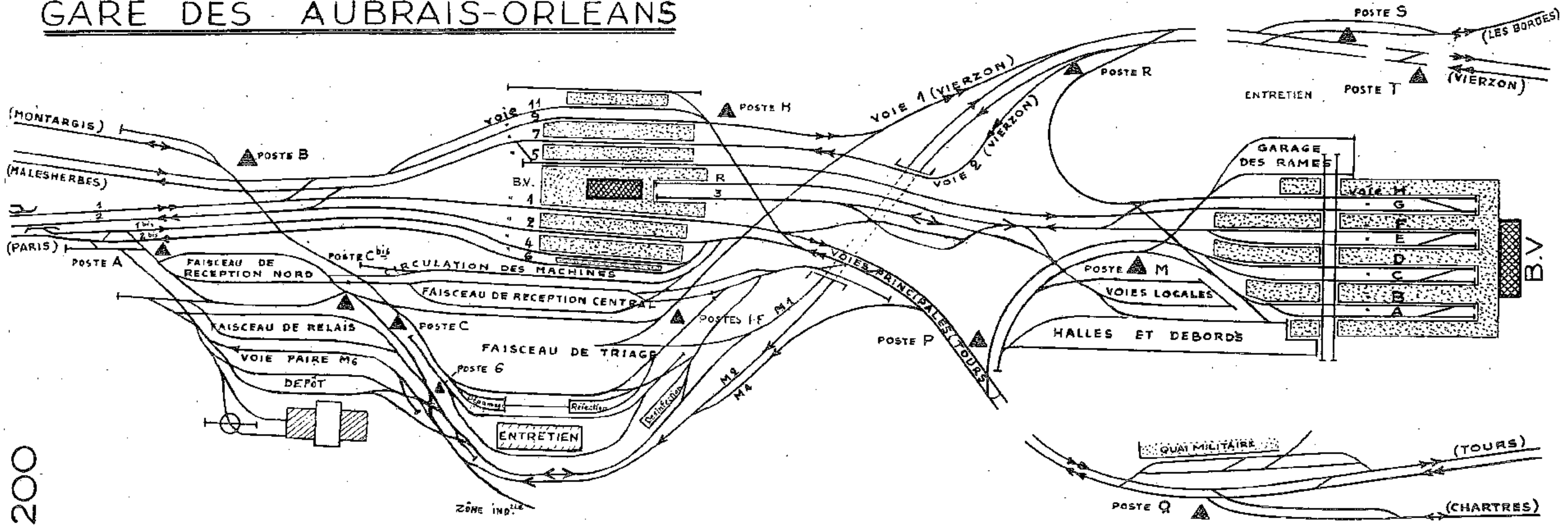

GARES DE BORDEAUX

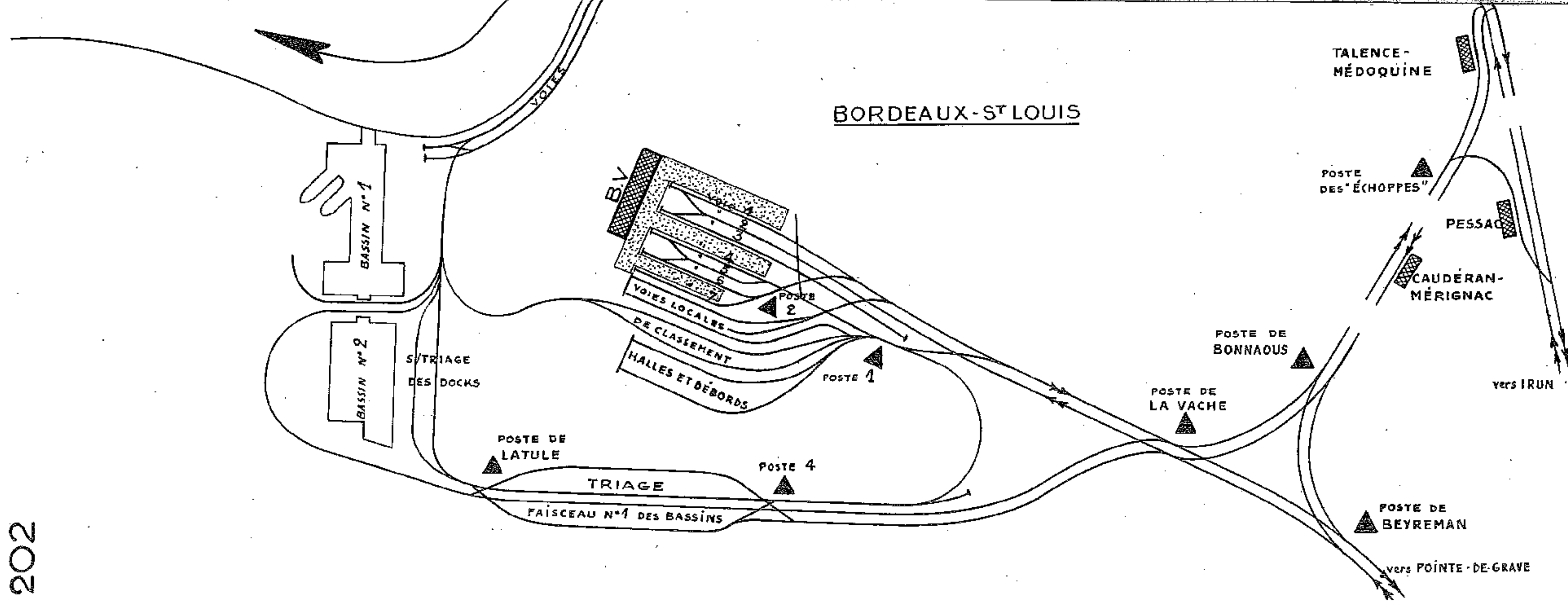
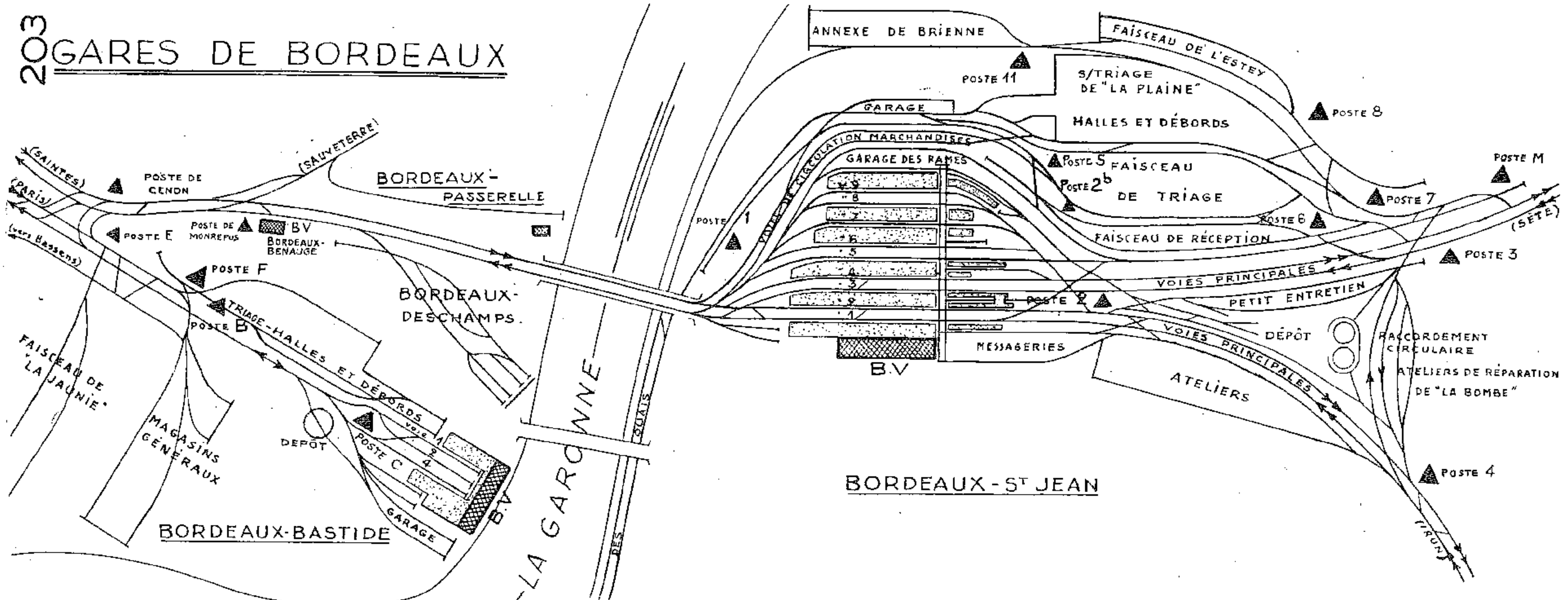

GARE DE BRIVE

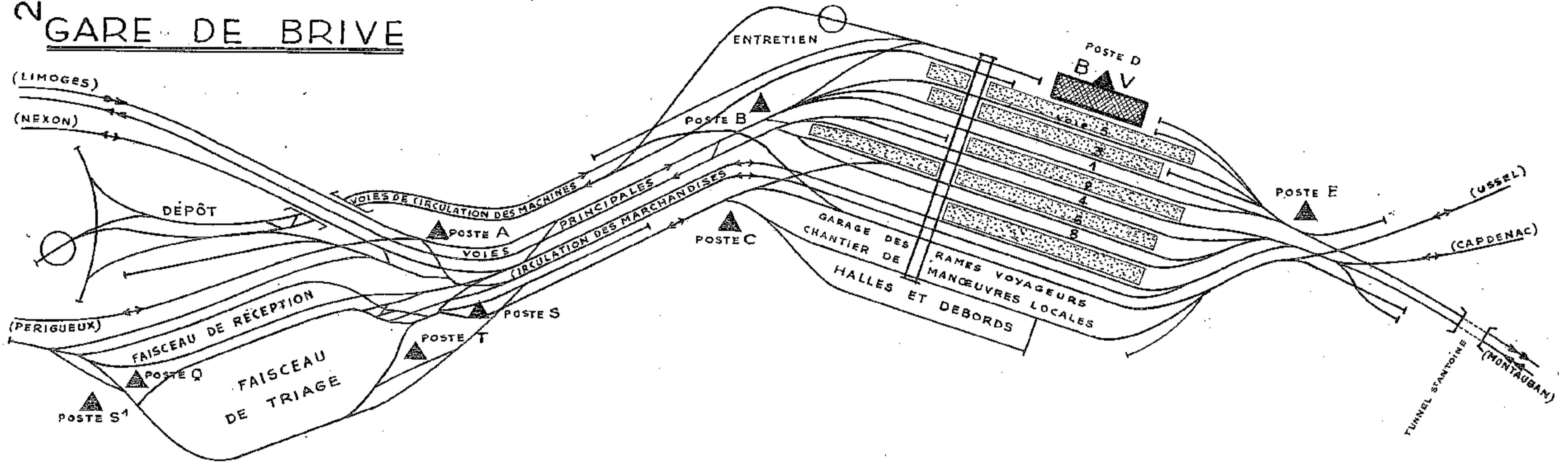

GARES DE LIMOGES

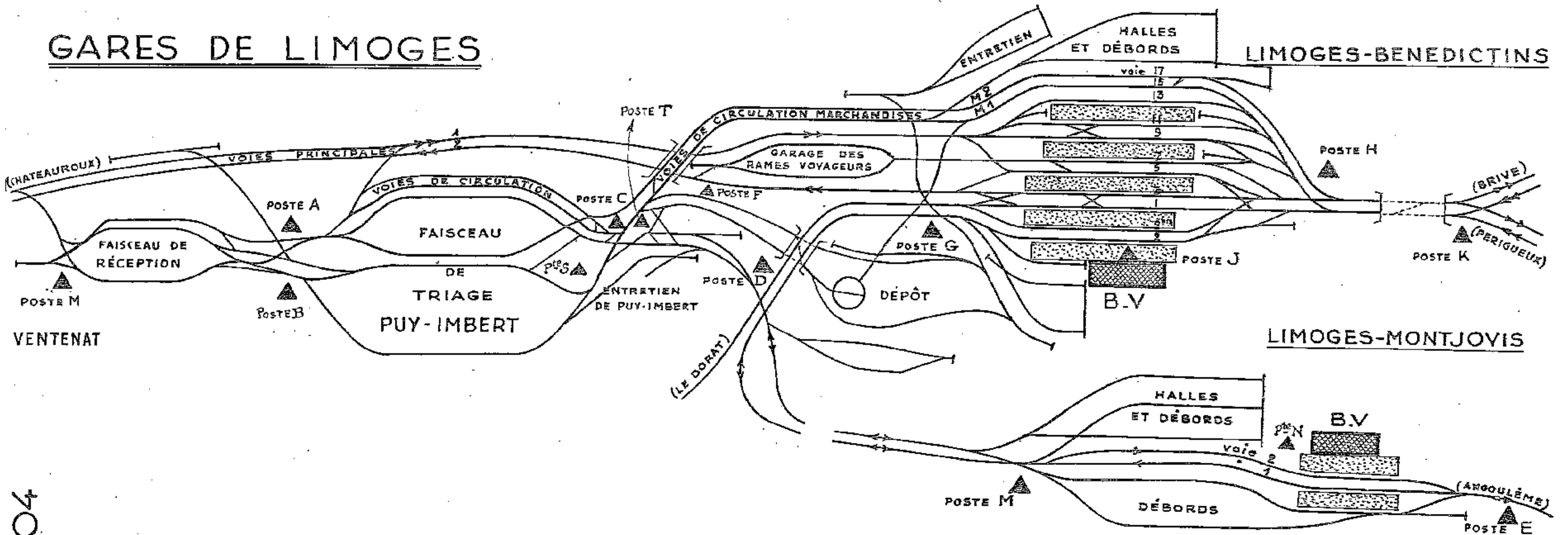

GARE DE TOULOUSE

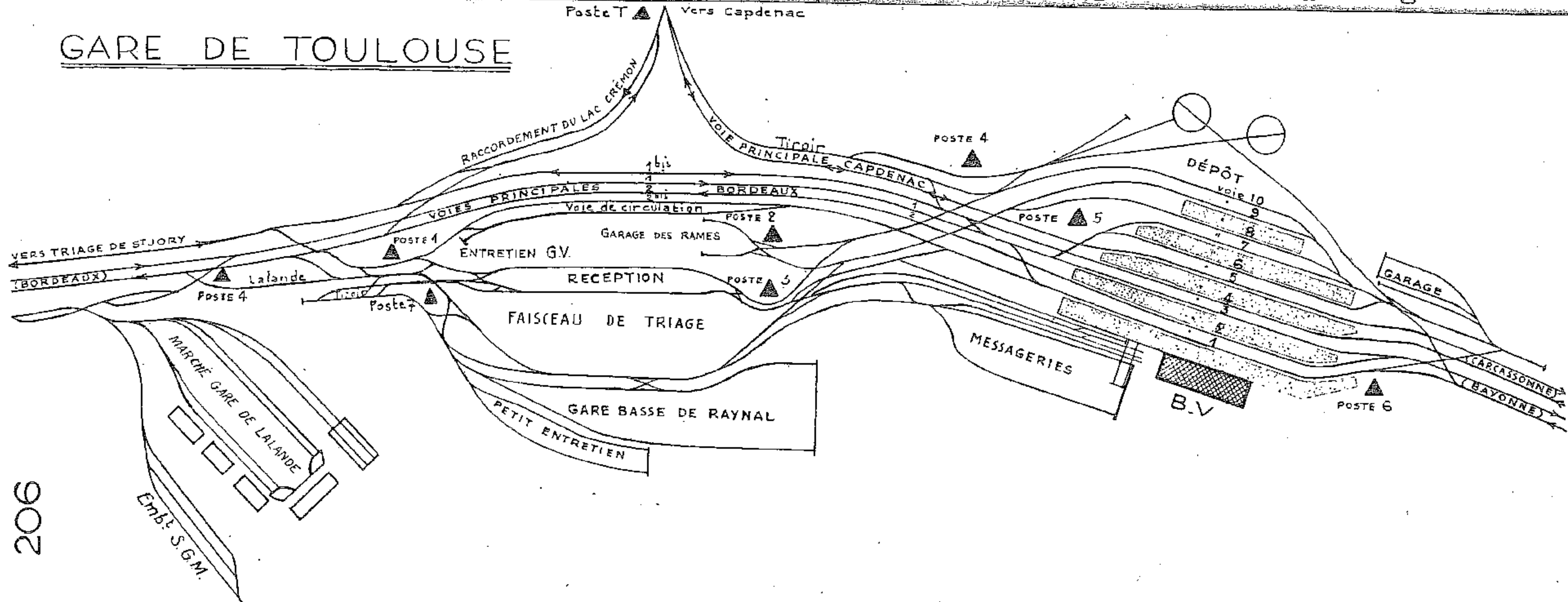

CHARTRES à SAINTES

Section Château-du-Loir à Saumur R.D.



Poste T
Vers Capdenac

Raccordement de Saumur R.G.

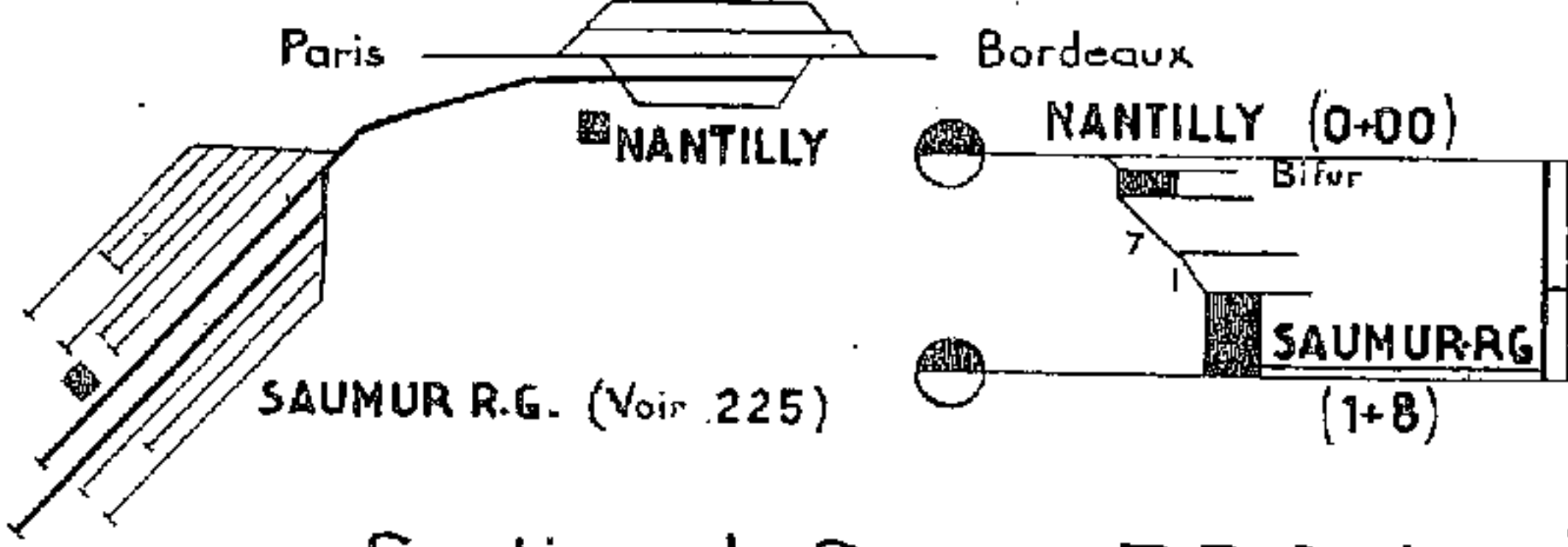

Section de Saumur R.D. à Thouars

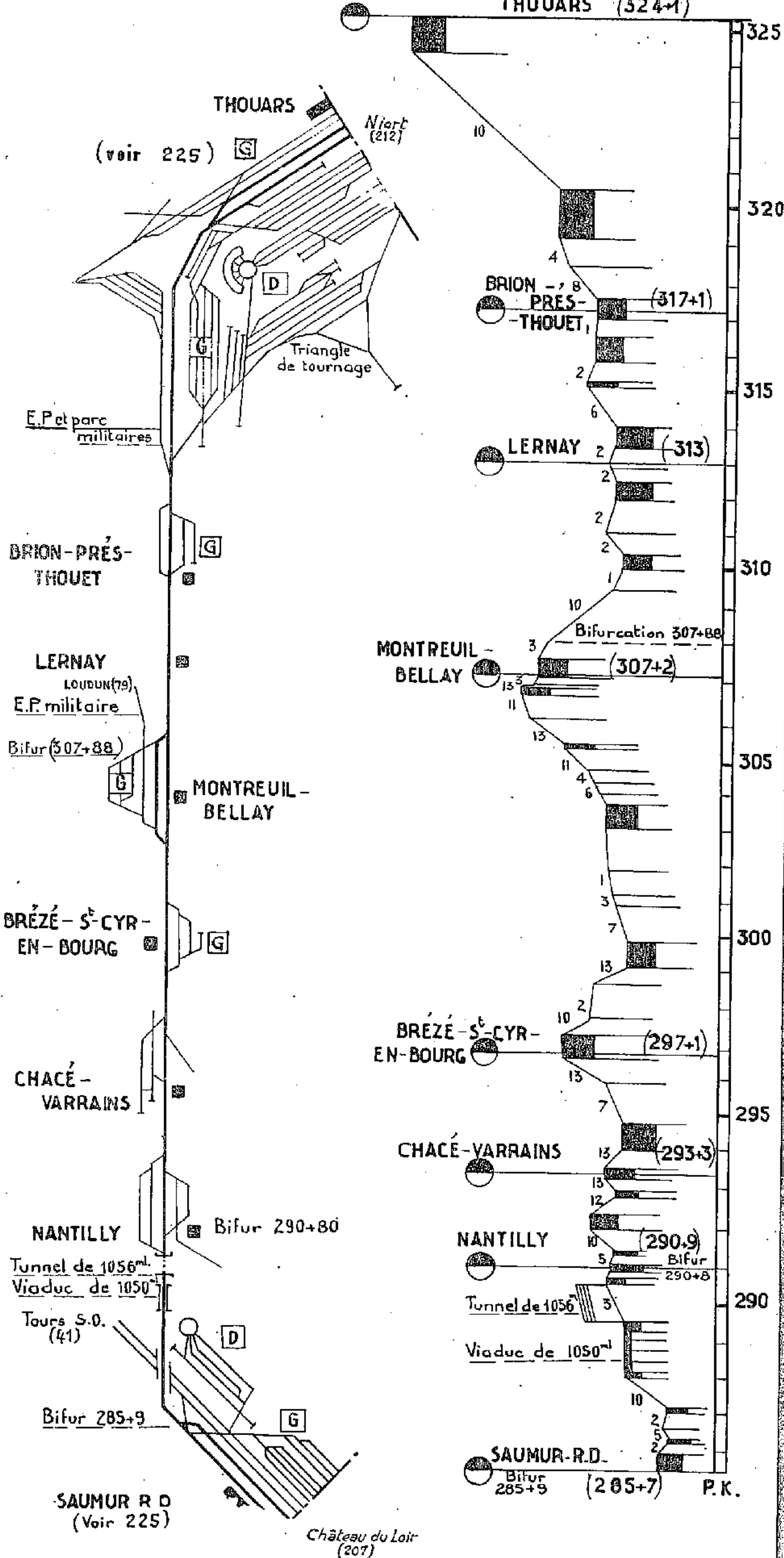

Section Angers-Nantes

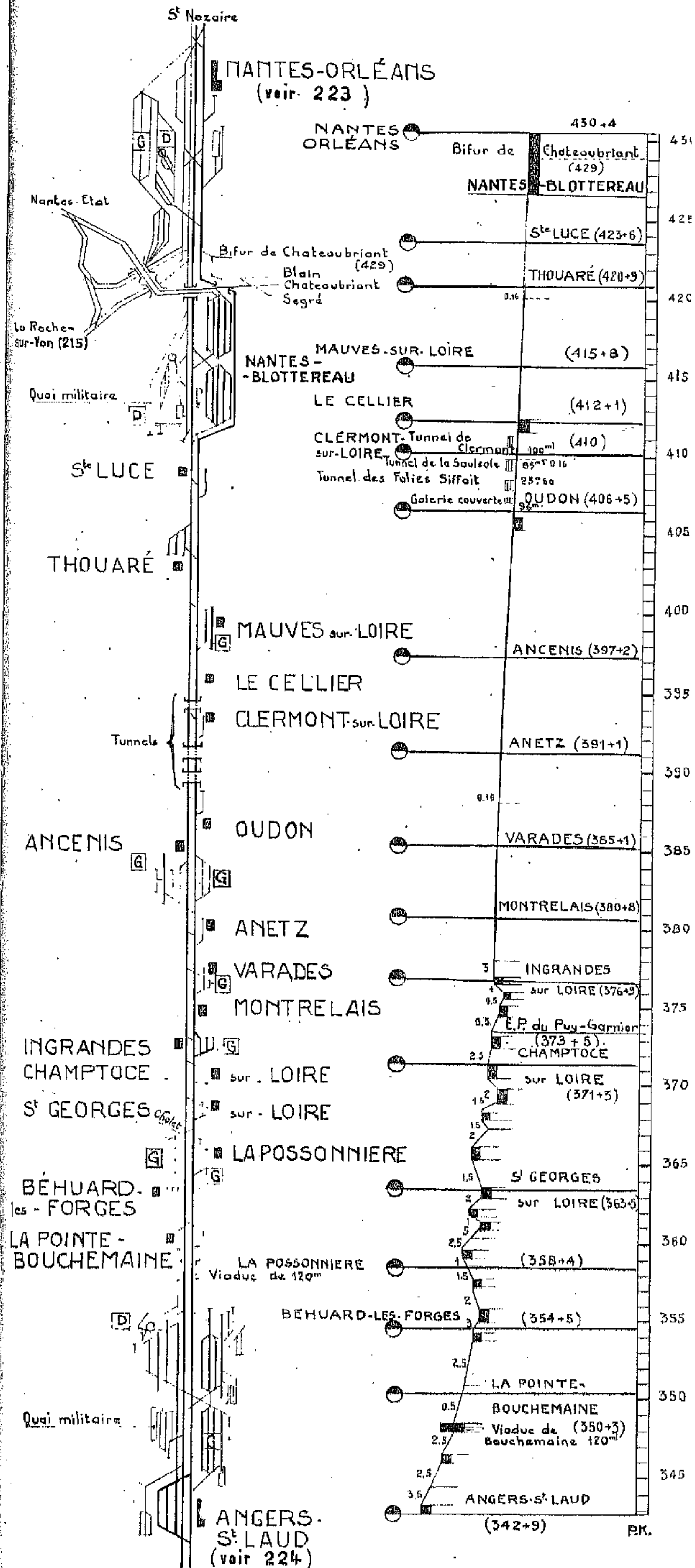

Section Poitiers-Niort

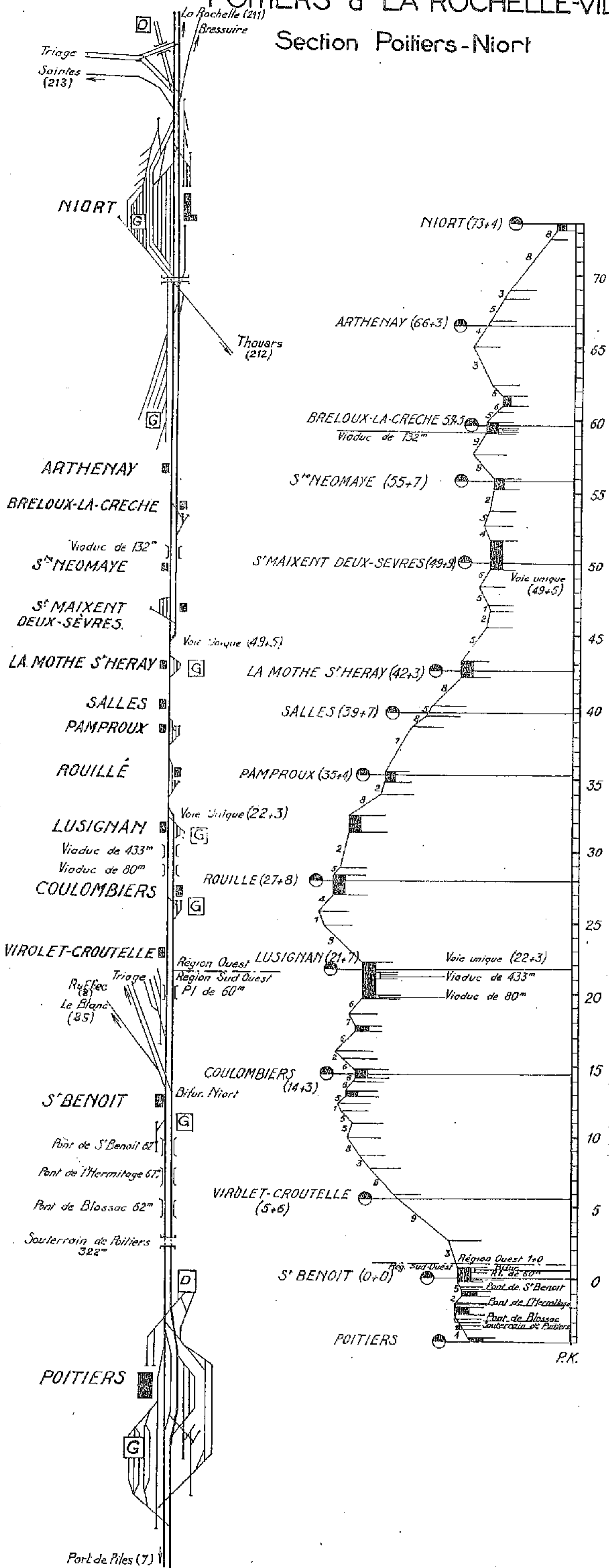

Section Niort la Rochelle-Ville

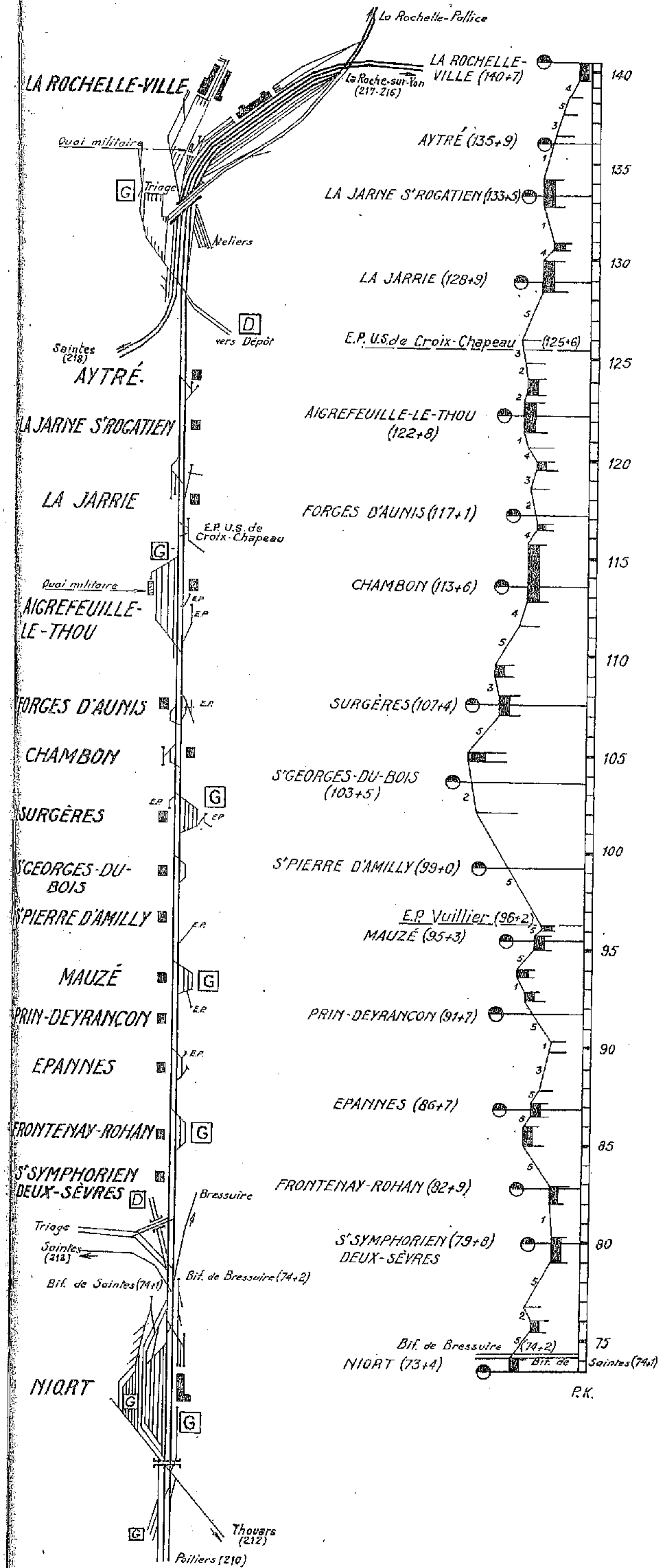

LIGNE de CHARTRES à SAINTES

Section de Thouars à Niort

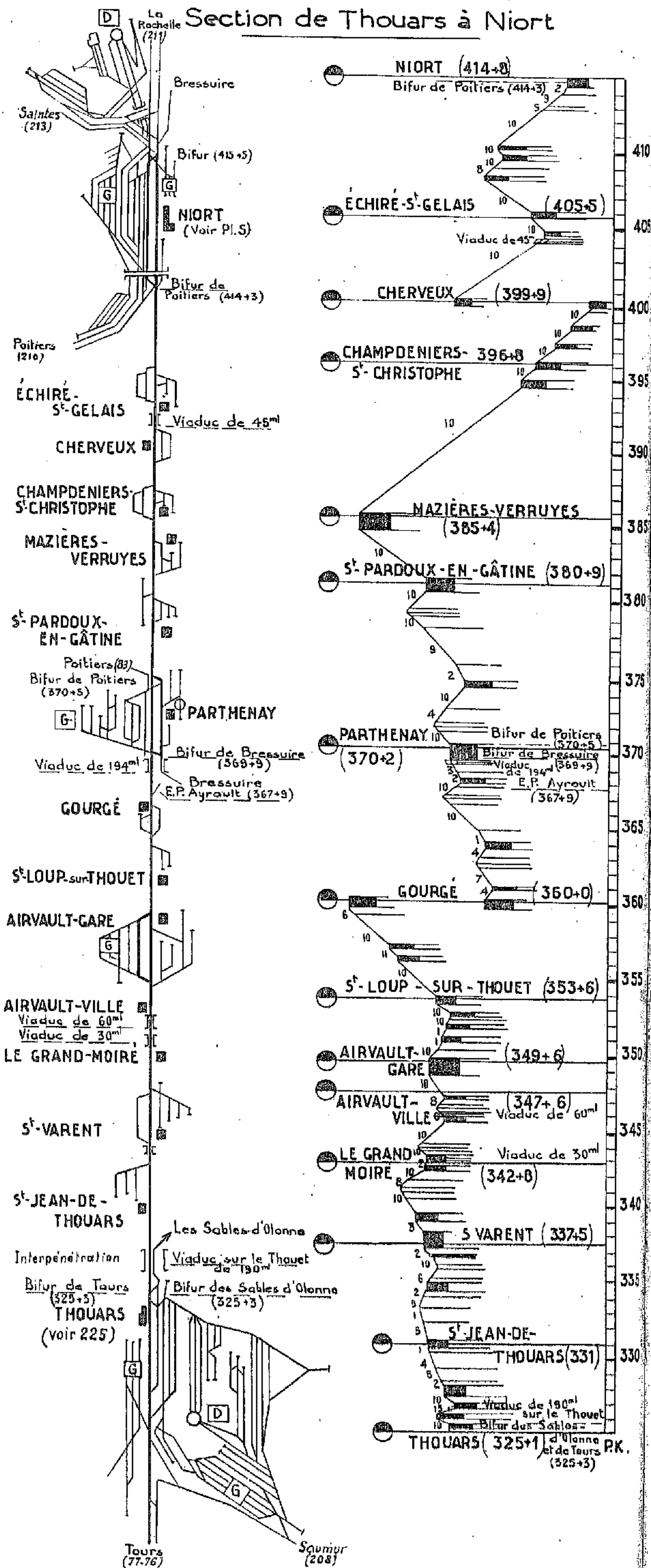

LIGNE de CHARTRES à SAINTES

Section de Niort à Saintes

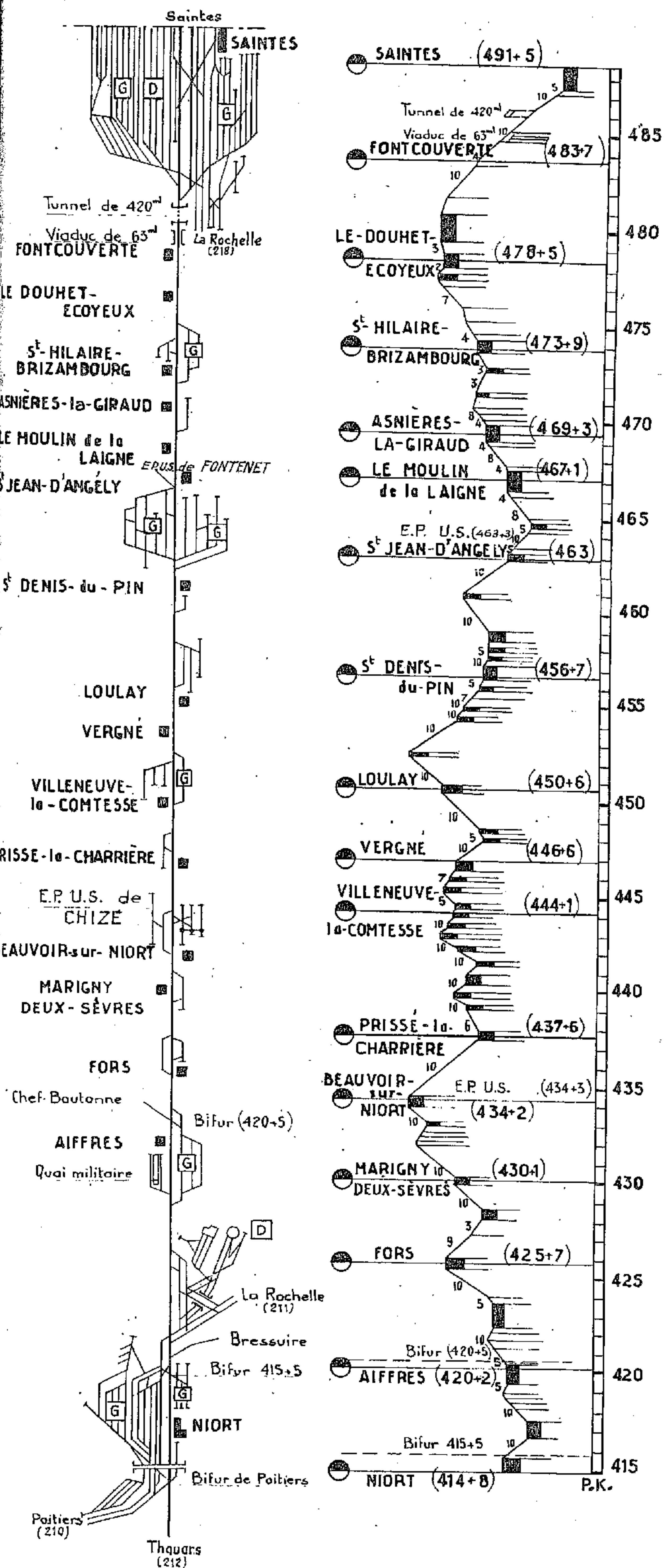

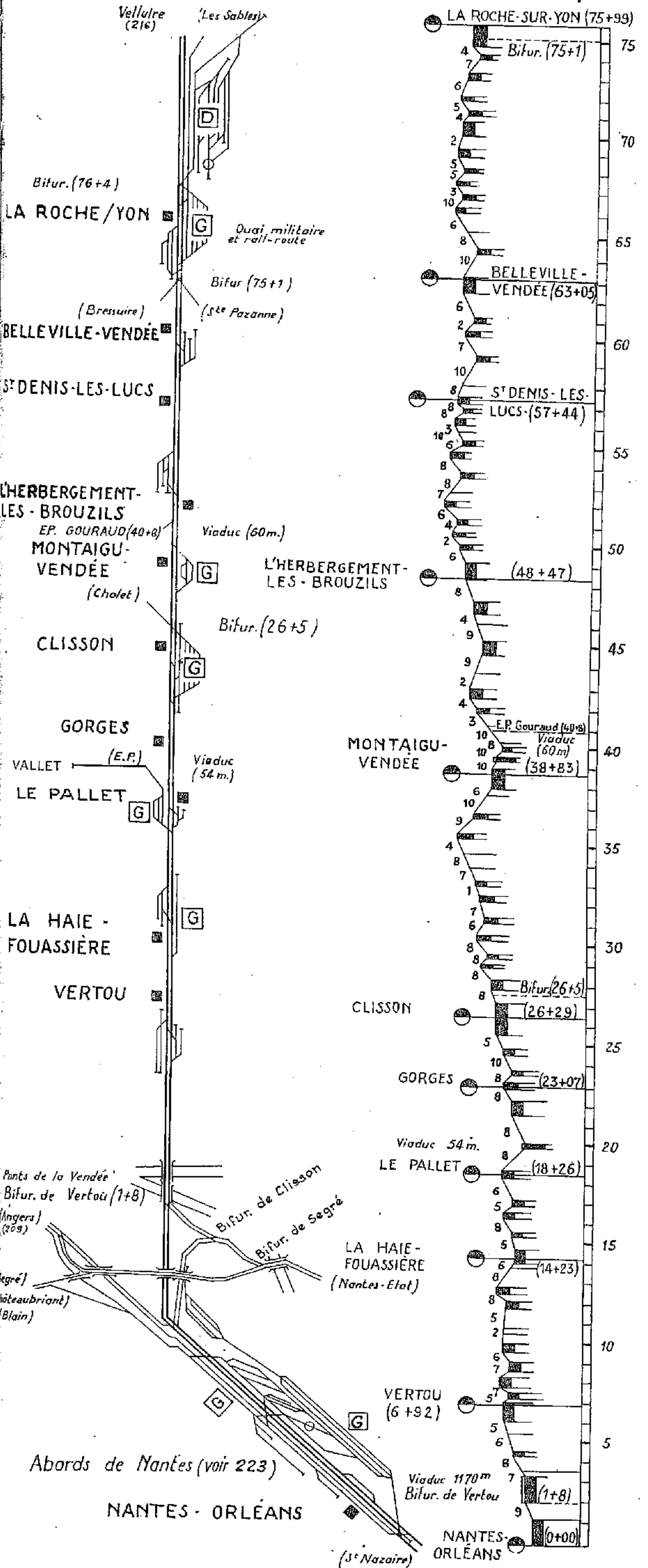
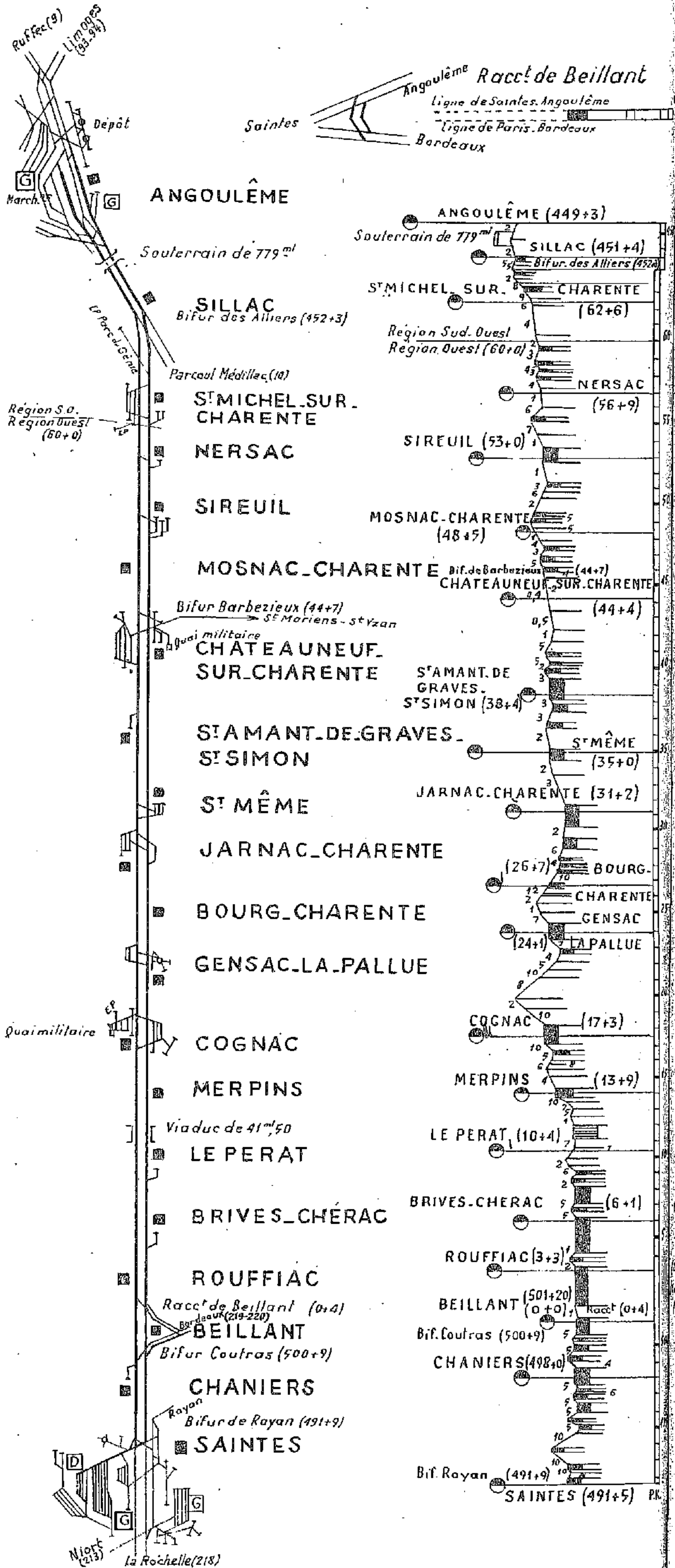

EMBRANCHEMENT du PORT de LUÇON

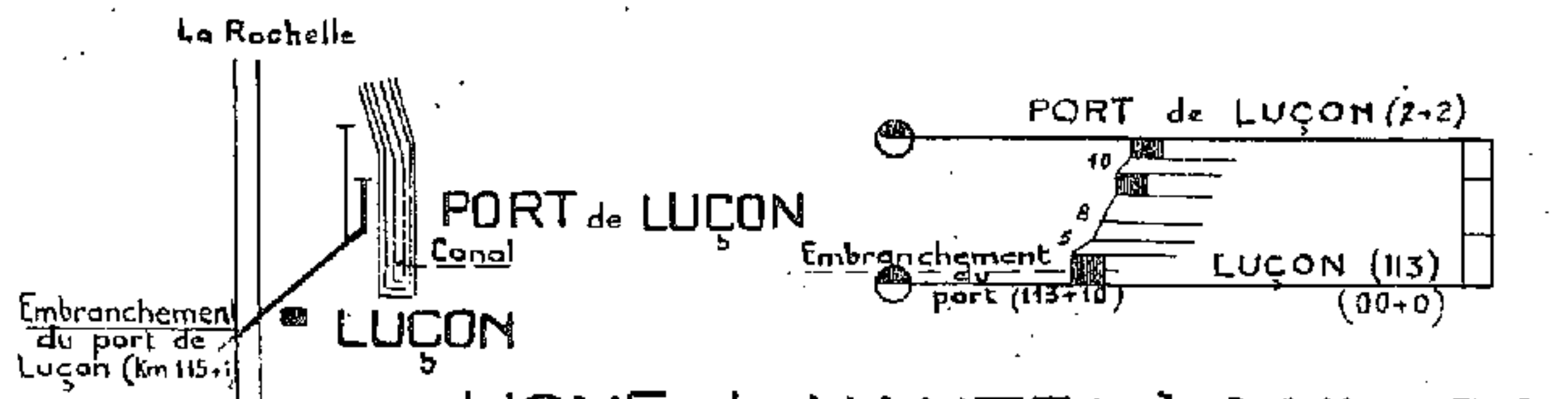

LIGNE de NANTES à SAINTES
Section La Roche-sur-Yon à Velluire

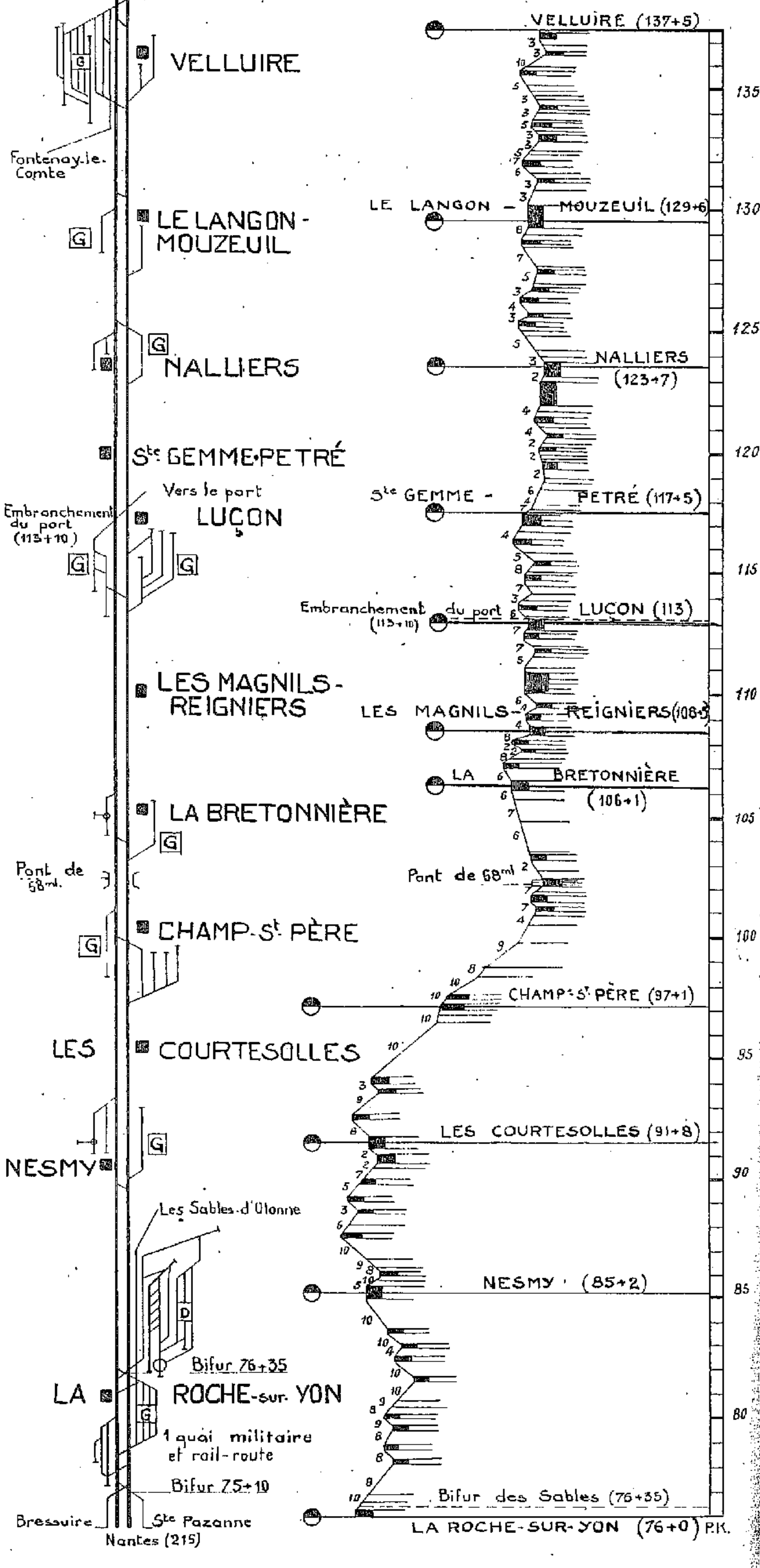

Section Velluire-la Rochelle

Embranchement de la Rochelle à la Rochelle-Pallice

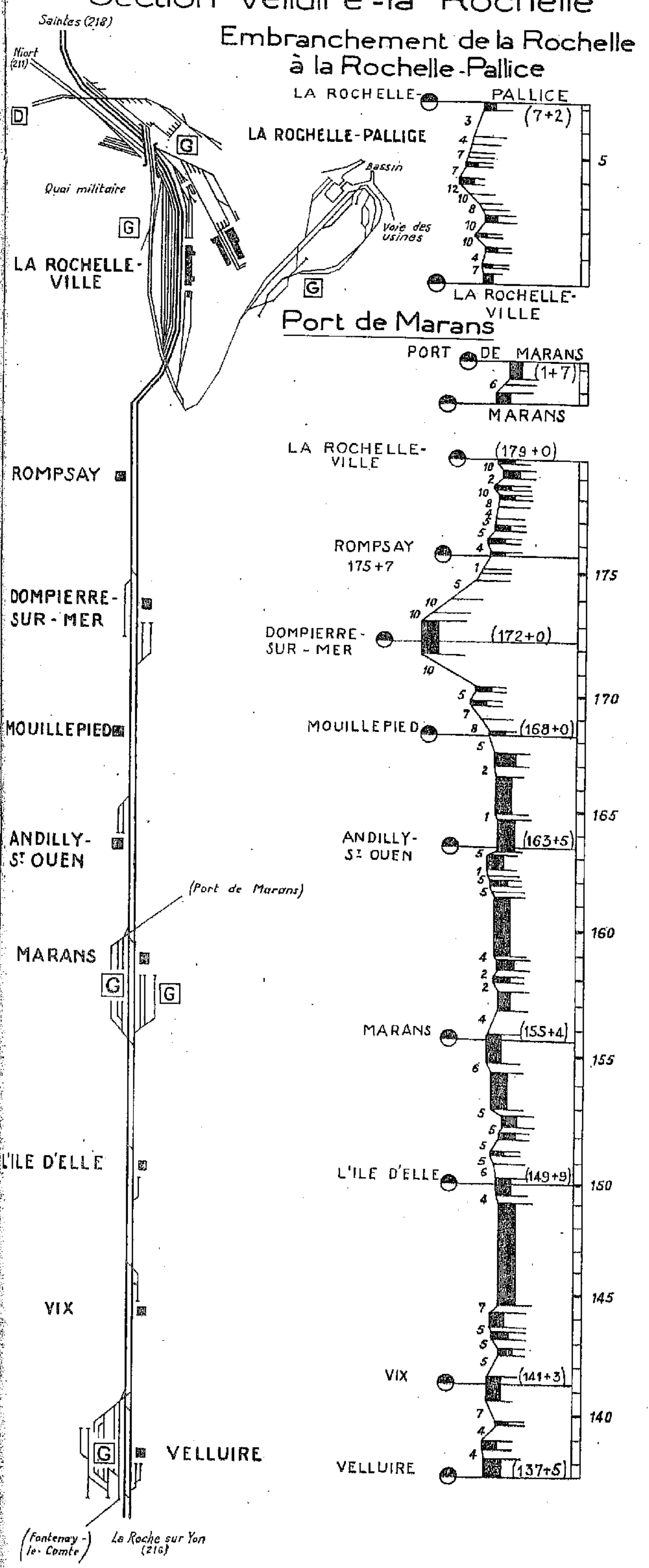

Section la Rochelle-Ville-Saintes

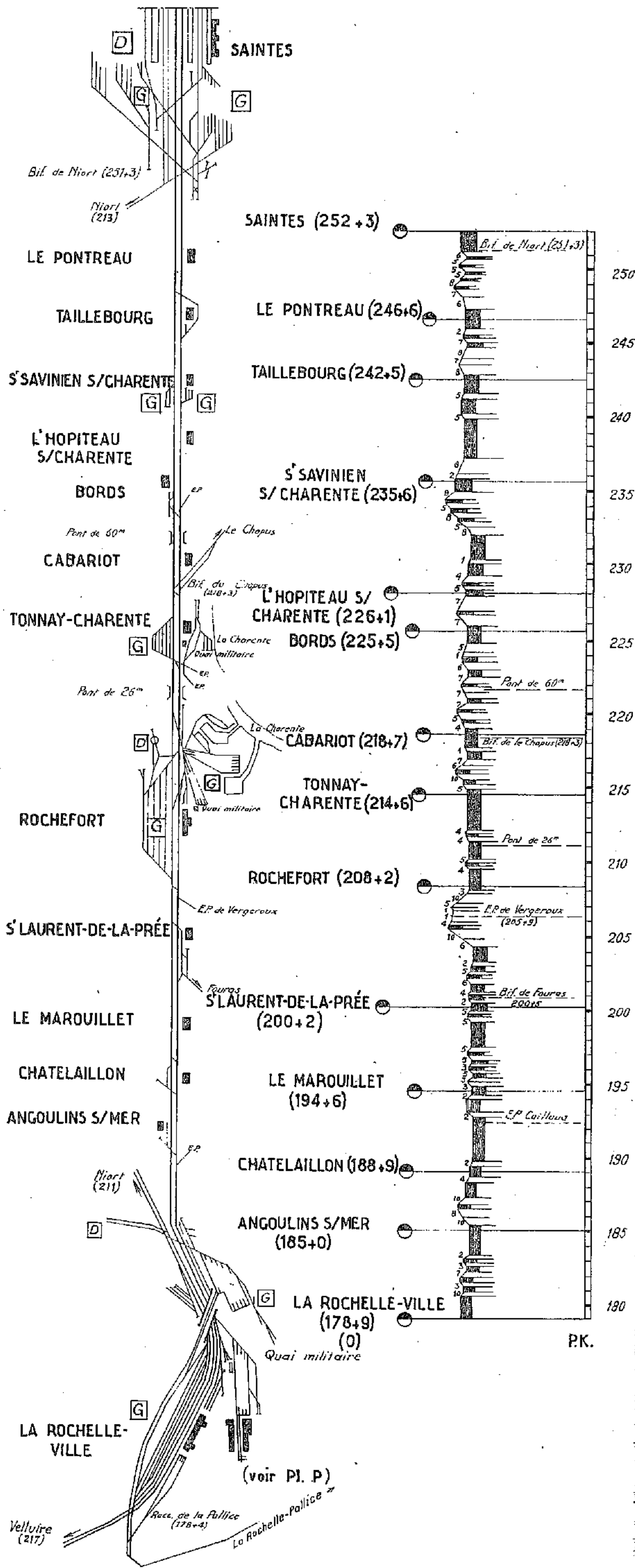

LIGNE de SAINTES-BORDEAUX

Section de Saintes à St Mariens-St Yzan

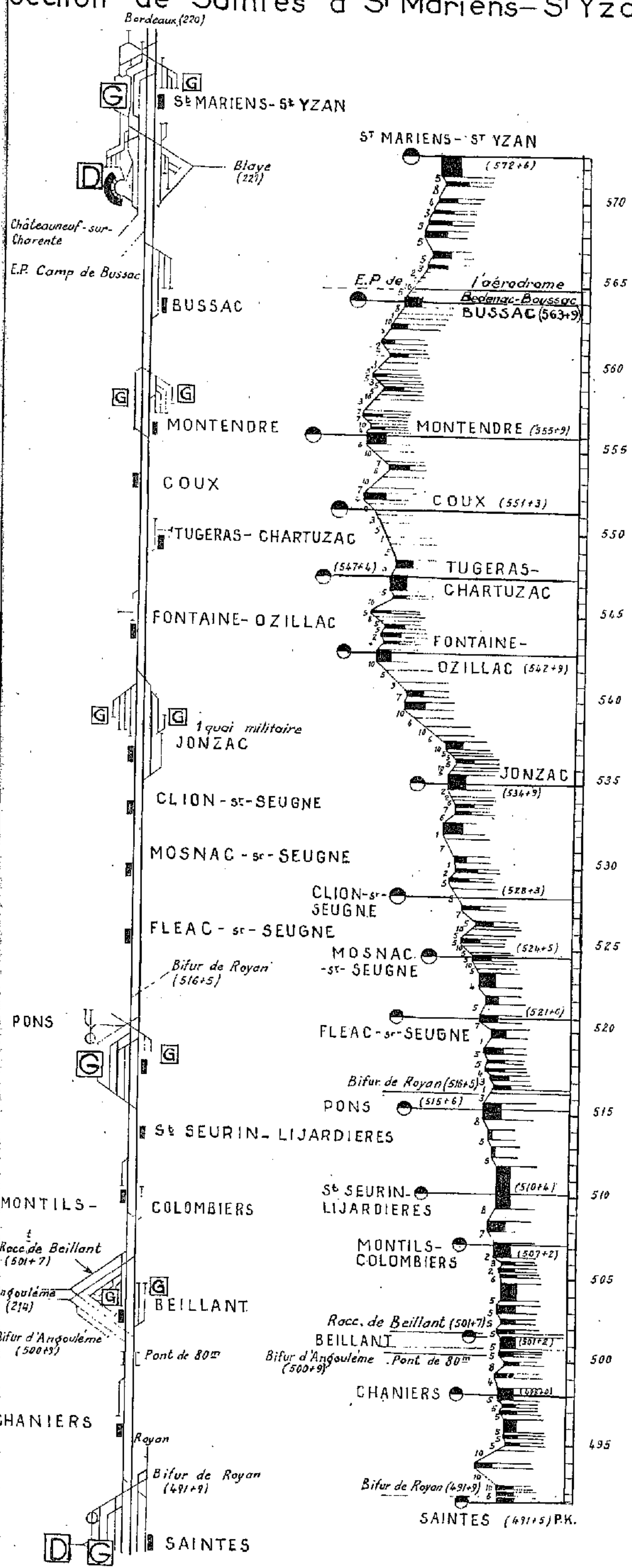

220 LIGNE de SAINTES, BORDEAUX
Section de St Mariens-St Yzan à Bordeaux

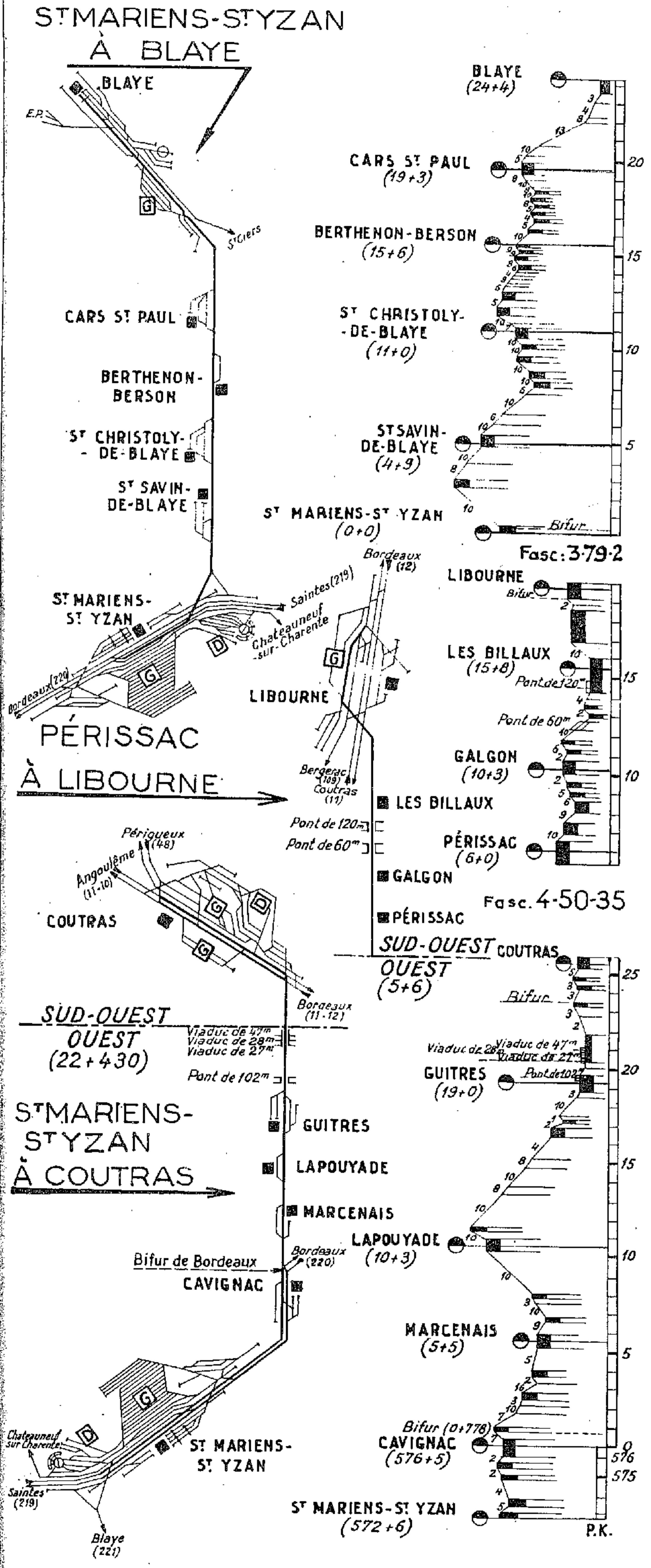
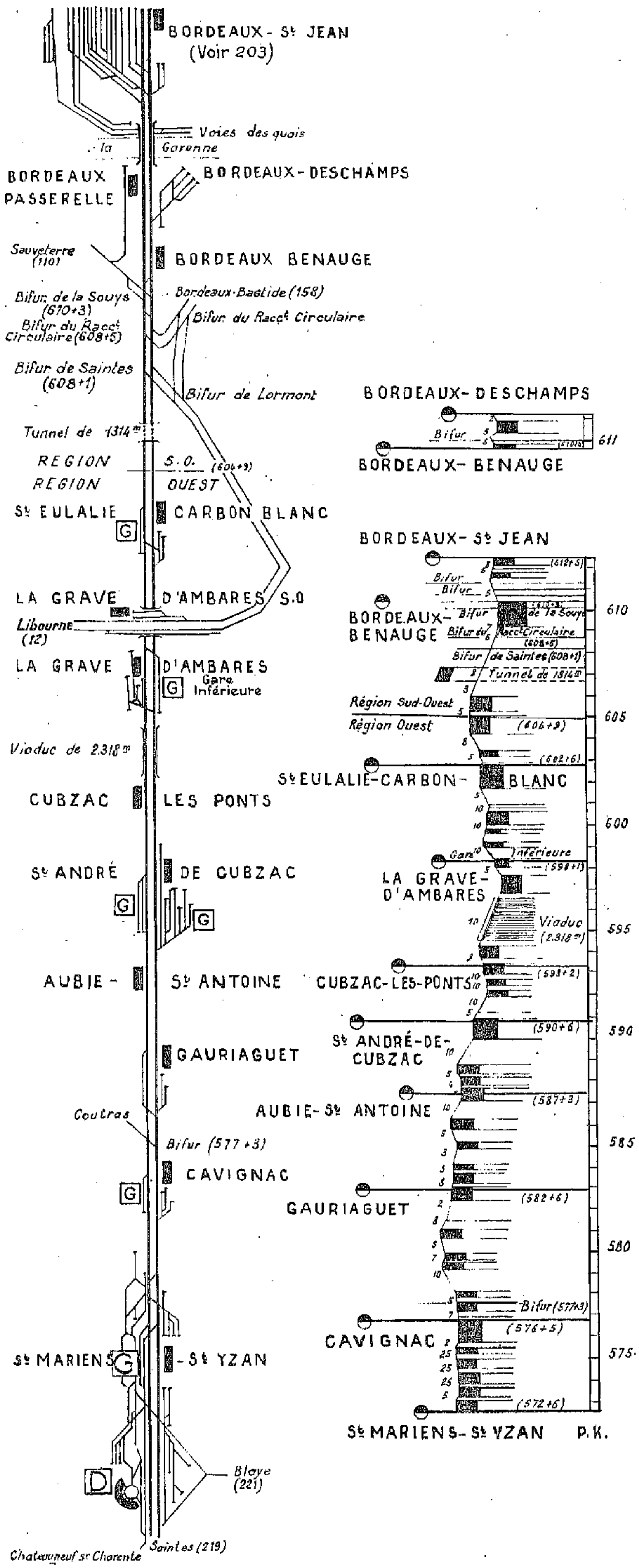

Brest

LAVERRIÈRE

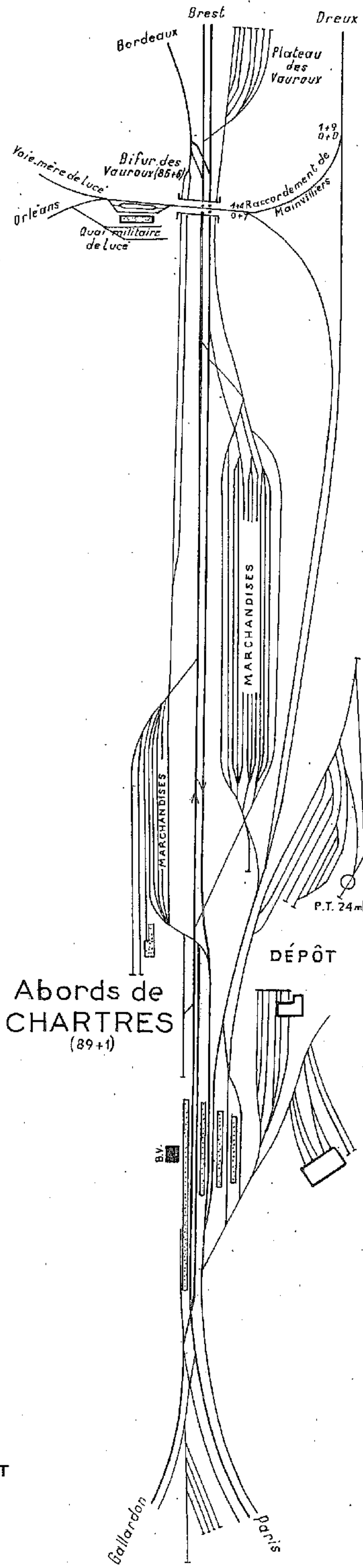
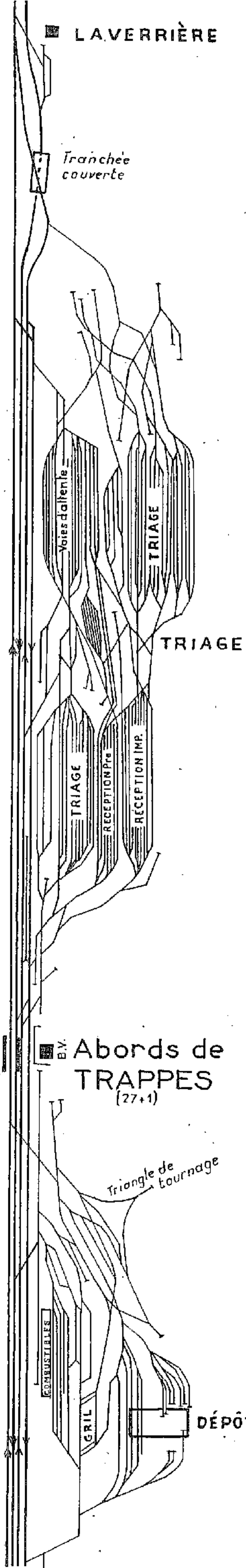

NANTES

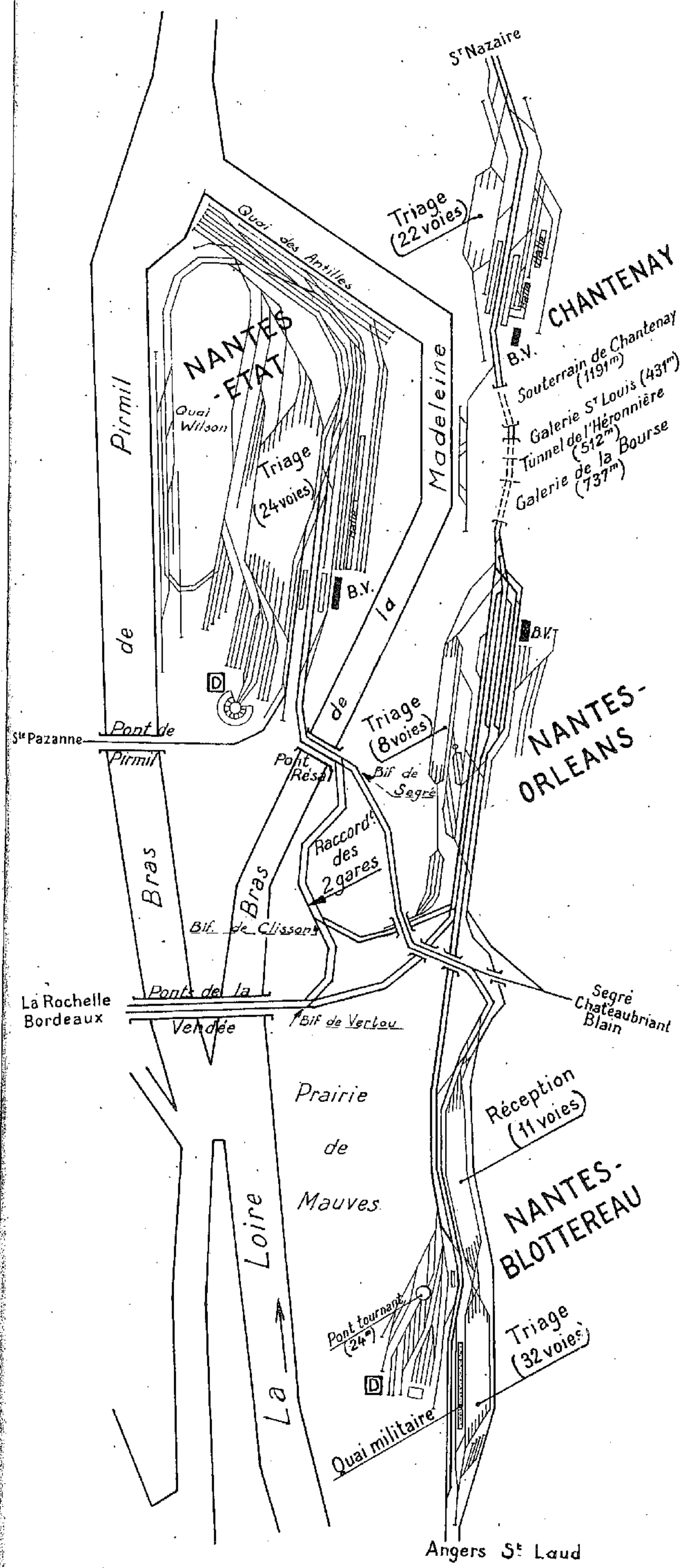

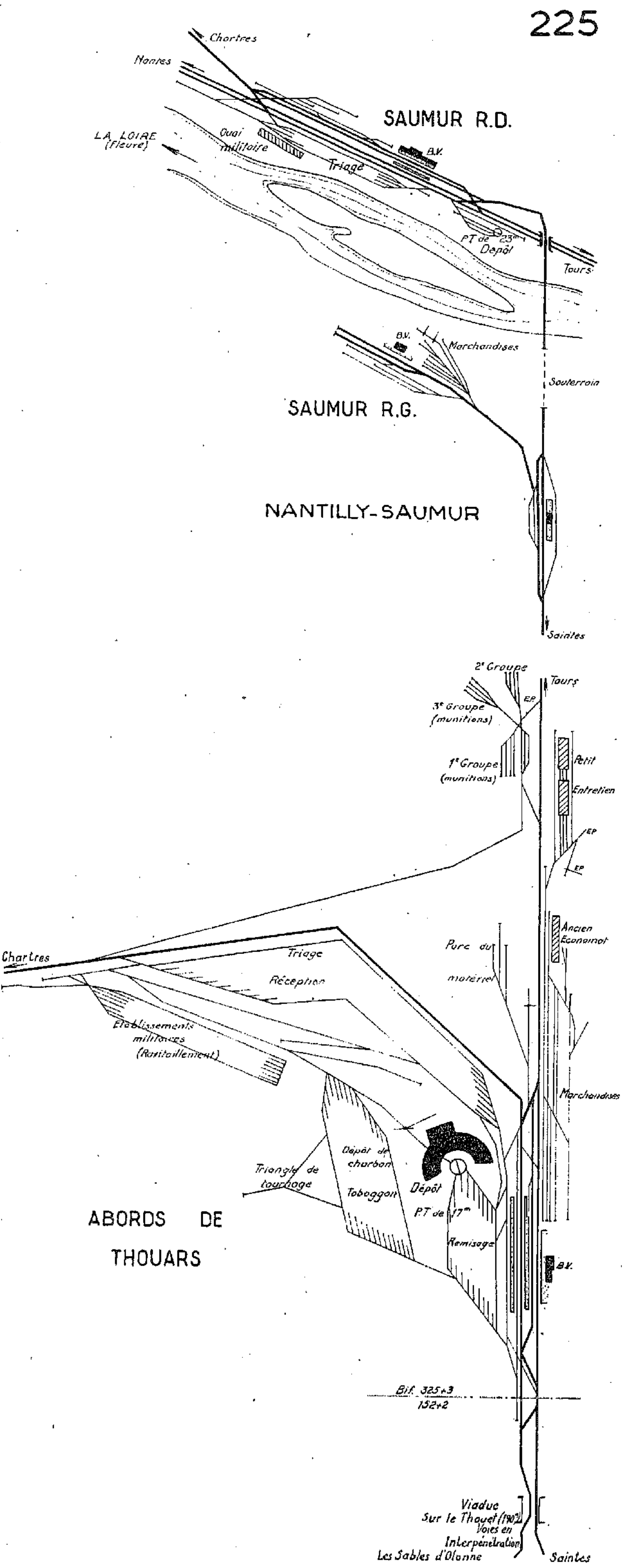
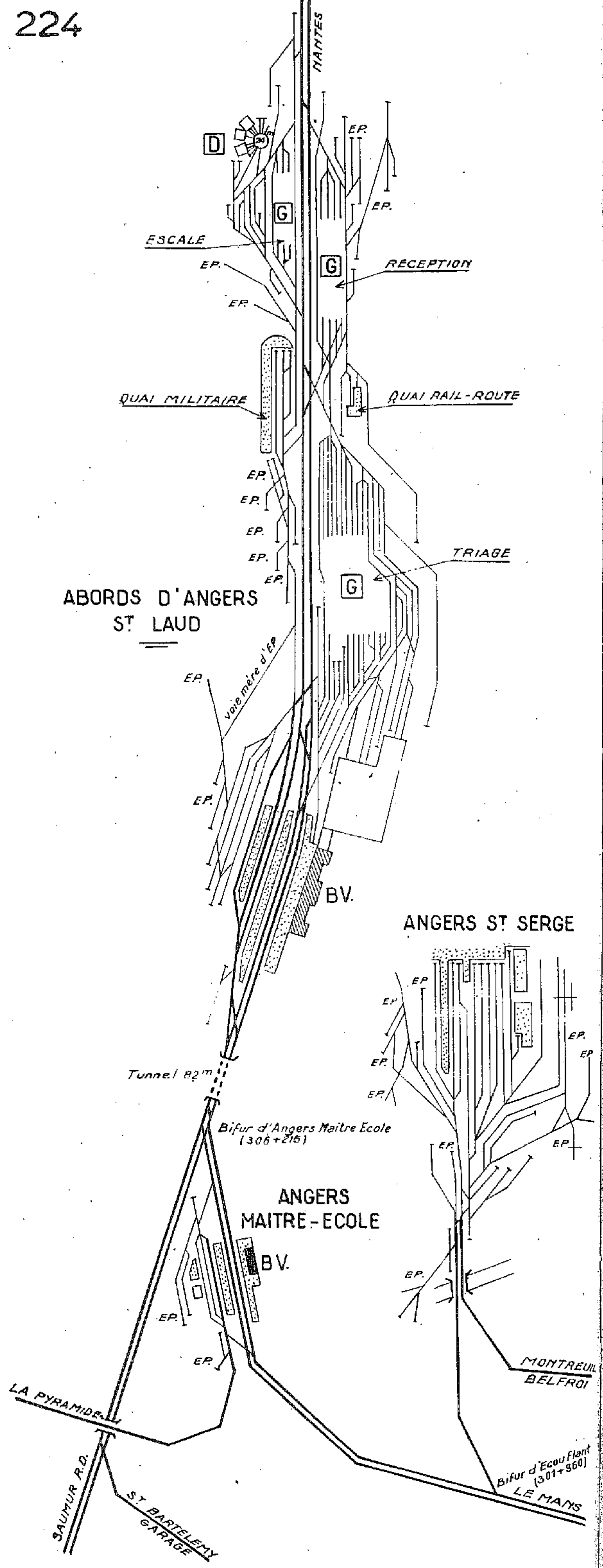

(Versailles)

CLAMART

(Montrouge-Chatillon) A B

VANVES-MALAKOFF

P.S. de 10 m.

Abords de MONTRouGE-CHATILLON

Locations

E.P.

Petit entretien

Ceinture

OUEST-CEINTURE

P.S. de 10 m.

Locations

E.P.

Voies de Formation et de lavage

Voies de Depart G.V.

Marchandises

Rail-Route

Gril de classement

Rotonde pour 18 machines

Rotonde pour 21 machines

Dépôt

Chantier de combustibles

A (Paris) B

Rail-Route

VAUGIRARD-MARCHANDISES

Pont du

Chateau

MAINE-DÉPART

MAINE-ARRIVÉE

Abords de PARIS - MONT PARNASSE

PARIS- MONT PARNASSE



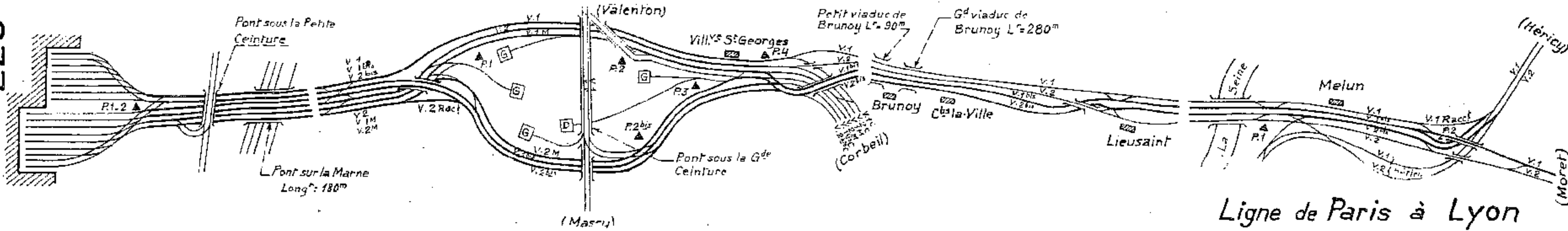

Ligne de Paris à Lyon
 Section de Paris à Melun -
 V.1 et V.2

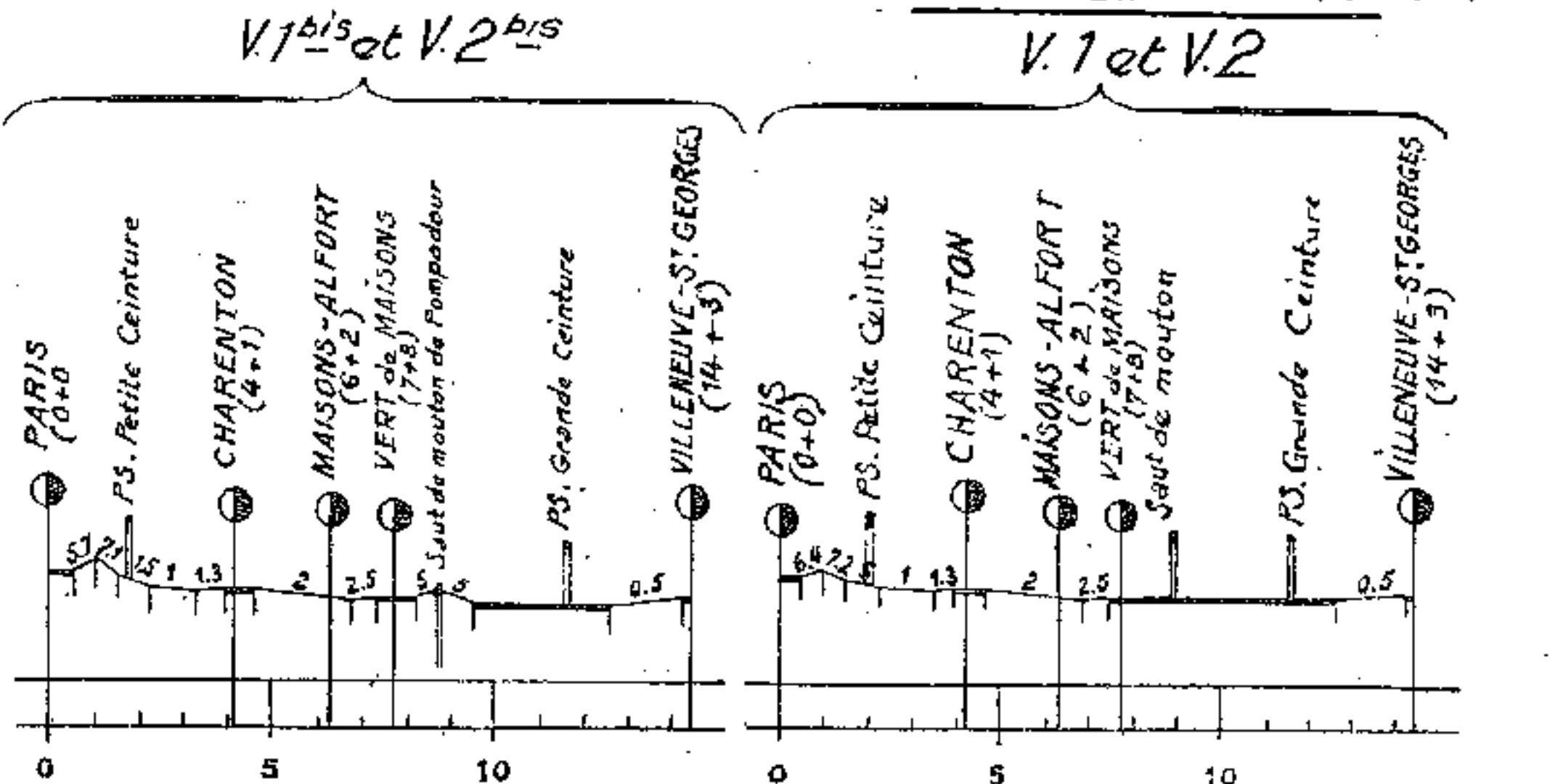
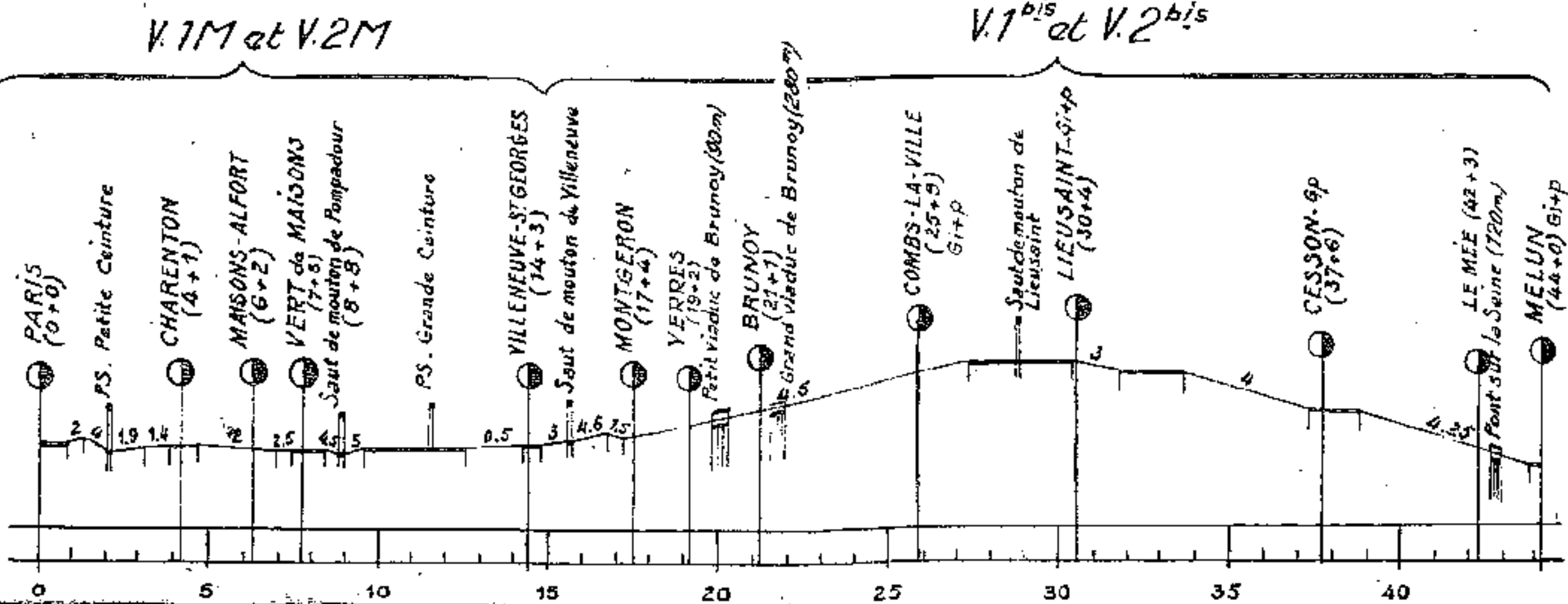

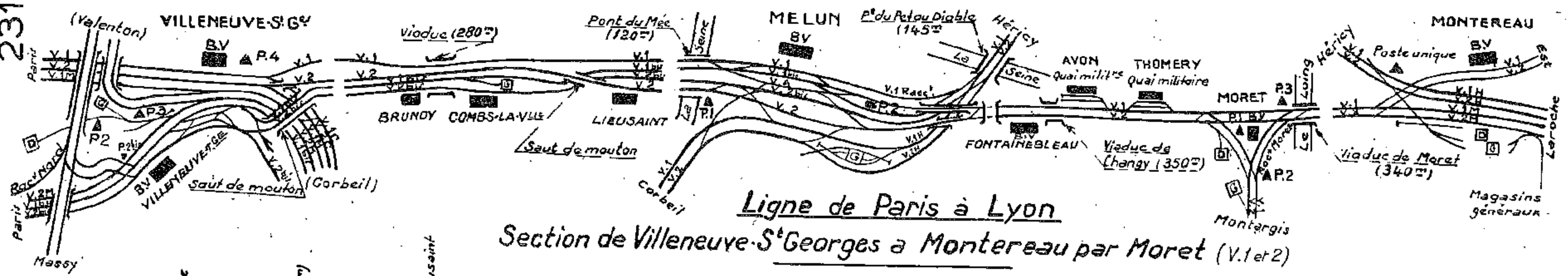

Ligne de Paris à Lyon
Section de Villeneuve-S^tGeorges à Montereau par Moret (V.1 et 2)

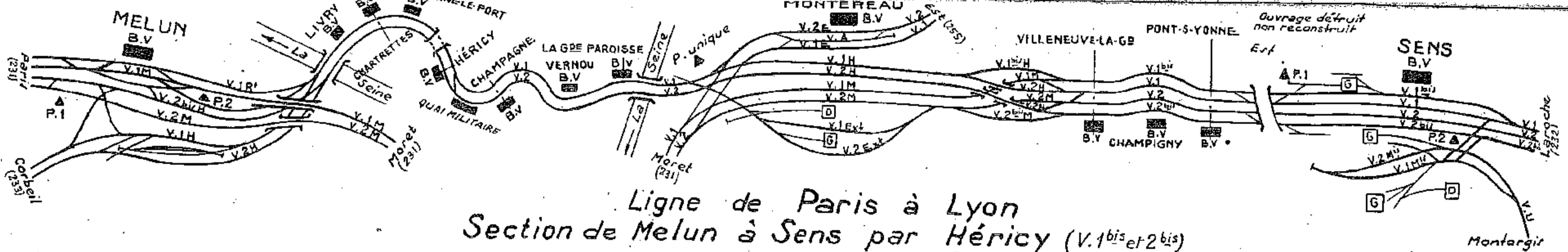
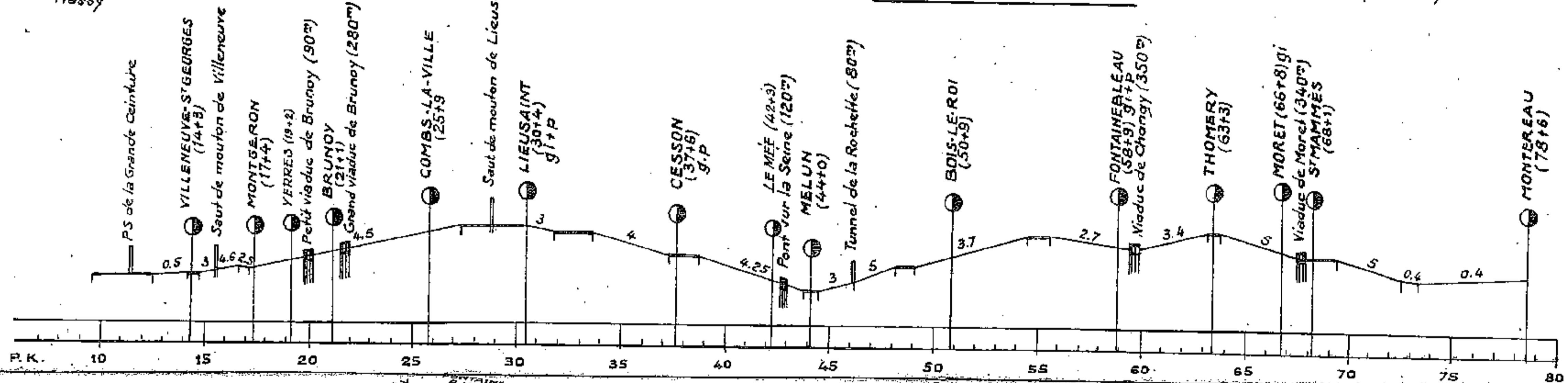

Ligne de Paris à Lyon
Section de Melun à Sens par Héricy (V.1 bis et 2 bis)

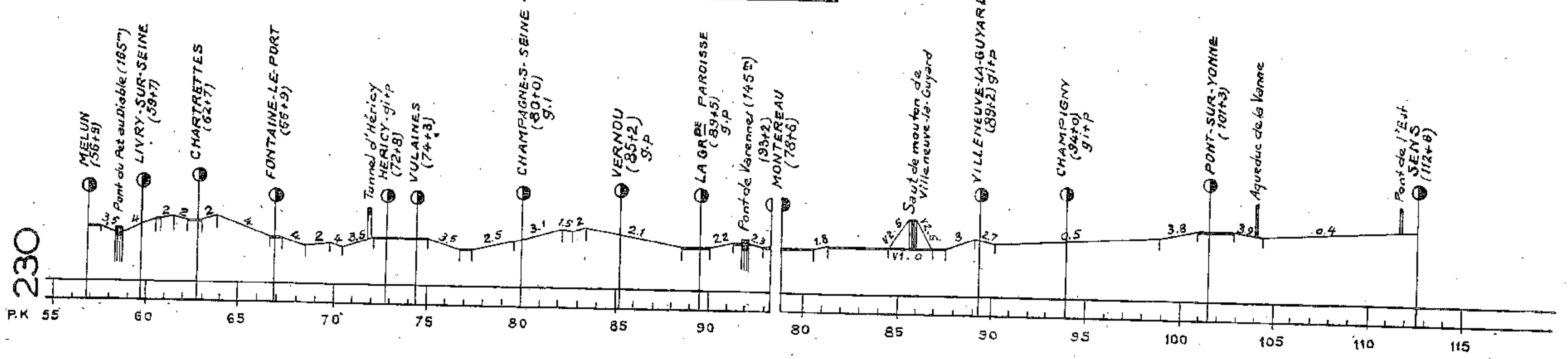

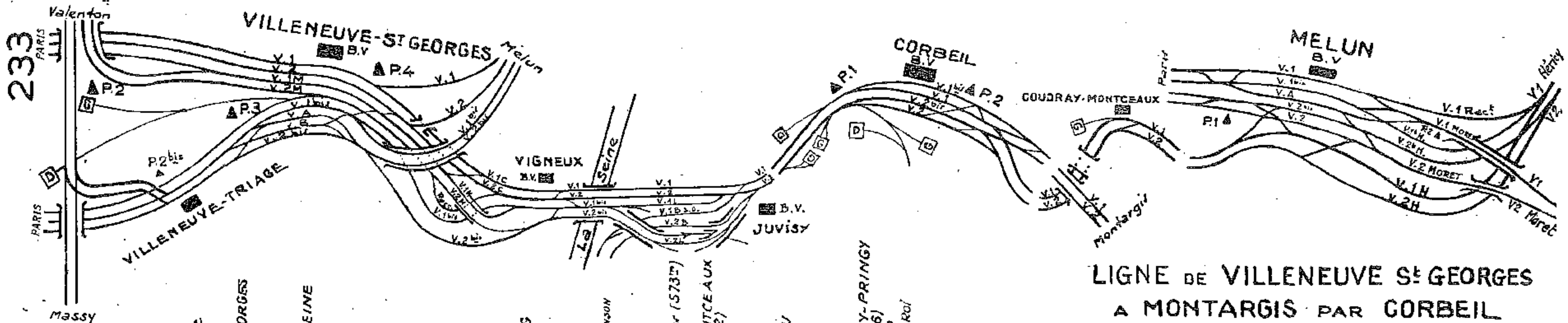

LIGNE DE VILLENEUVE S^t GEORGES
A MONTARGIS PAR CORBEIL
LIGNE DE CORBEIL A MELUN
ET A MONTEREAU

Section de Villeneuve S^t Georges
à Melun par Corbeil

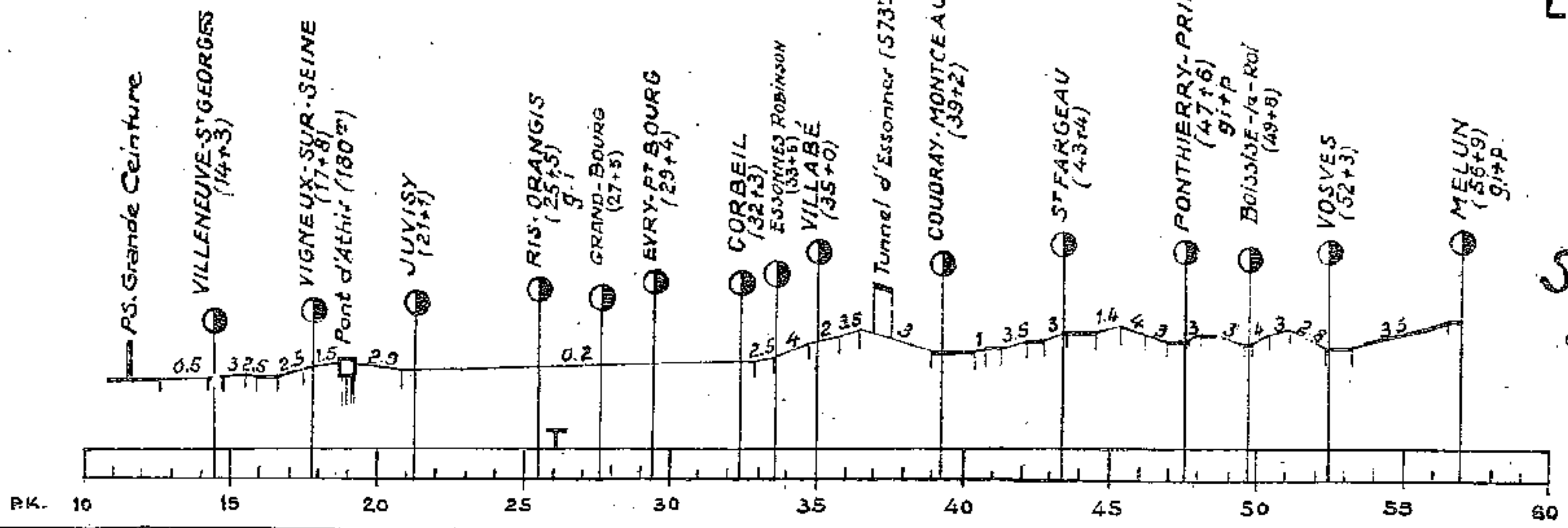

Ligne de Paris à Lyon.
Section de Montereau à Laroche. par V1 et 2

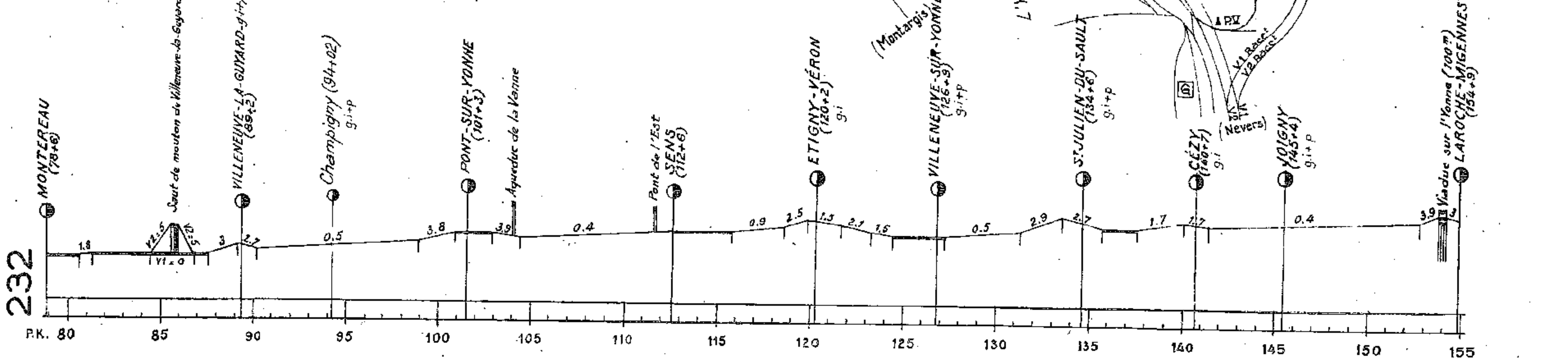
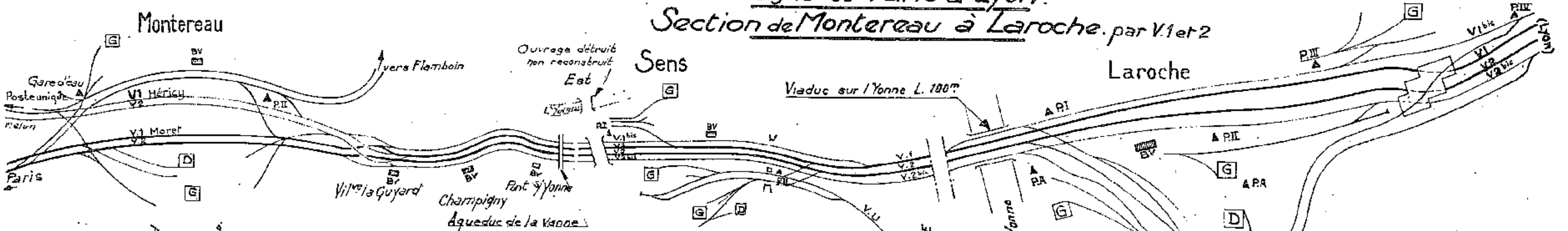

Ligne de Paris à Marseille - Ligne Moret à Roanne
Ligne de Bourron à Malesherbes.

Section de Montereau à Malesherbes - Raccords de Moret et de Filay:

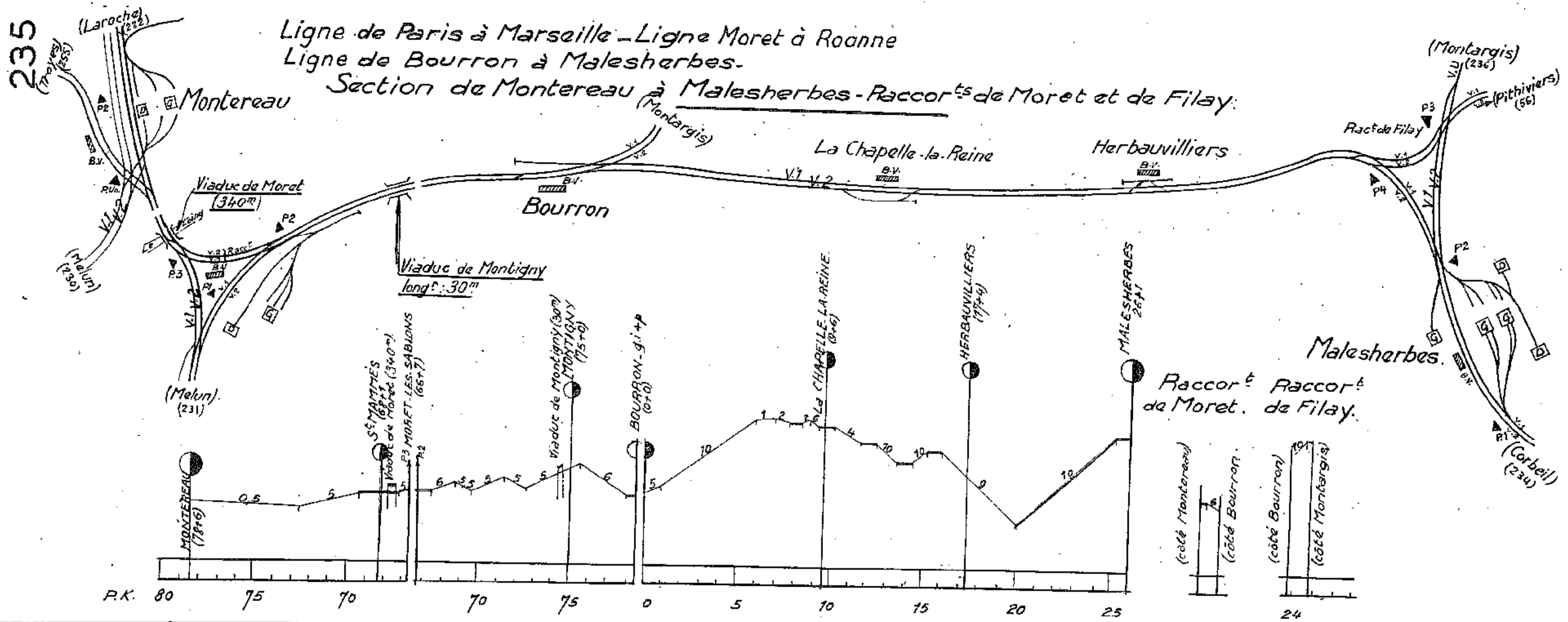

Ligne de Villeneuve St-Georges à Montargis par Corbeil.

Section de Corbeil à Malesherbes.

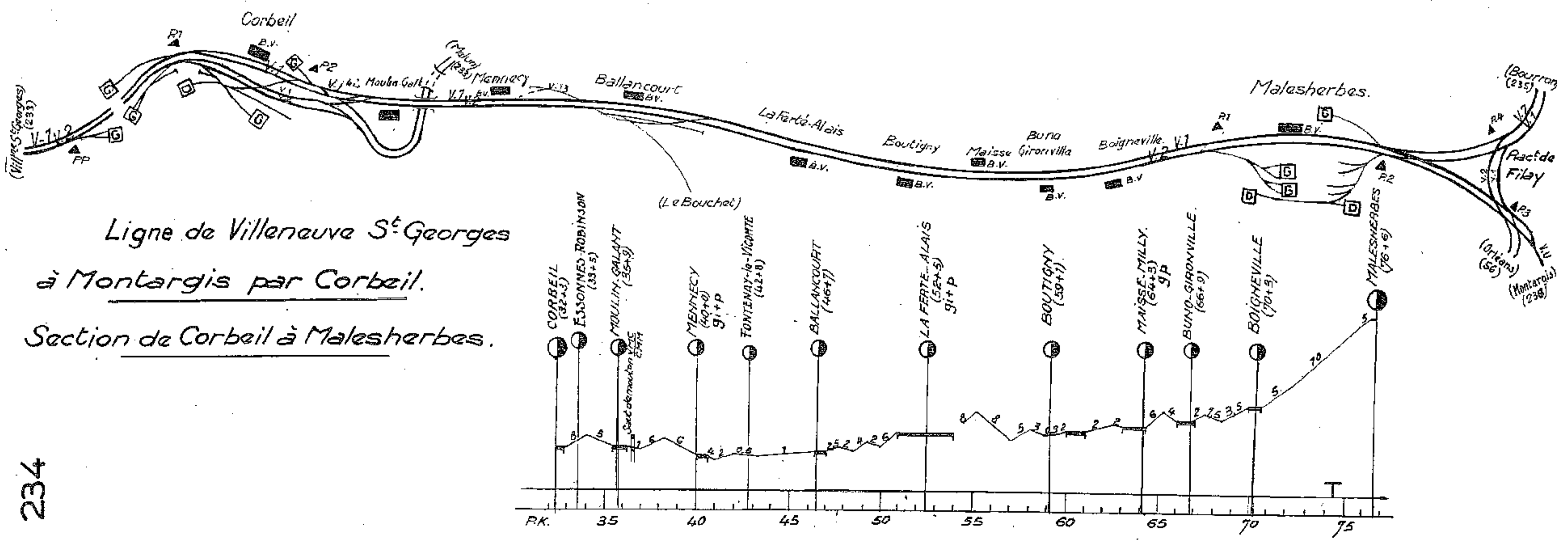

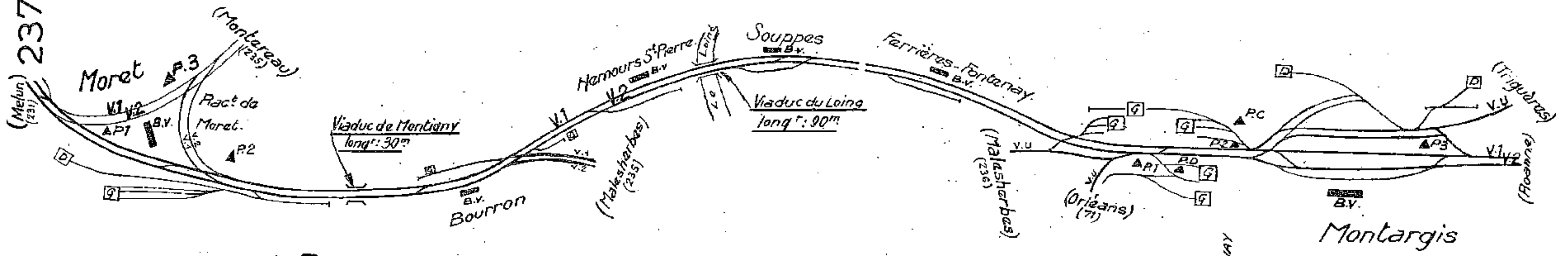

Ligne de Moret à Roanne

Section de Moret à Montargis

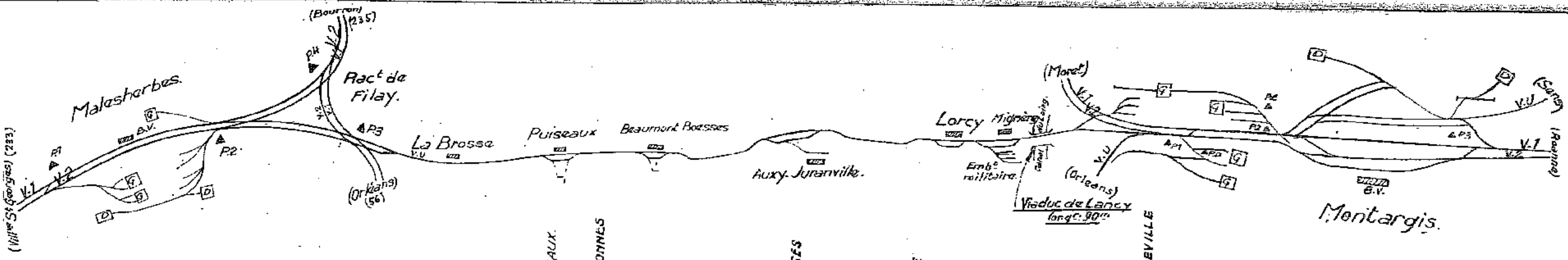
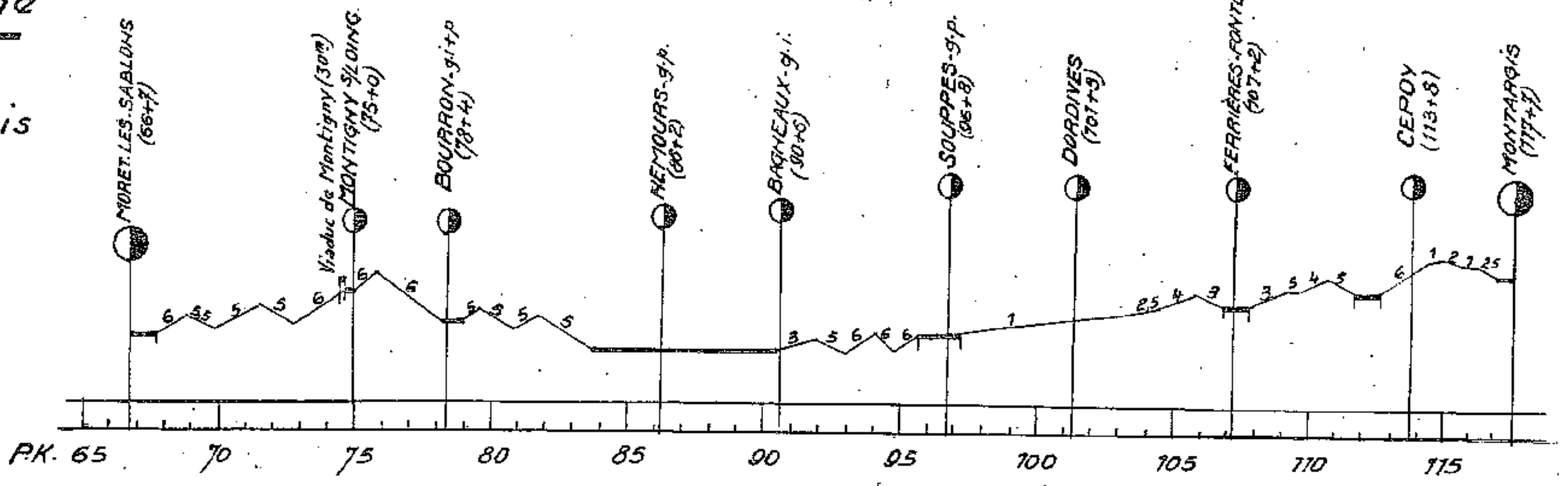

Ligne de Vill^{rs} St-Georges à Montargis par Corbeil.

Section de Malesherbes à Montargis

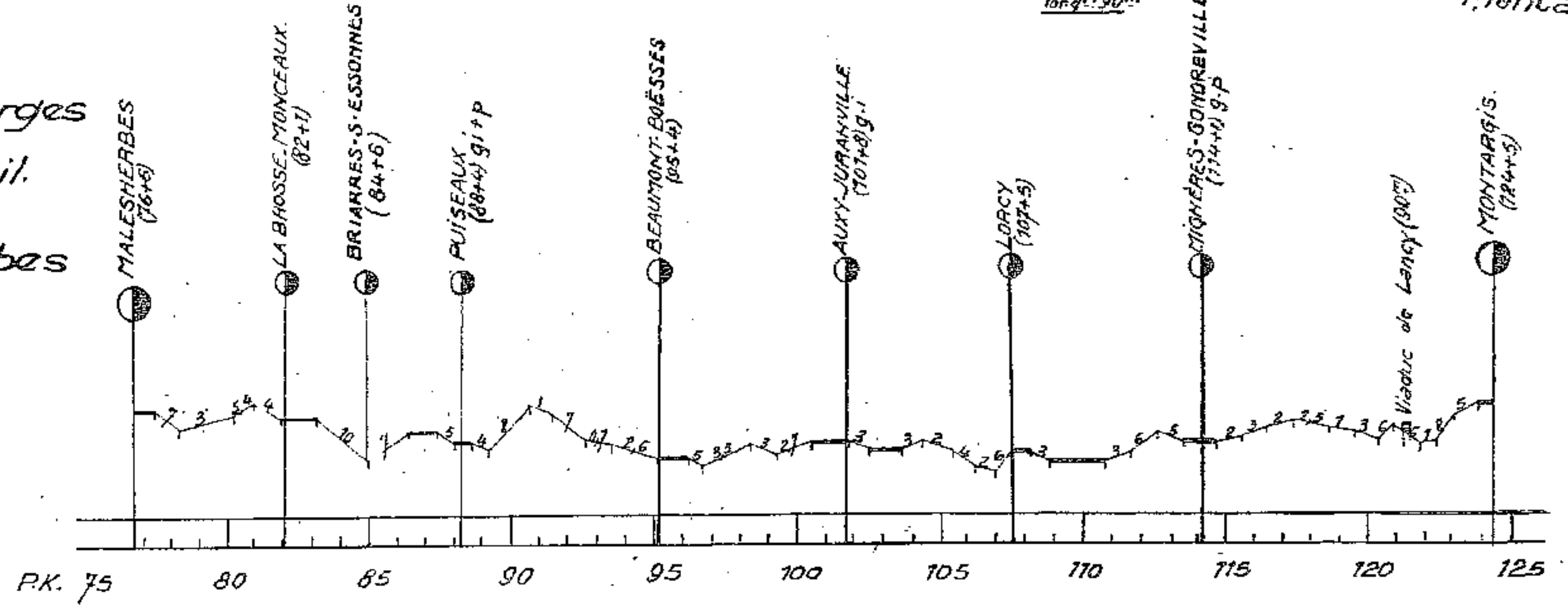

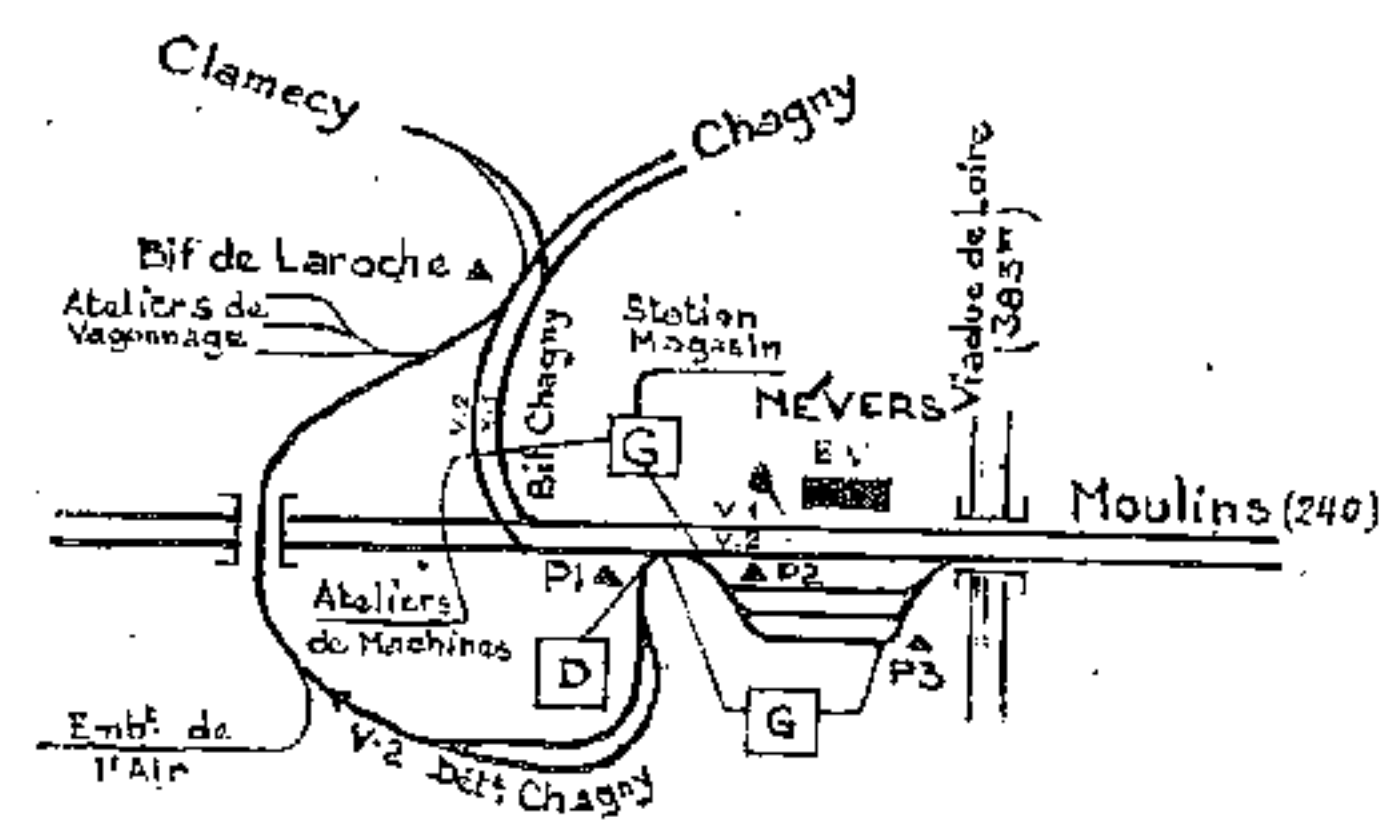
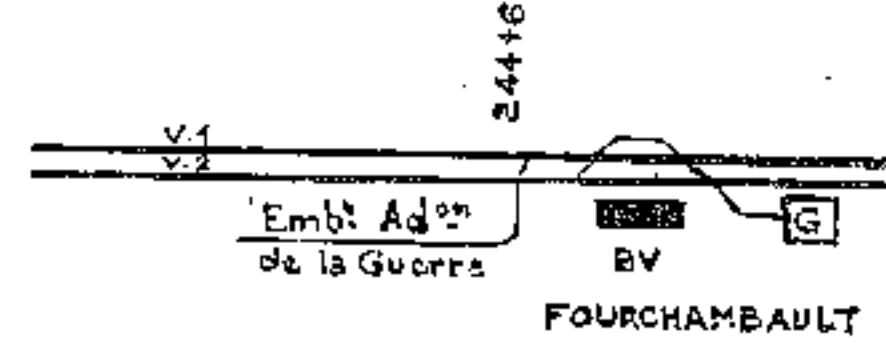
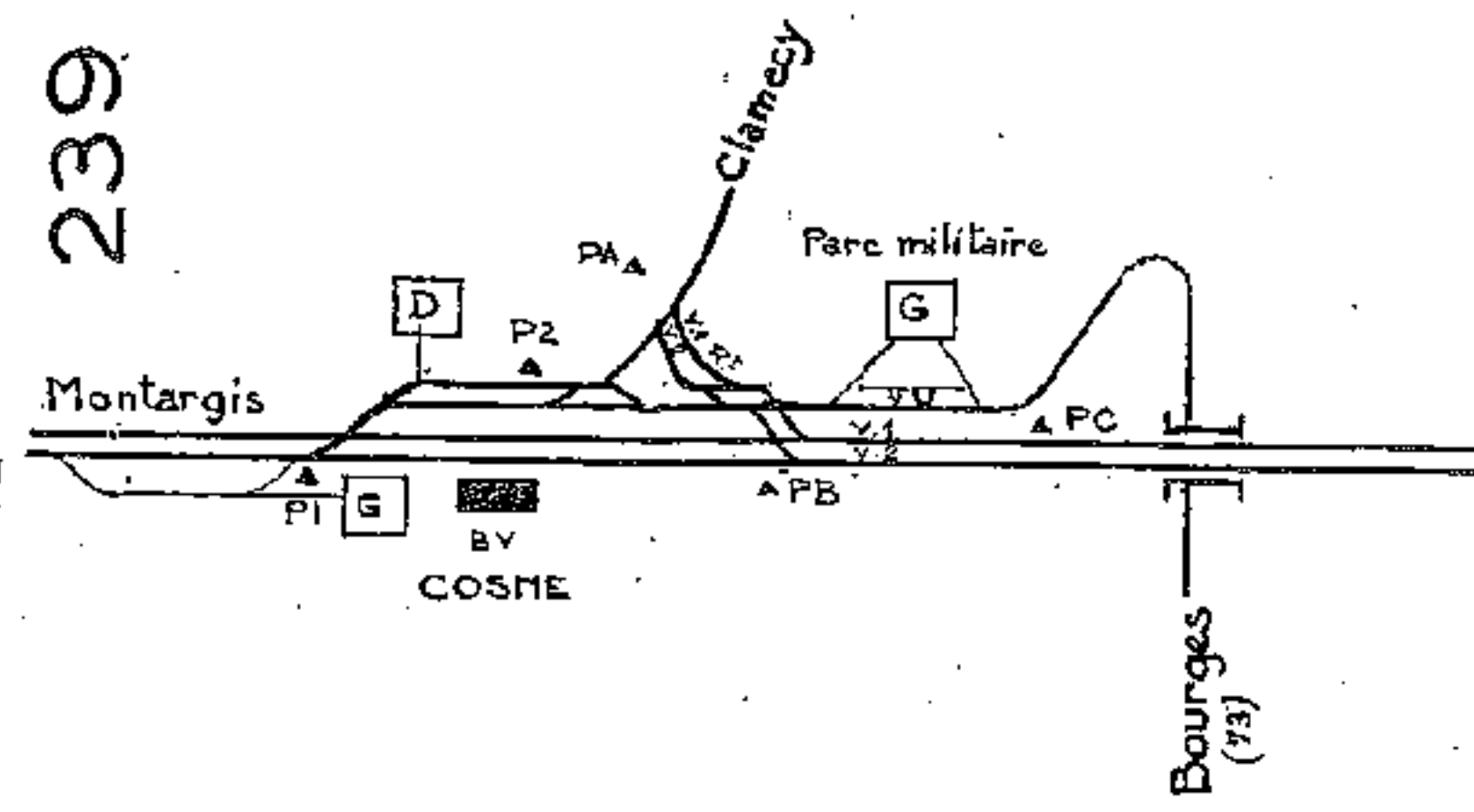

Ligne
de PARIS à CLERMONT-FERRAND
Section de COSNE à NEVERS

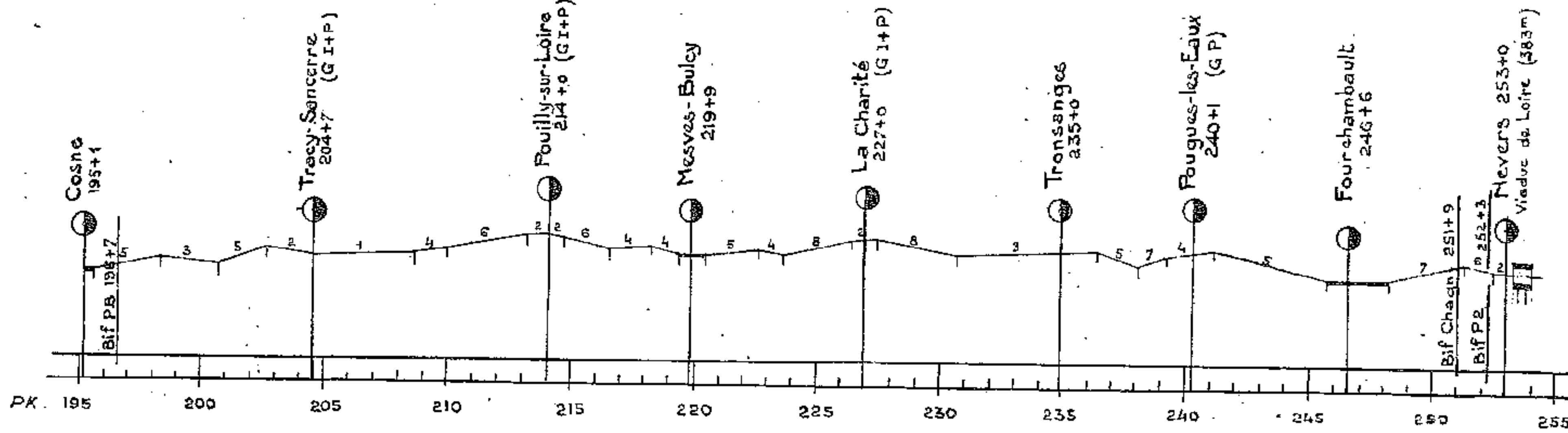

Ligne de Moret à Roanne.
Section de Montargis à Cosne.

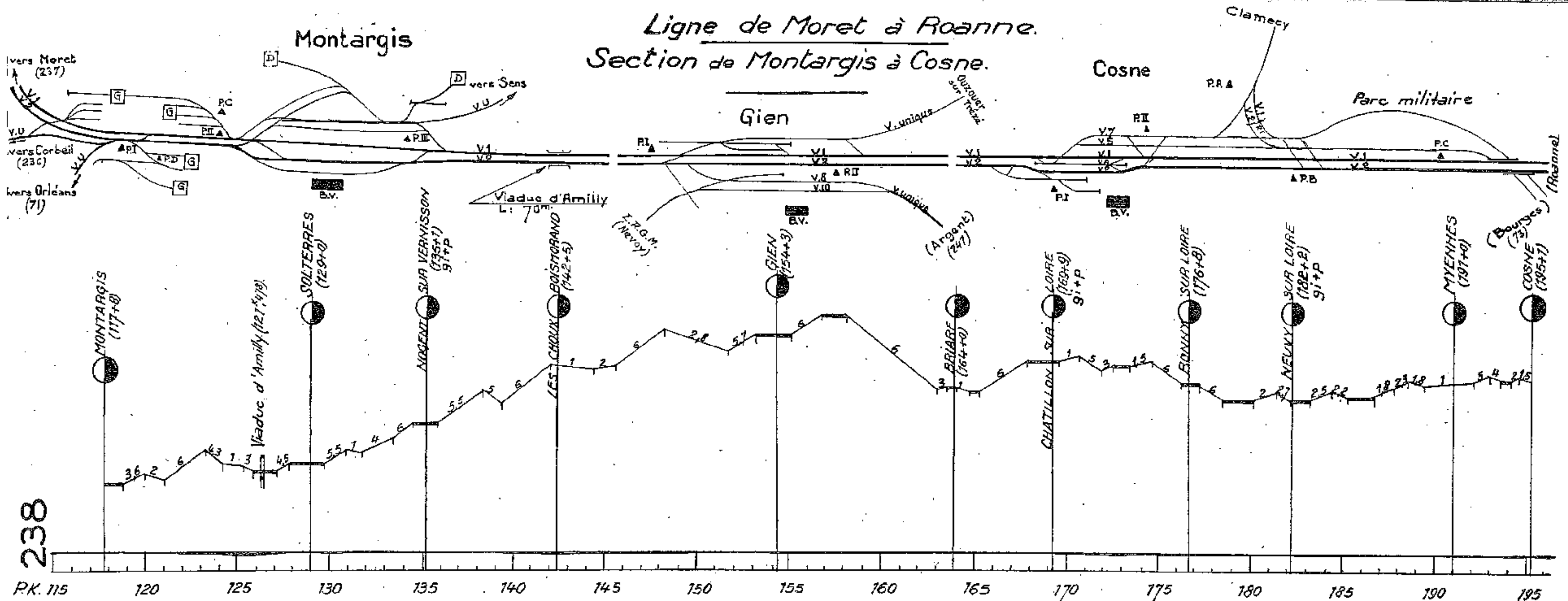

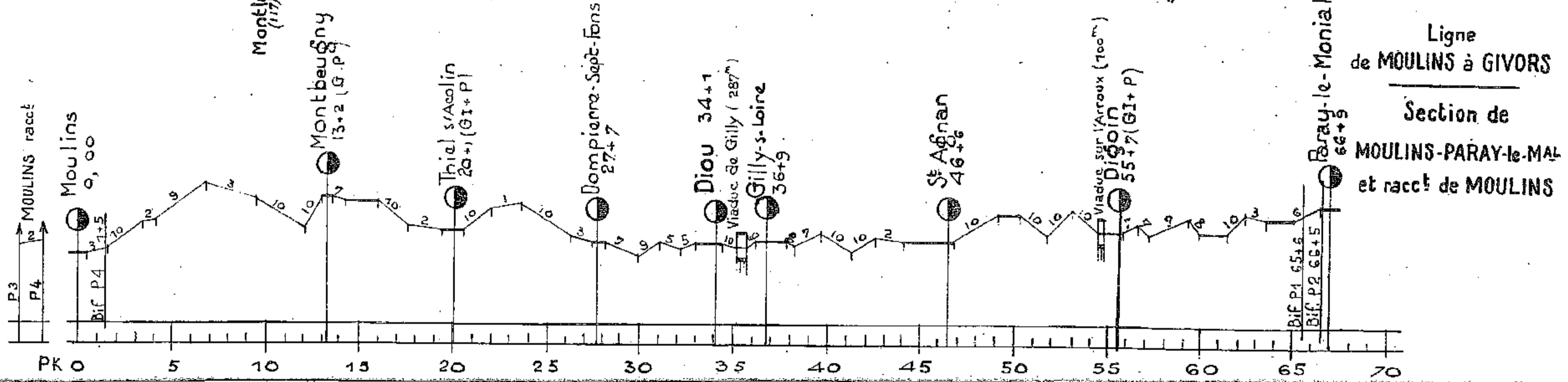
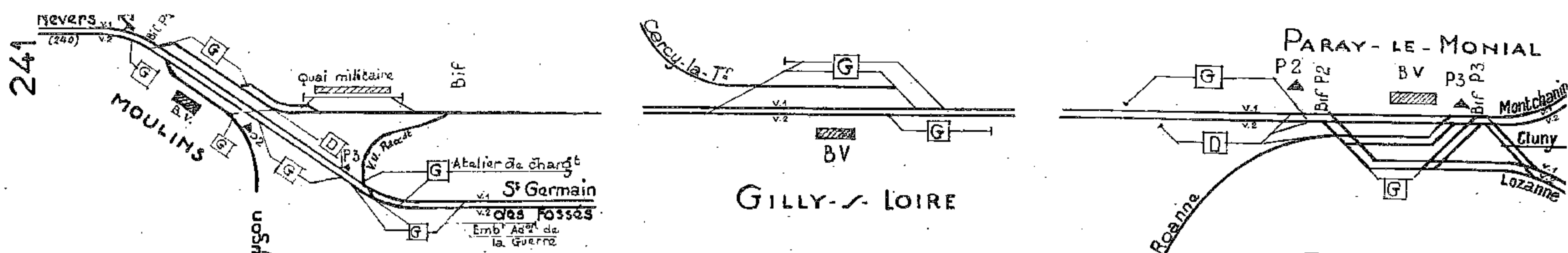

Ligne de MOULINS à GIVORS
Section de MOULINS-PARAY-le-MONIAL et racc! de MOULINS

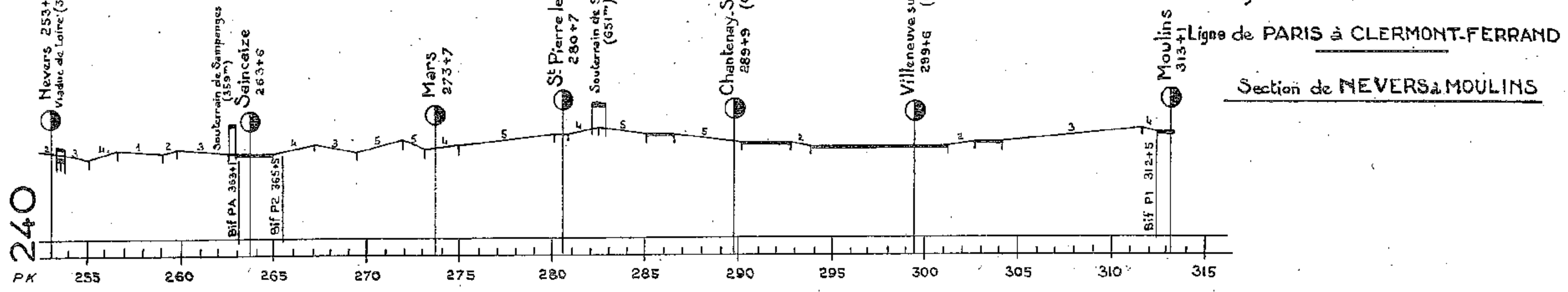
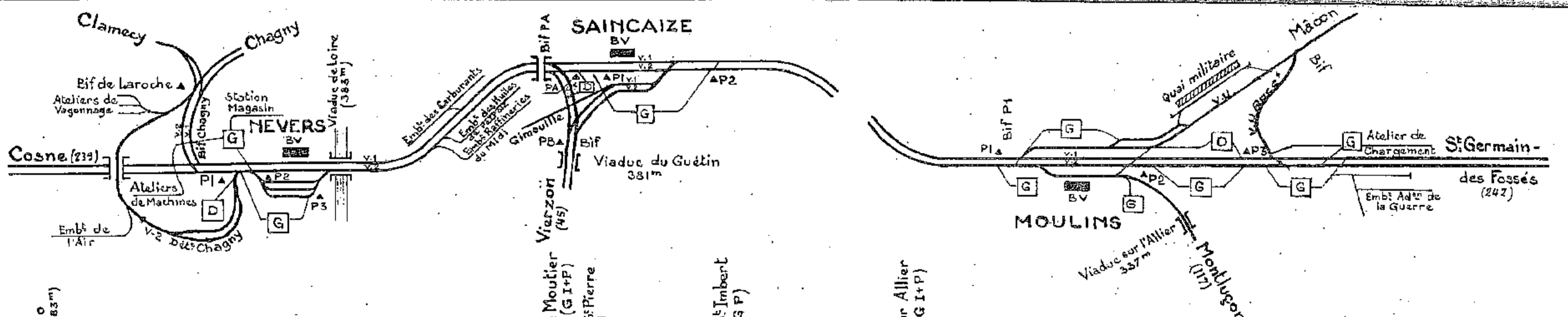

Ligne de PARIS à CLERMONT-FERRAND
Section de NEVERNS à MOULINS

Ligne de S^t GERMAIN à NIMES
Section de S^t GERMAIN à RIOM par GANNAT

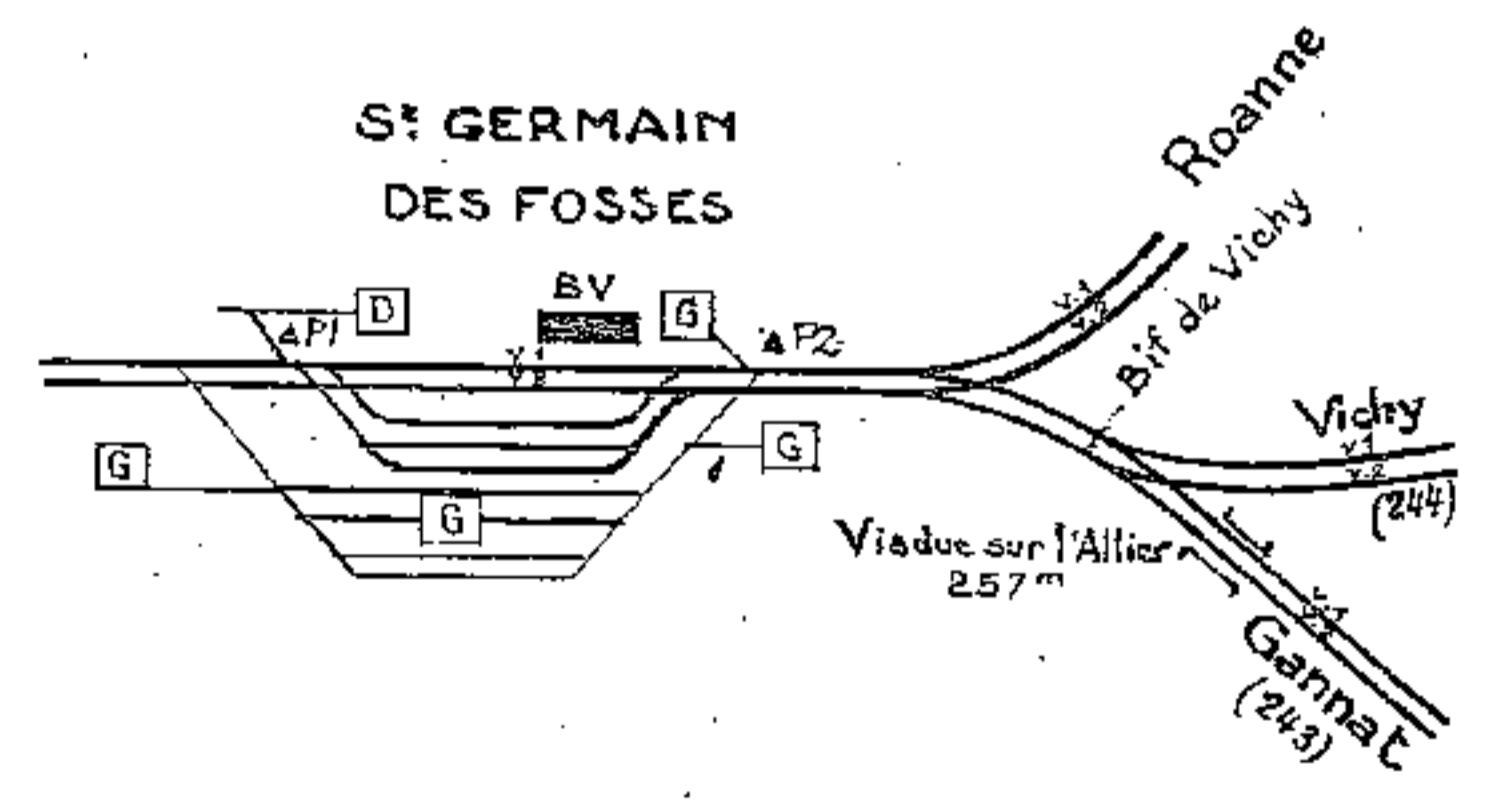
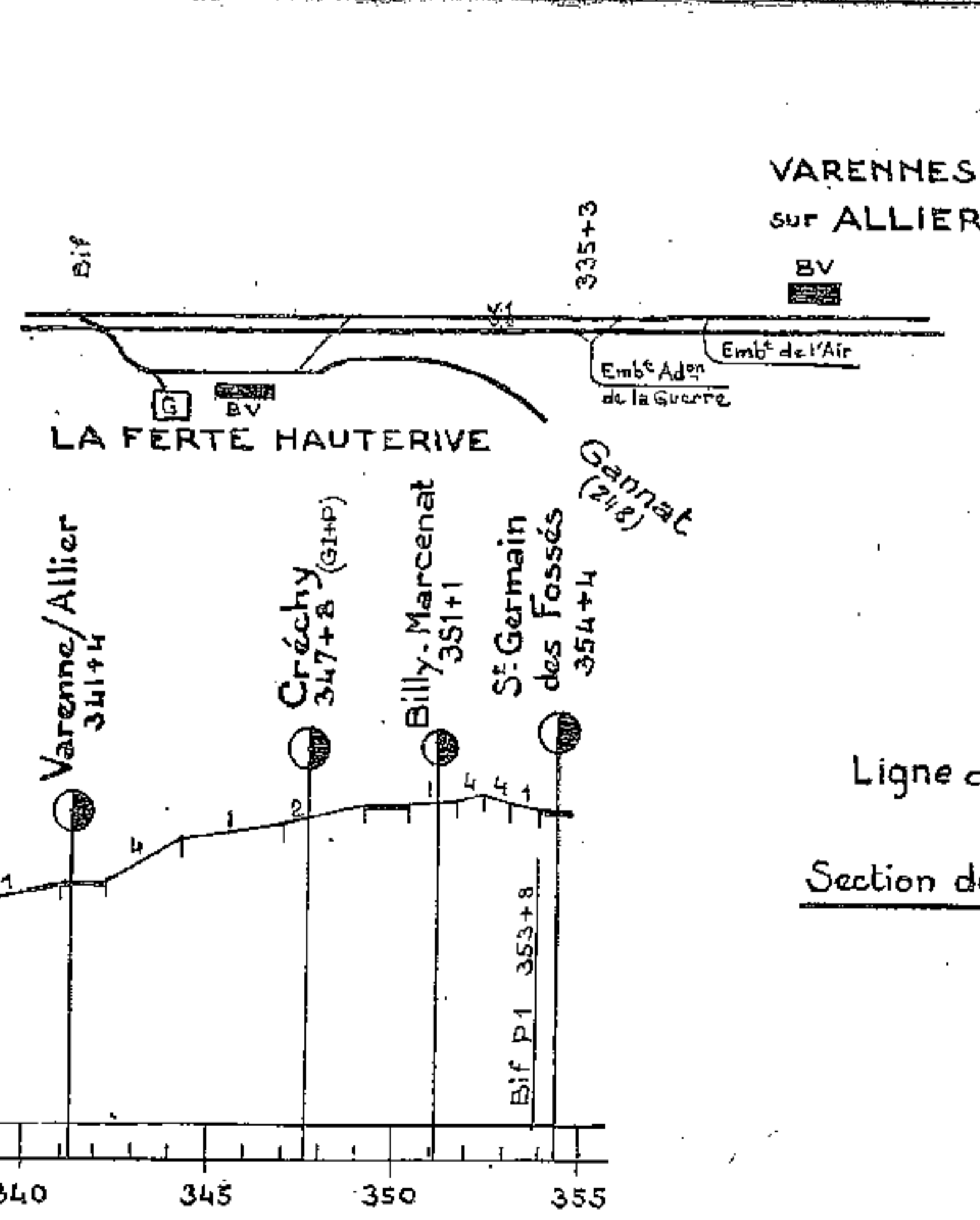
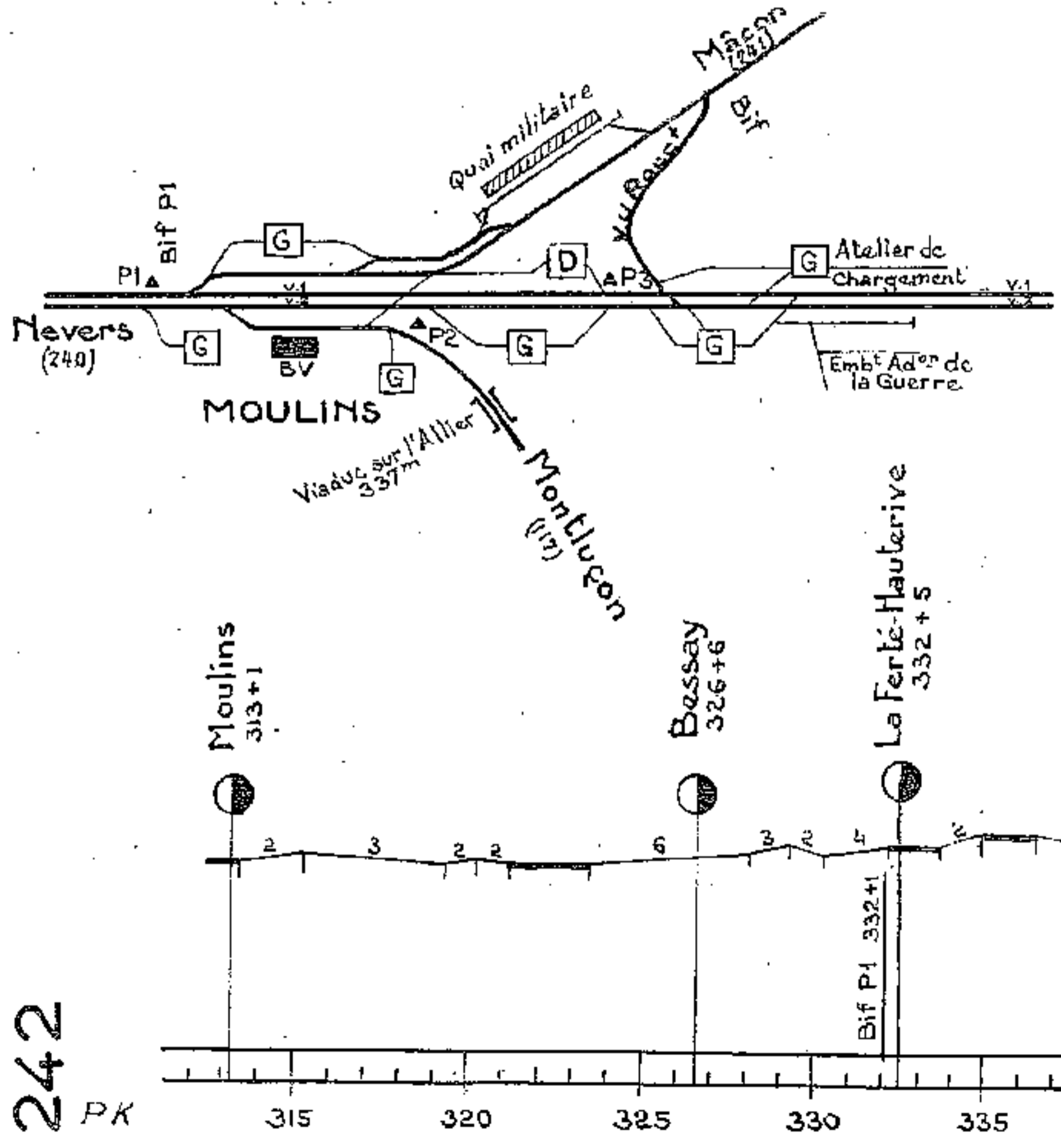
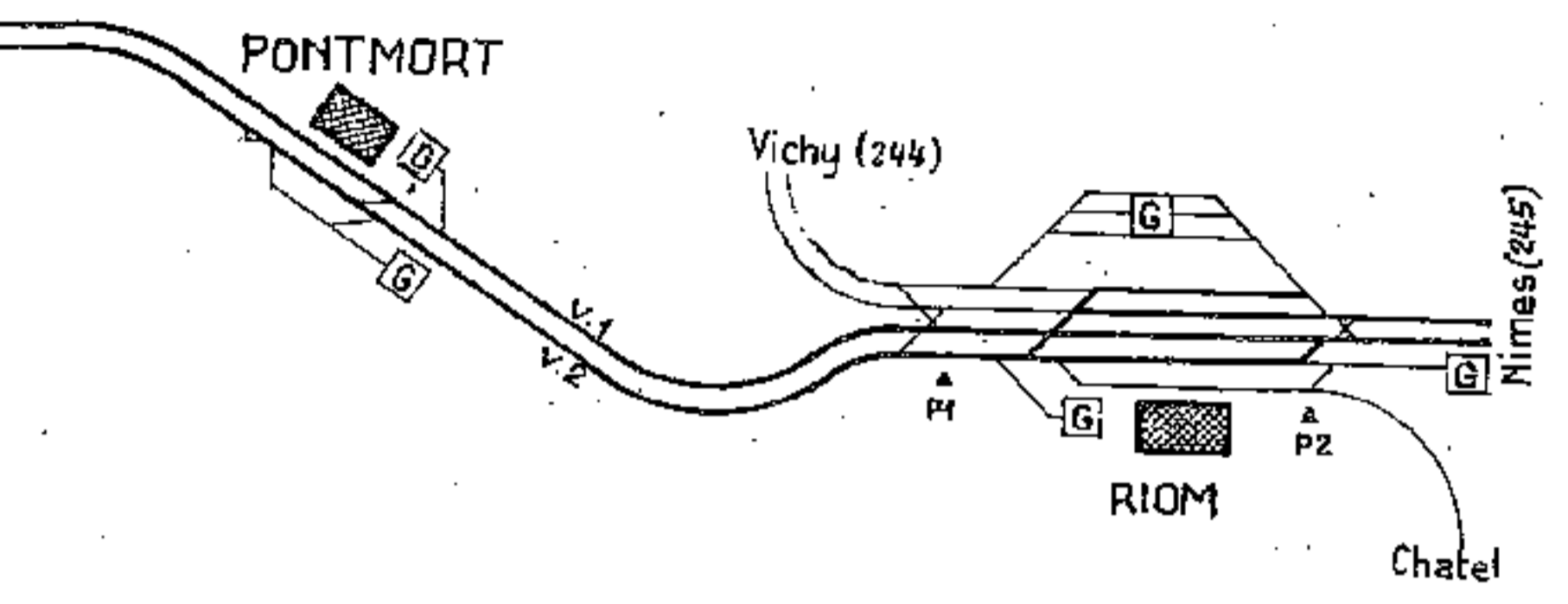
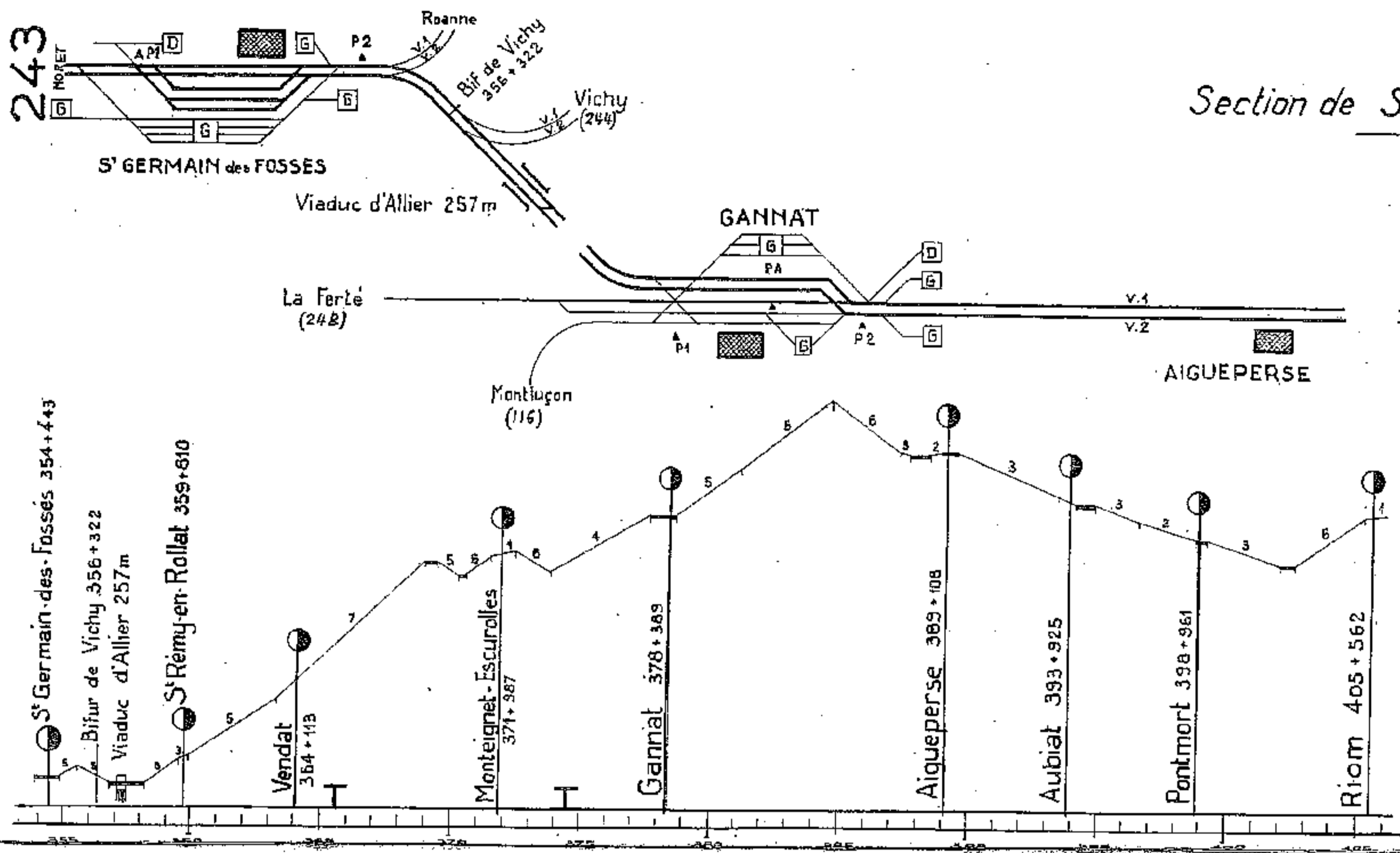

Ligne de PARIS à CLERMONT-FERRAND
Section de MOULINS à S^t GERMAIN des FOSSES

PK

315 320 325 330 335 340 345 350 355

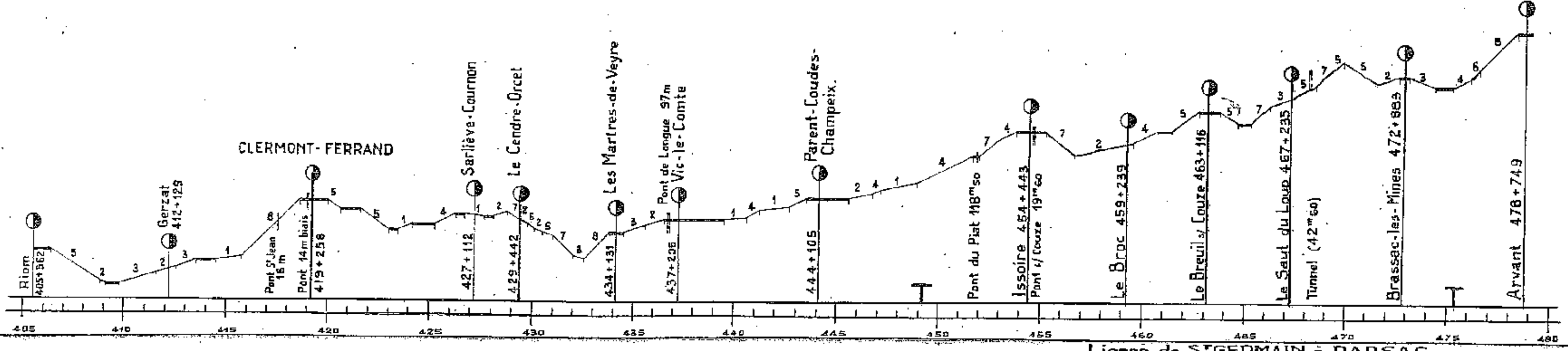
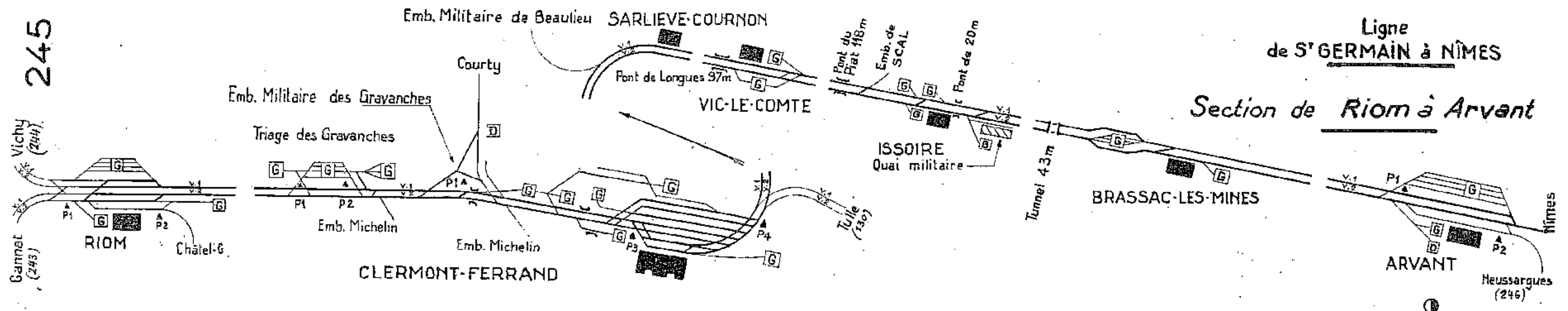

Lignes de S^t GERMAIN à DARSAC

et de VICHY à RIOM
Section de S^t GERMAIN à RIOM

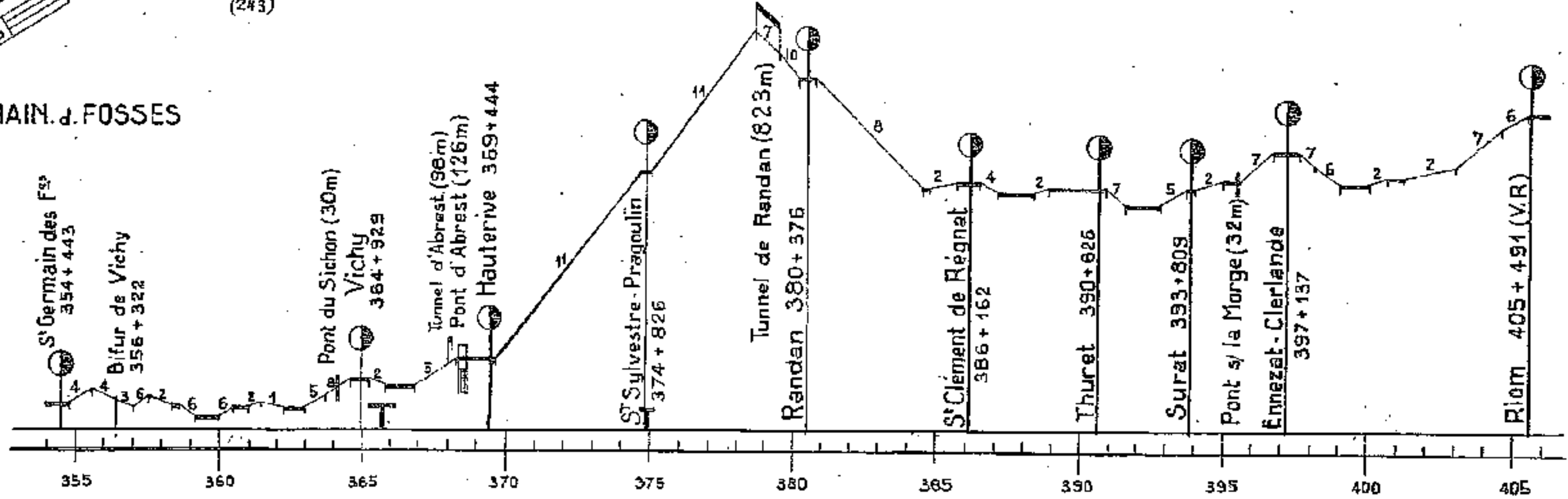
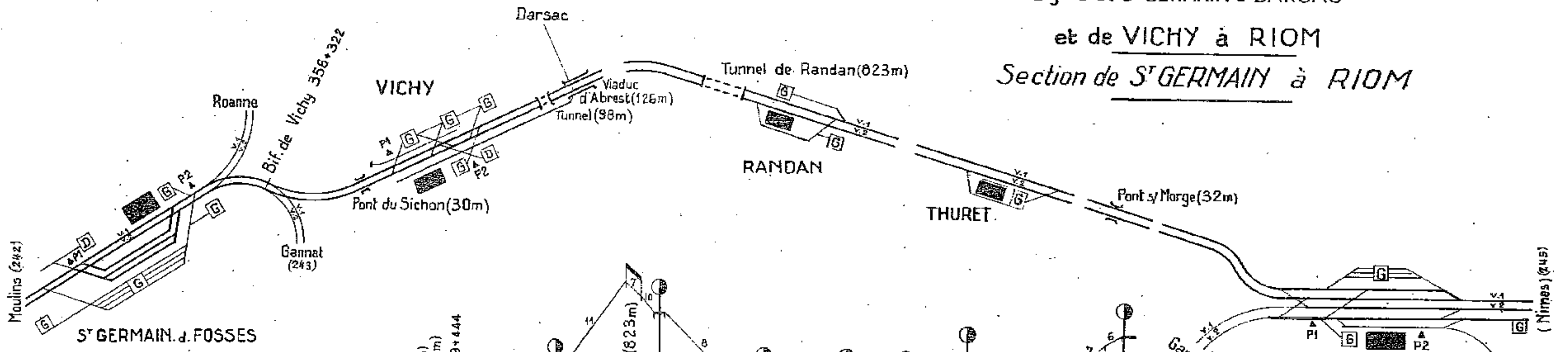

Ligne de Gien à Argent

Section de Gien à Argent

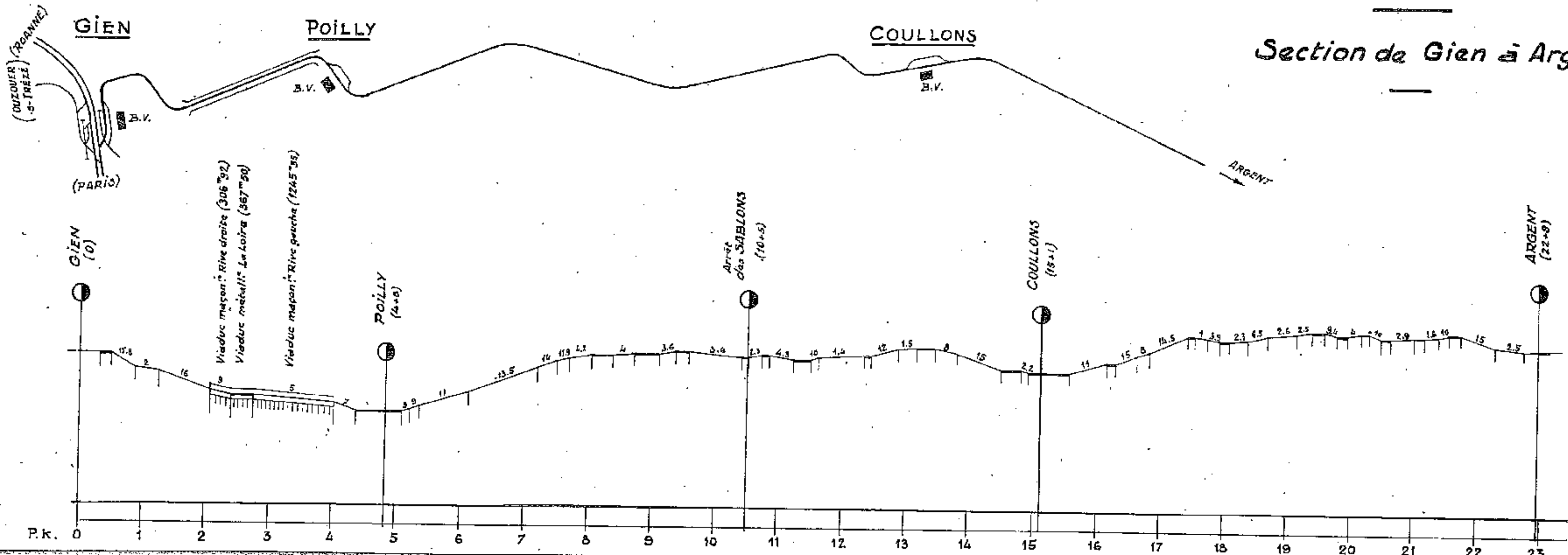

Abords d'Arvant

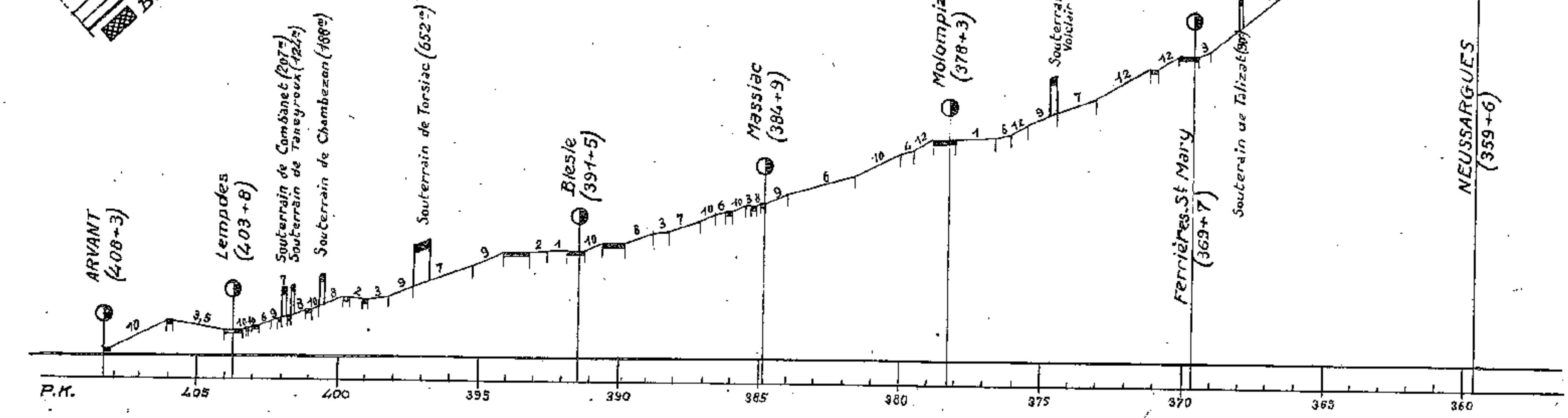
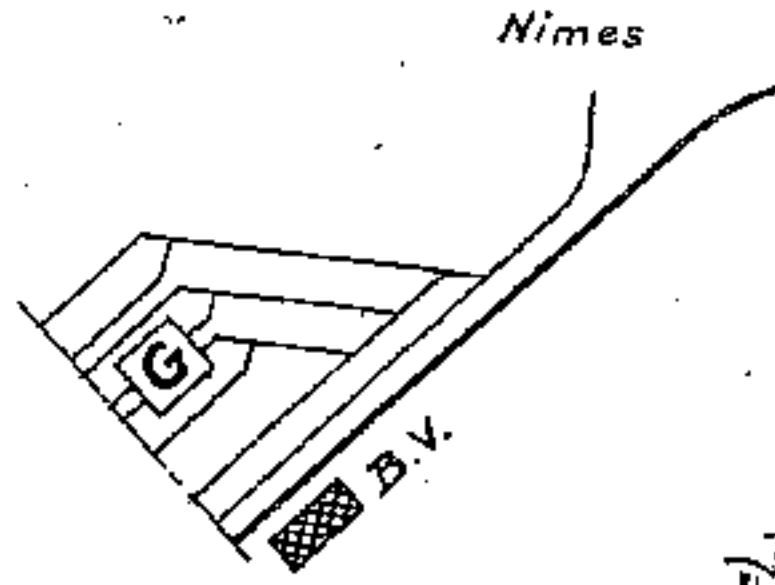

Ligne de BORDEAUX à SÈTE

Section de LEZIGNAN à SÈTE

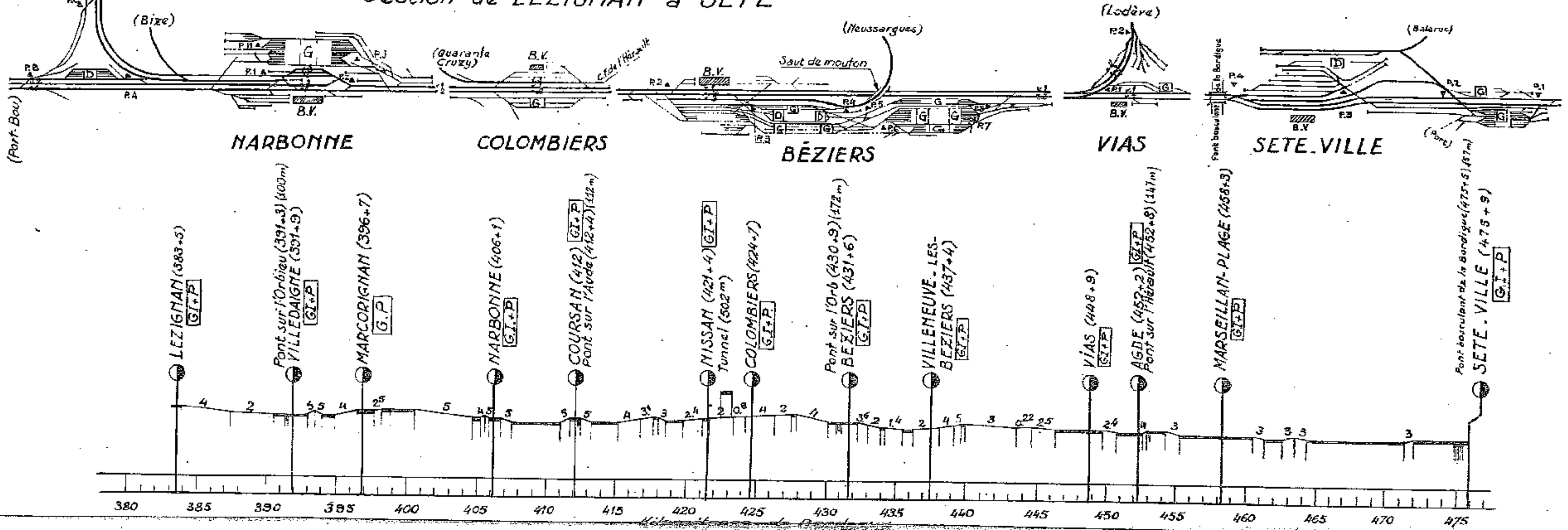

Ligne de LA FERTE-GANNAT

Section de LA FERTE à GANNAT

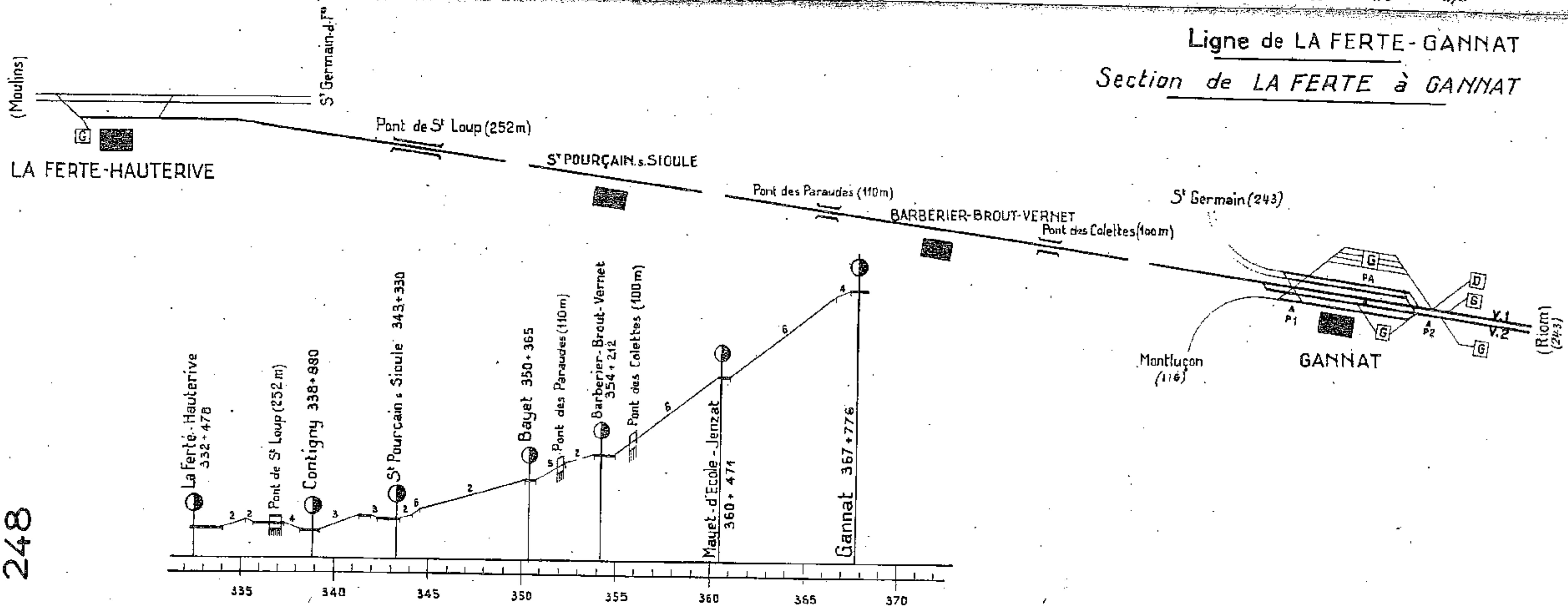

Ligne de CASTRES à BÉDARIEUX

Section de S^t PONS à BÉDARIEUX
(S^t Pons)

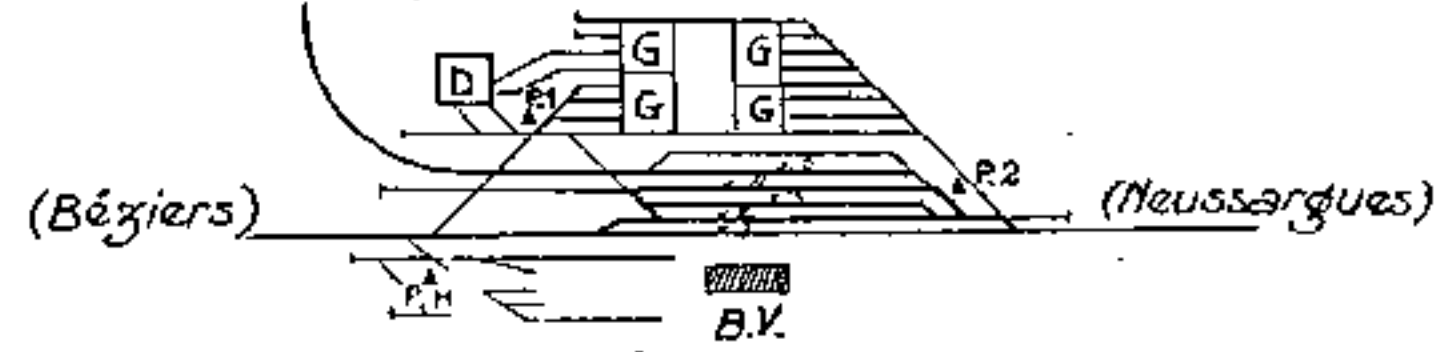

BÉDARIEUX

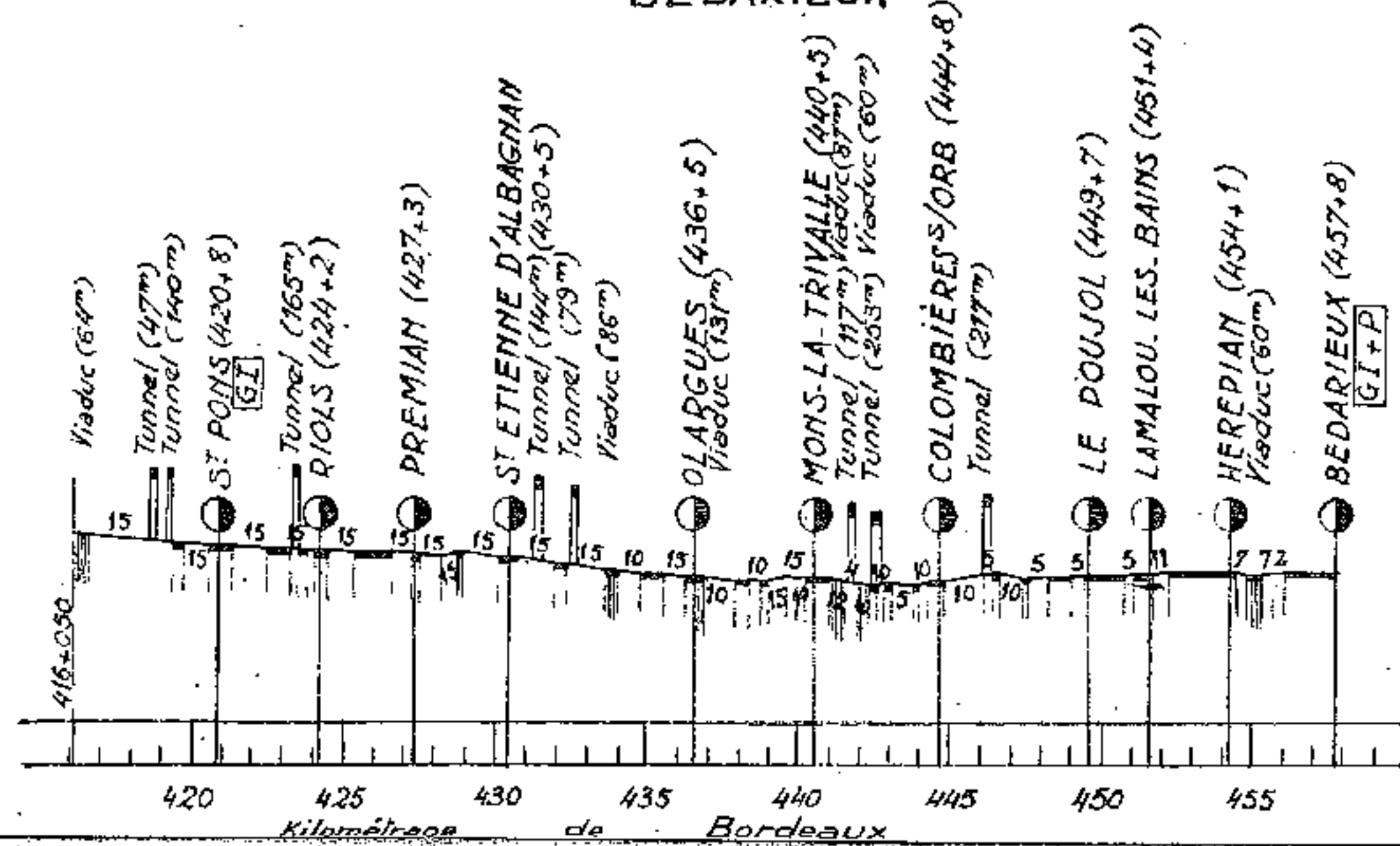

Ligne de TOURNEMIRE-

ROQUEFORT à S^t AFFRIQUE

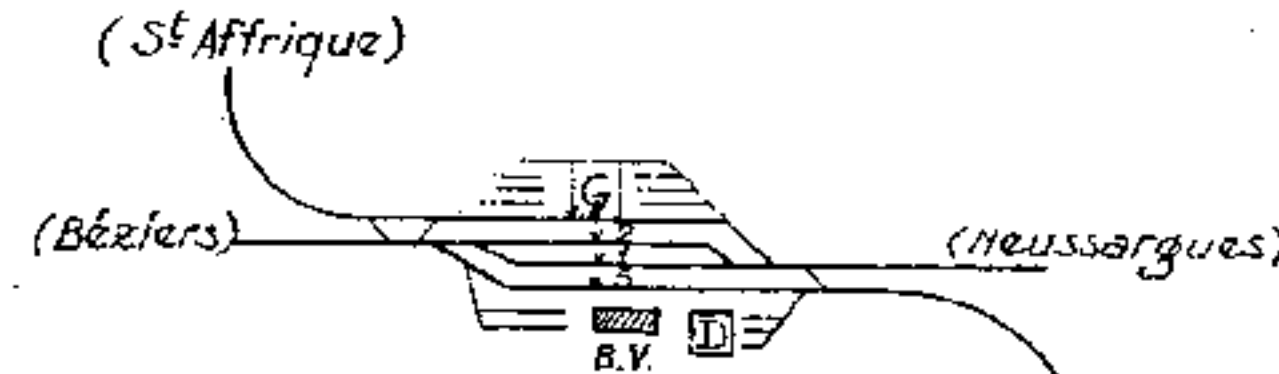

TOURNEMIRE-ROQUEFORT
(Le Vigan)

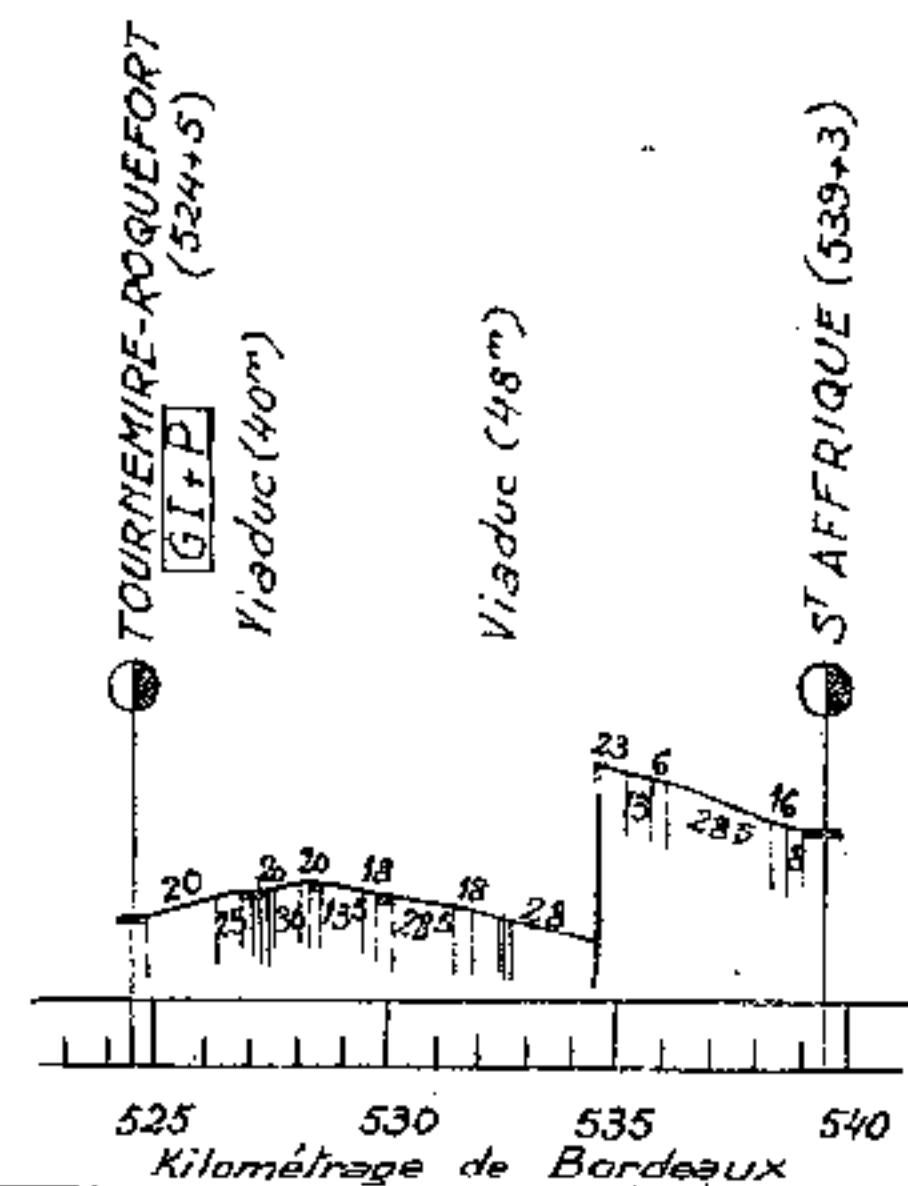

Ligne de LATOUR

à PLAISANCE

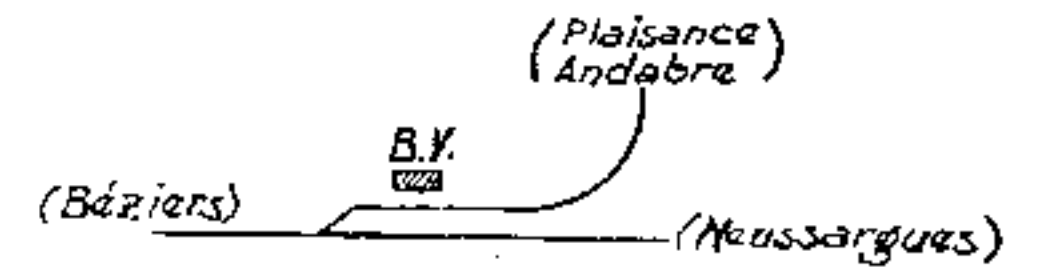

POSTE de LATOUR

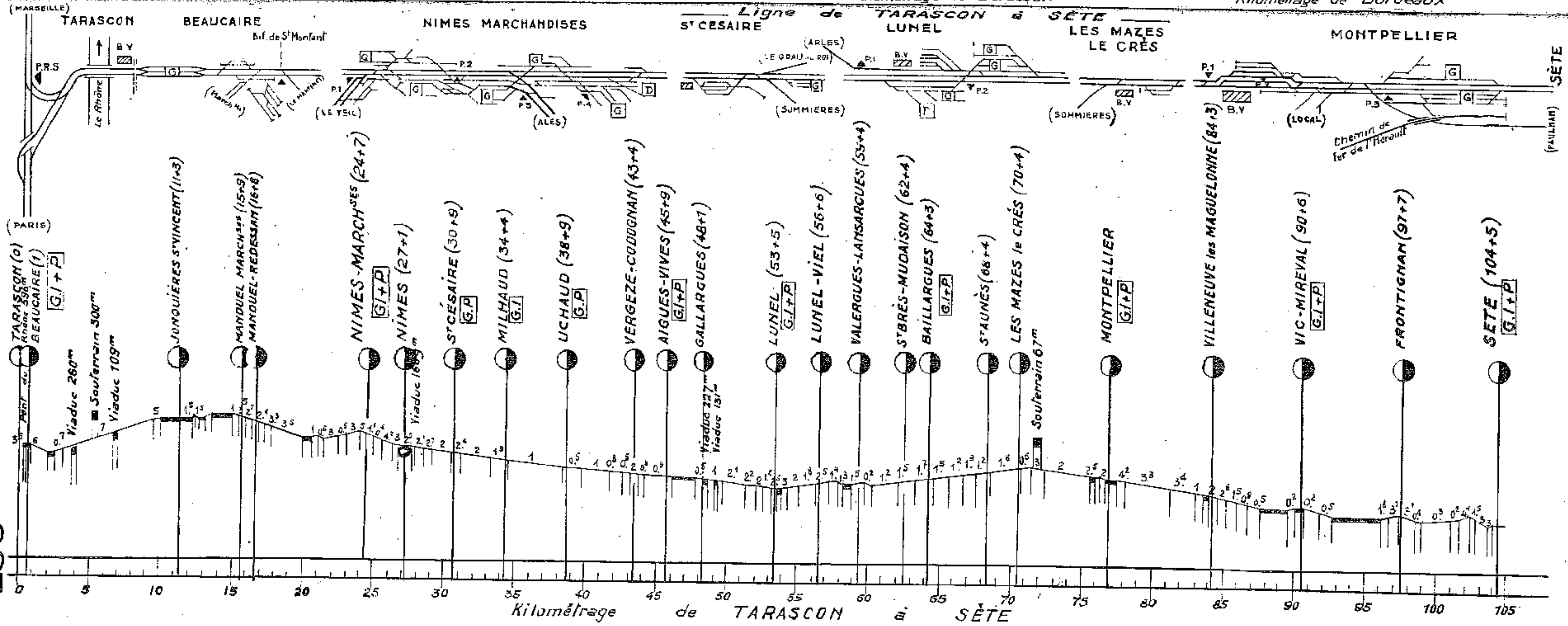
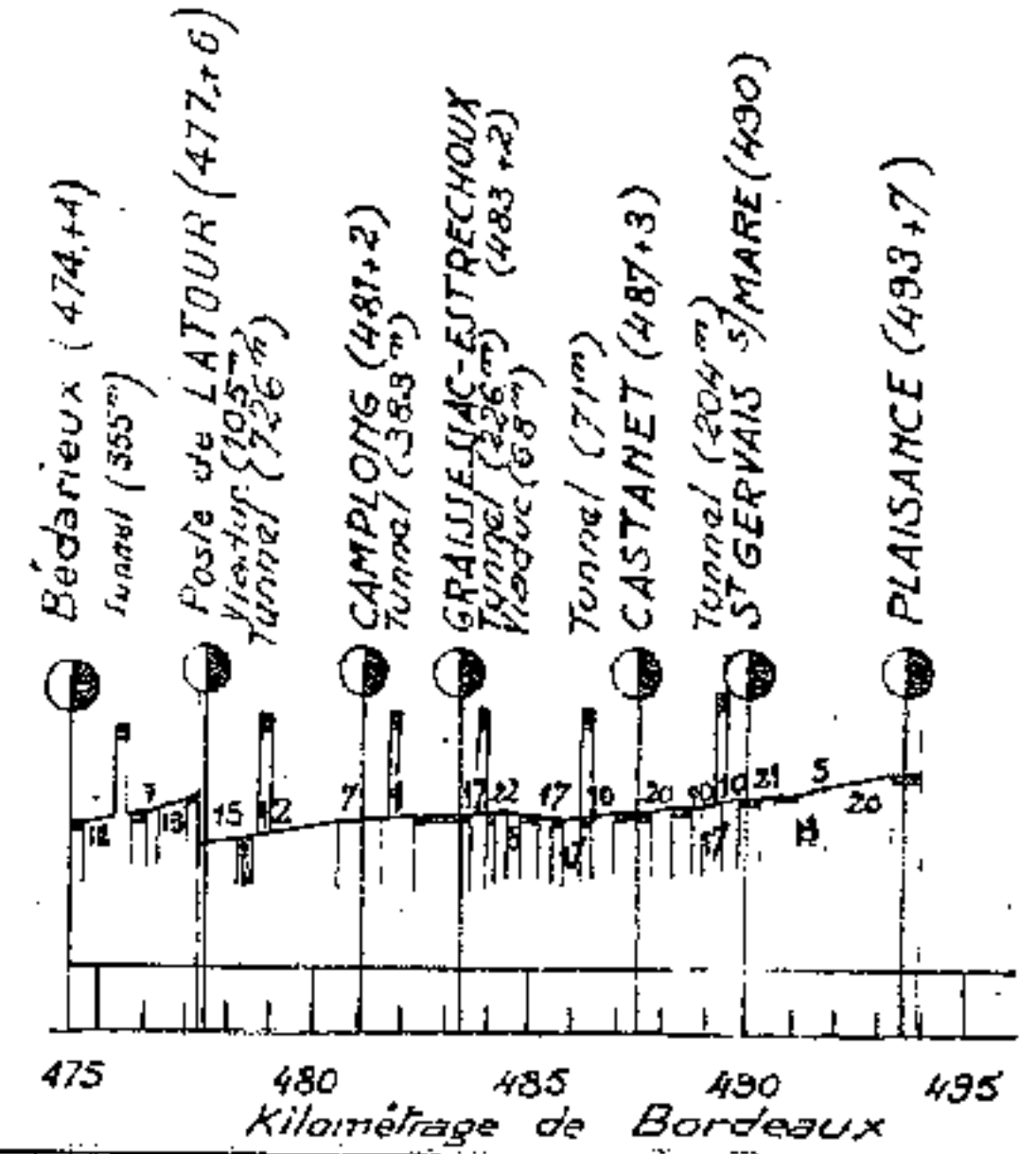

Ligne de LE MONASTIER à LA BASTIDE-S^t LAURENT les BAINS

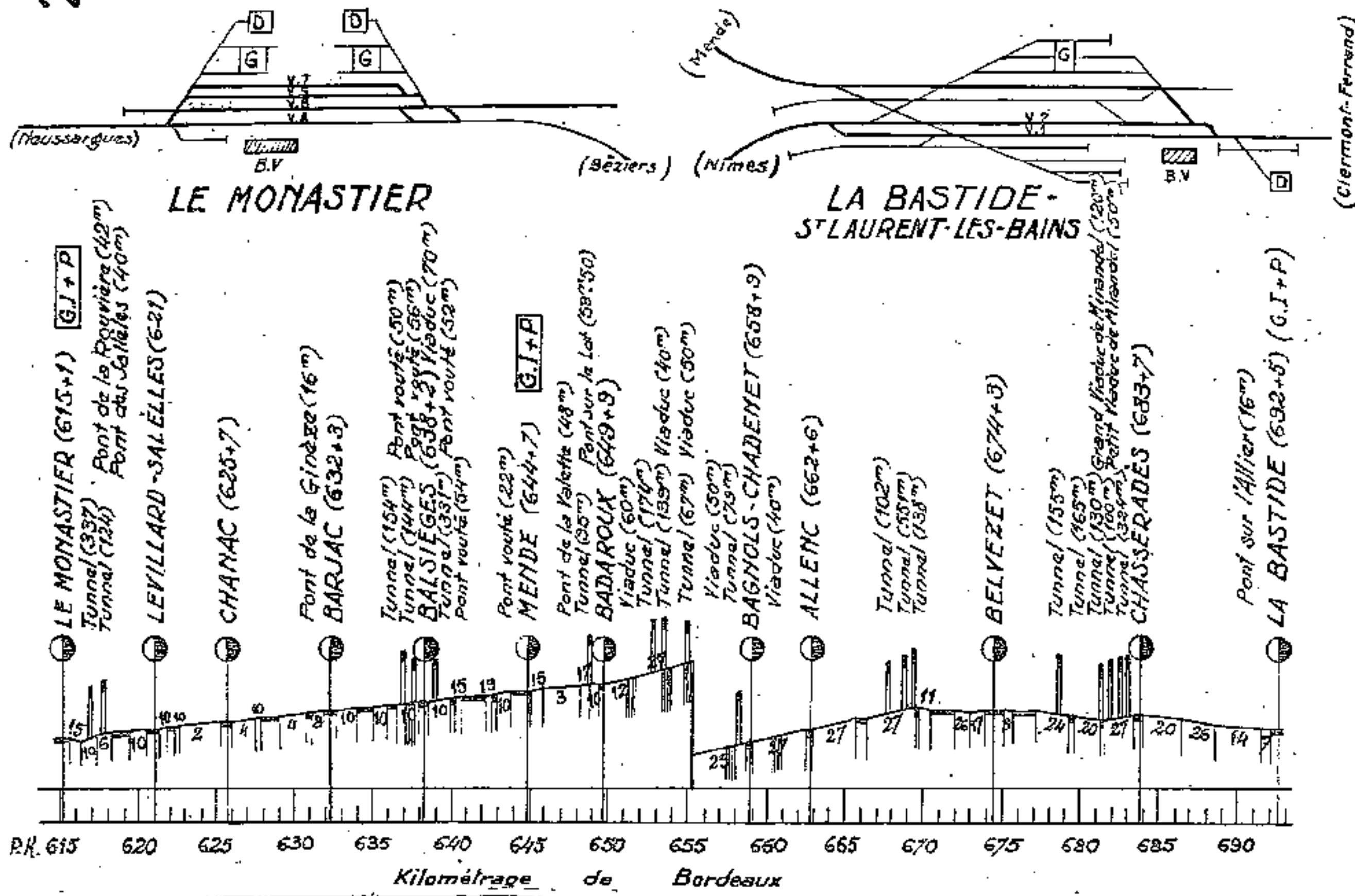

Ligne de SÉVERAC-le-CHATEAU à RODEZ

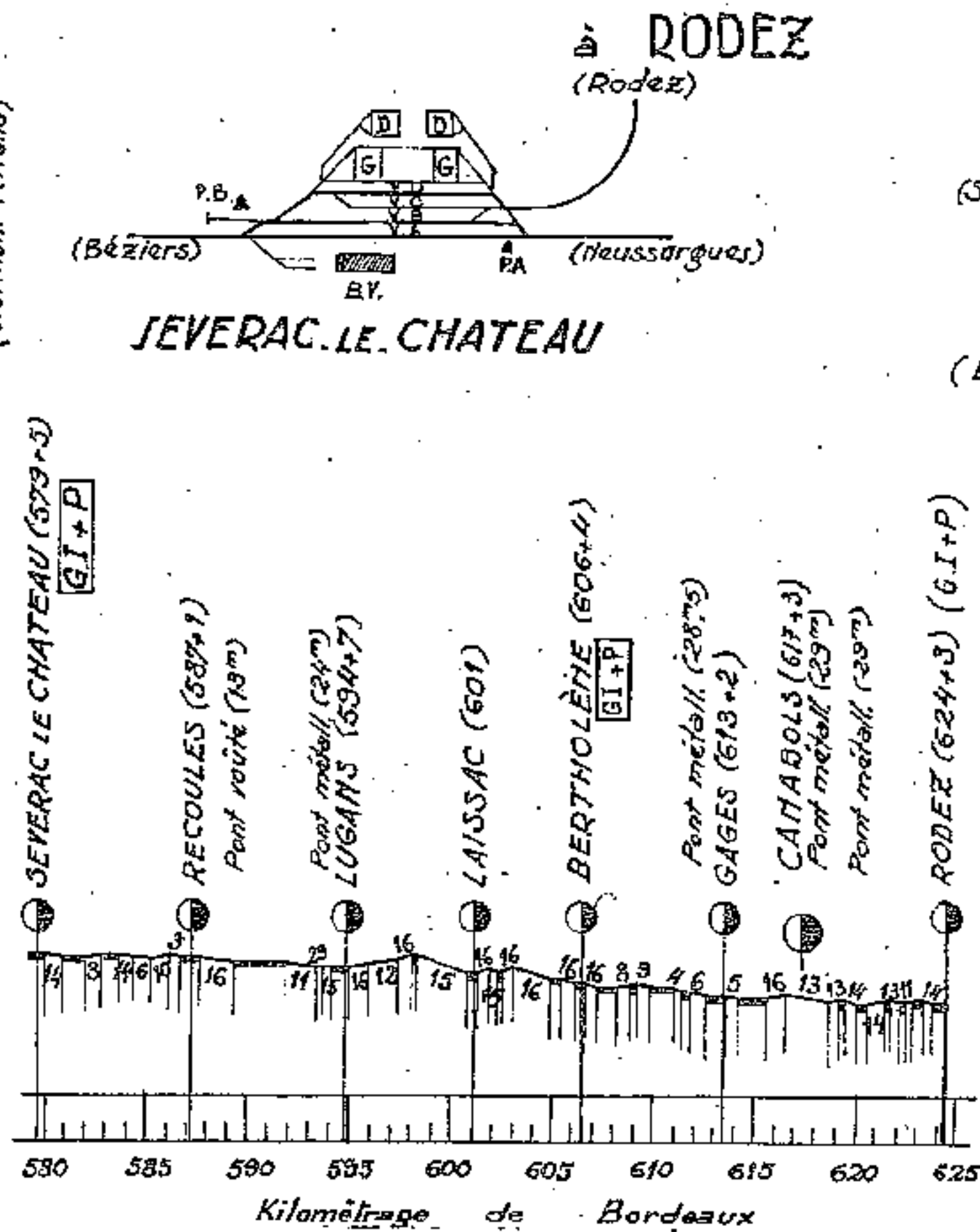

Ligne de BERTHOLÈNE à ESPALION

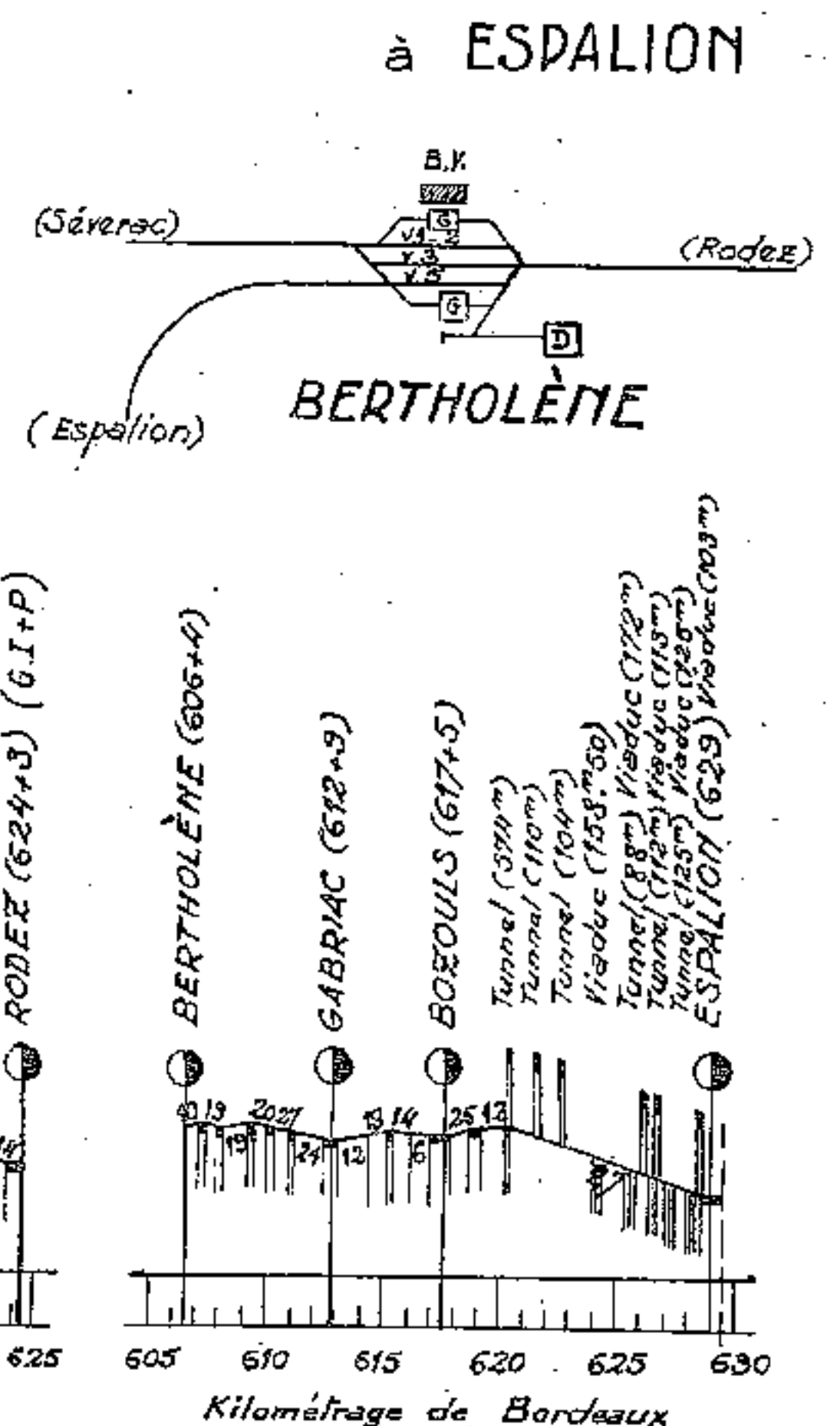

Ligne de FAUGÈRES à PAULHAN et de PAULHAN à MONTPELLIER

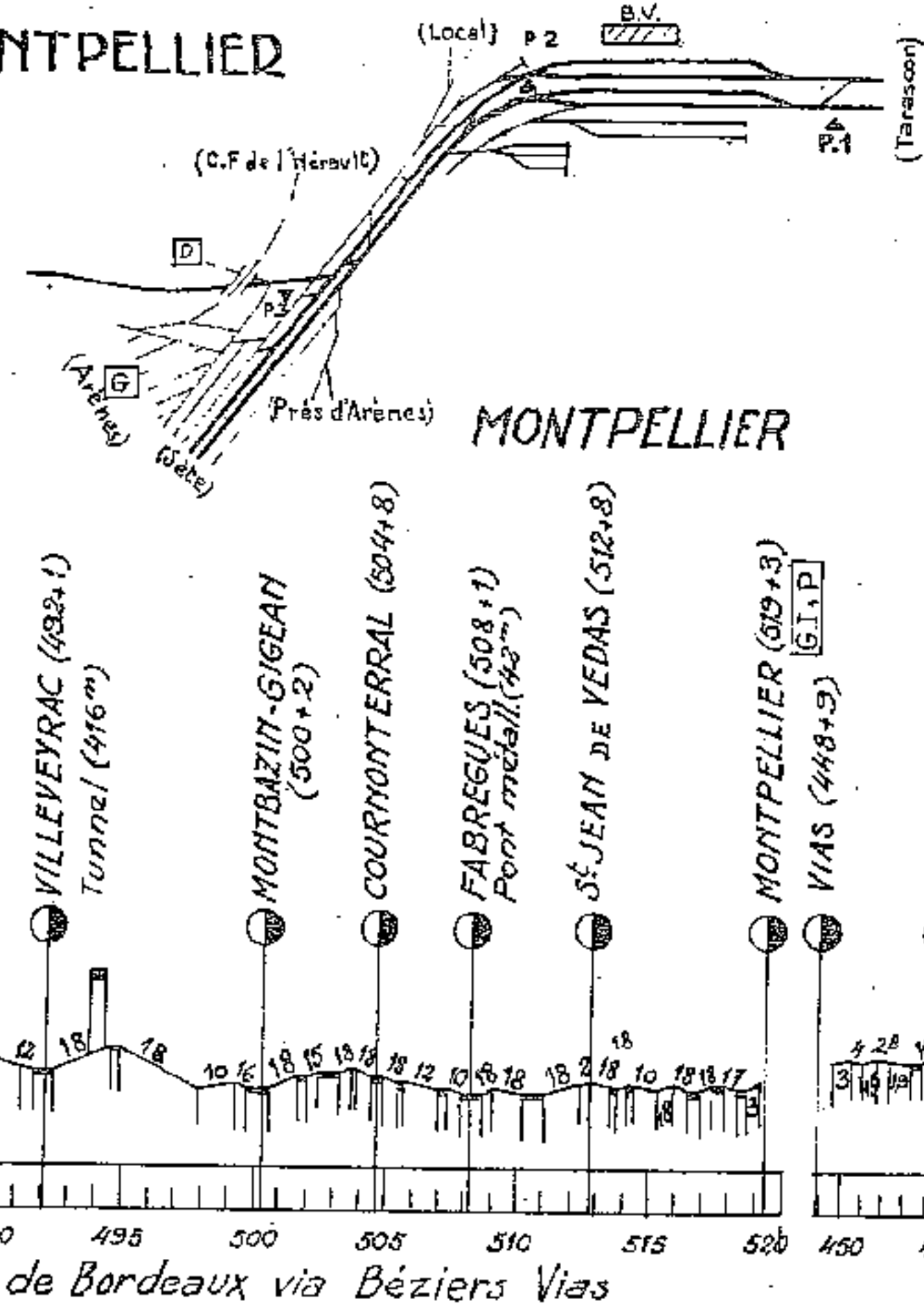
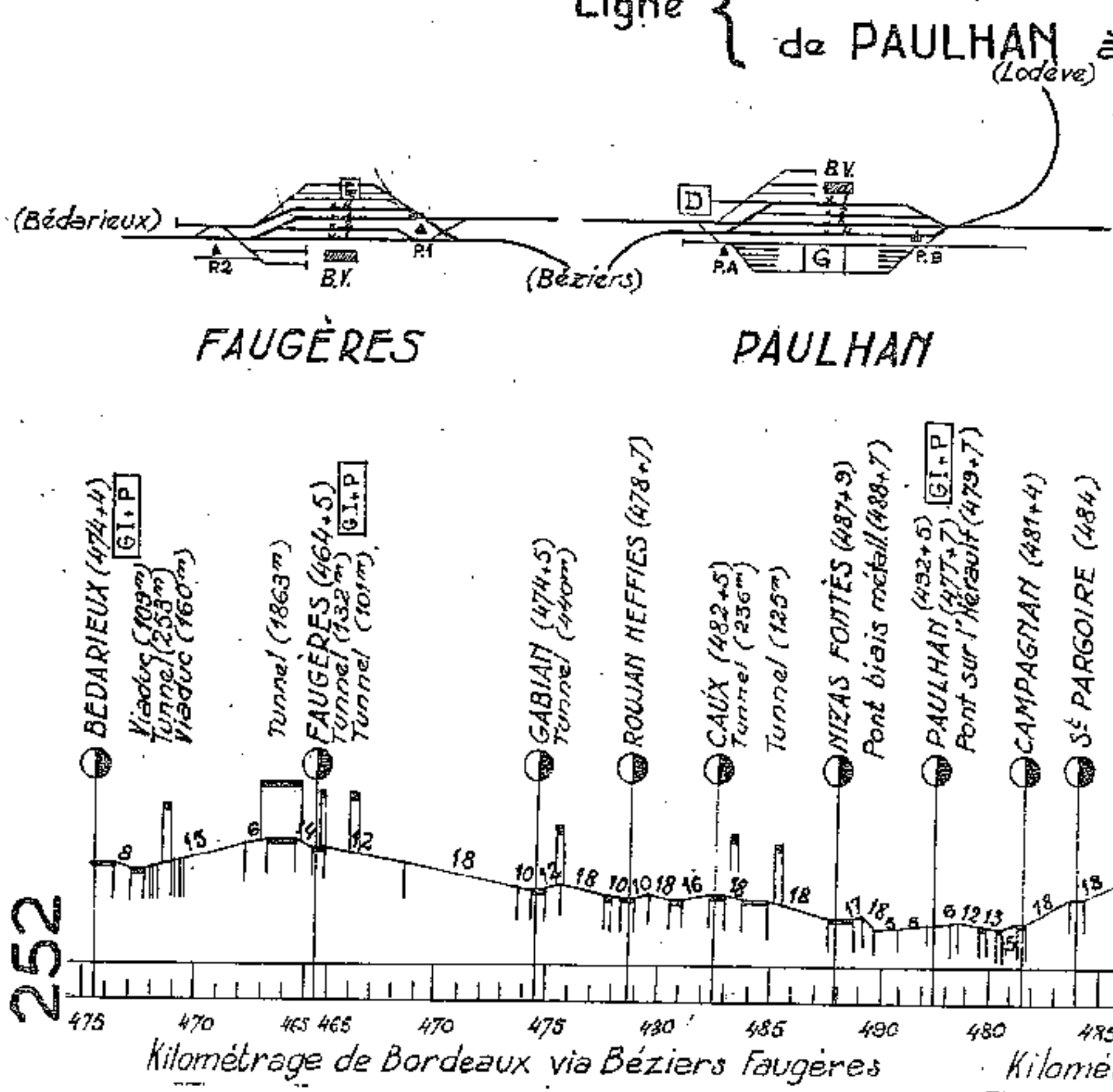

Ligne de VIAS à LODÈVE

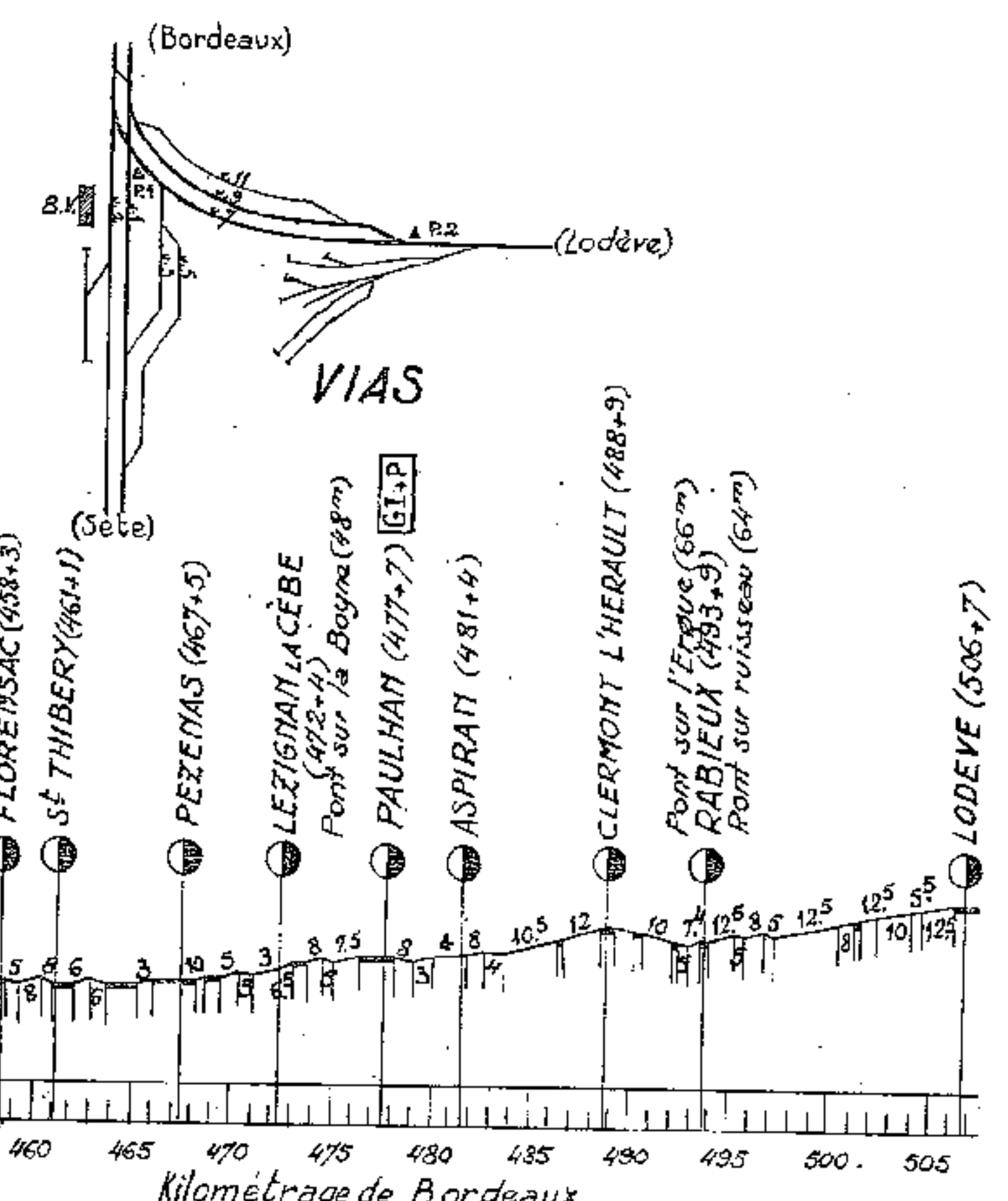

Ligne de FLAMBOIN à MONTEREAU

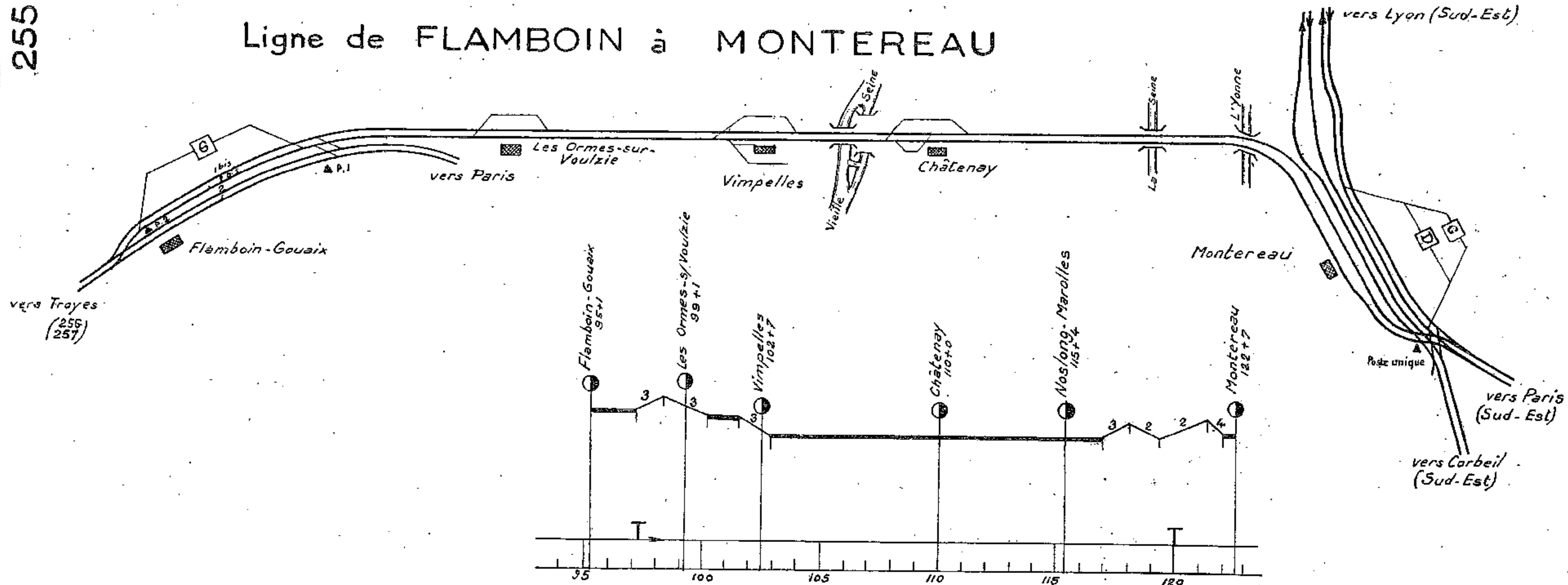

Ligne de PARIS à STRASBOURG (KEHL) Section de Paris à Meaux

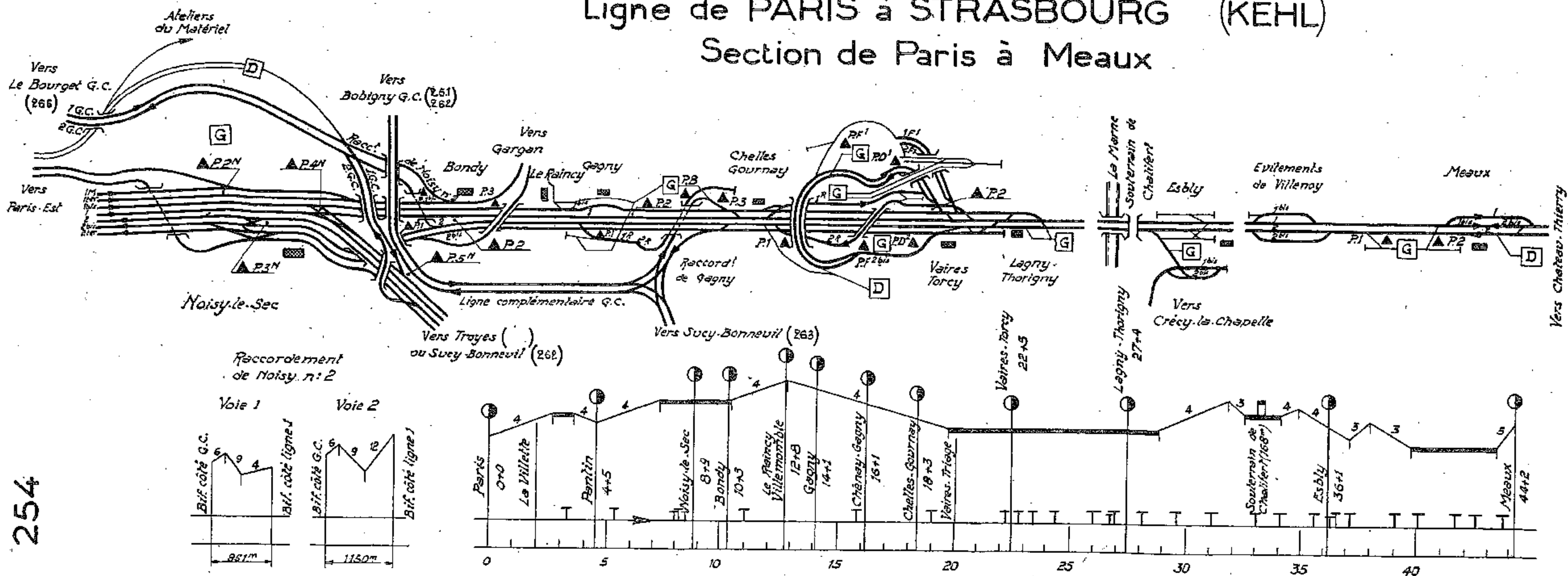

Ligne de PARIS à BALE Section de Romilly-sur-Seine à Troyes.

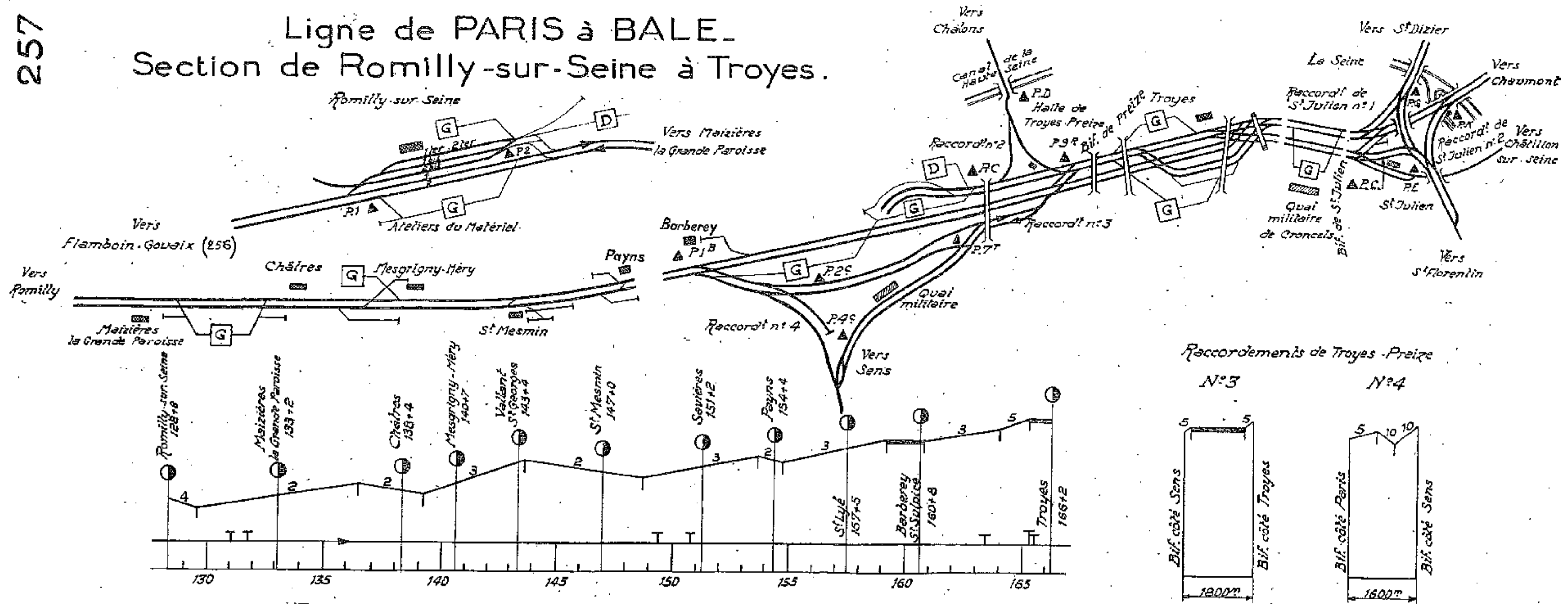

Ligne de PARIS à BALE - Section de Flamboin-Gouaix à Romilly-sur-Seine.

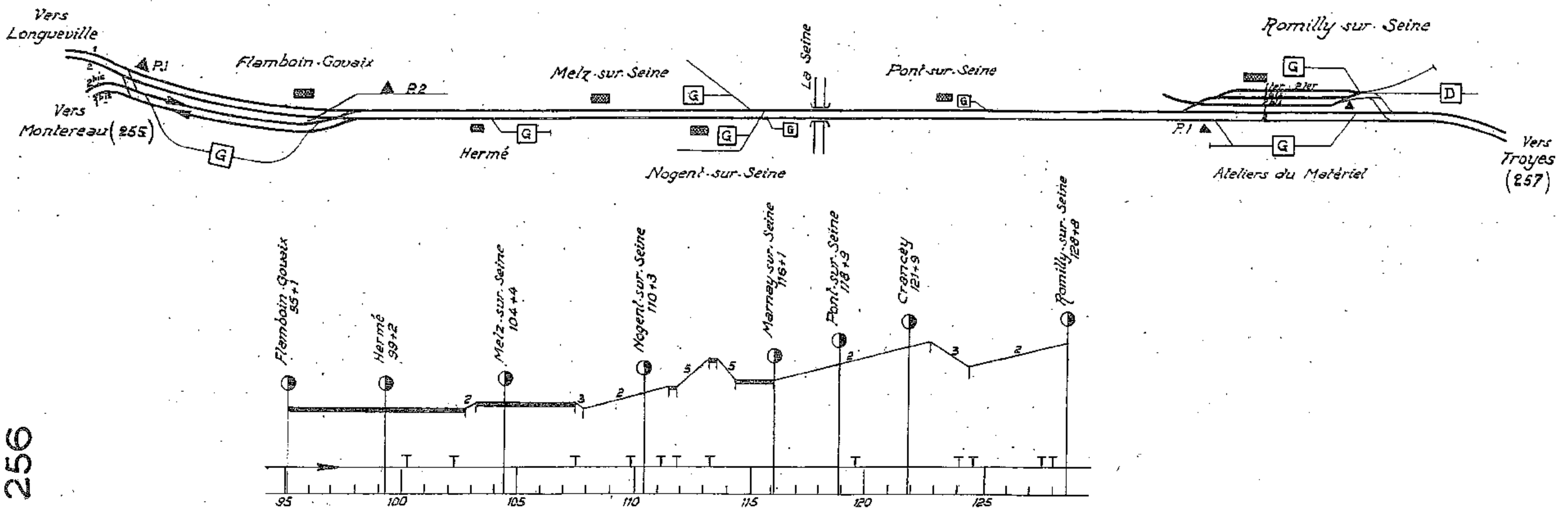

Ligne de PARIS - BASTILLE à VERNEUIL-L'ETANG Section de Sucy-Bonneuil à Verneuil-l'Etang

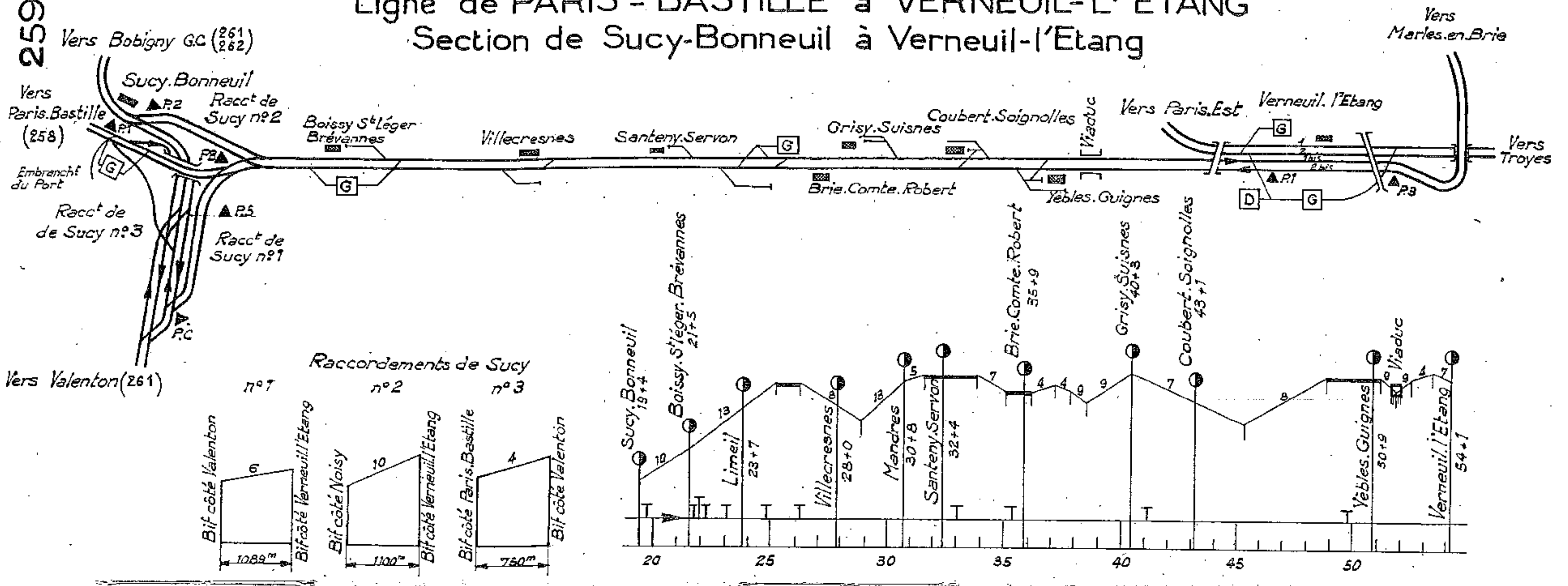

Ligne de PARIS - BASTILLE à VERNEUIL-L'ETANG Section de Paris-Bastille à Sucy-Bonneuil

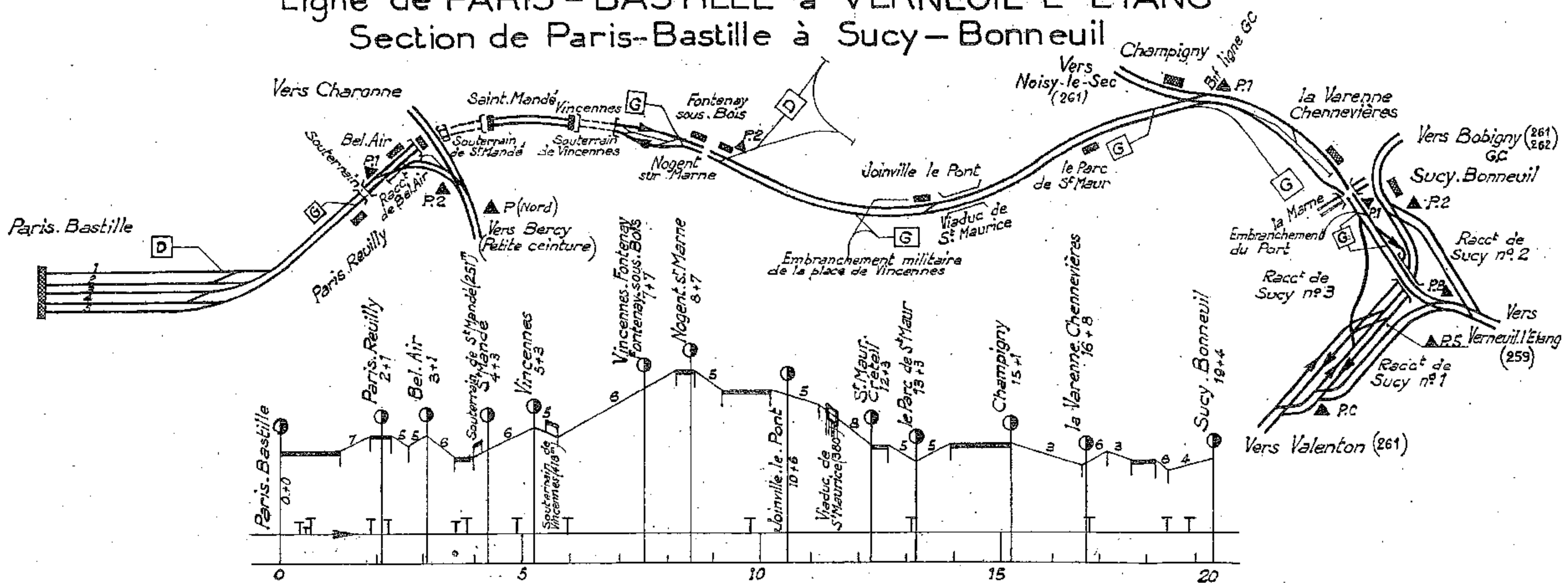

PONT-CARDINET A AUTEUIL-BOULOGNE
AUTEUIL-BOULOGNE A LA RAPÉE-BERCY
PARIS-BATIGNOLLES A LA RAPÉE-BERCY

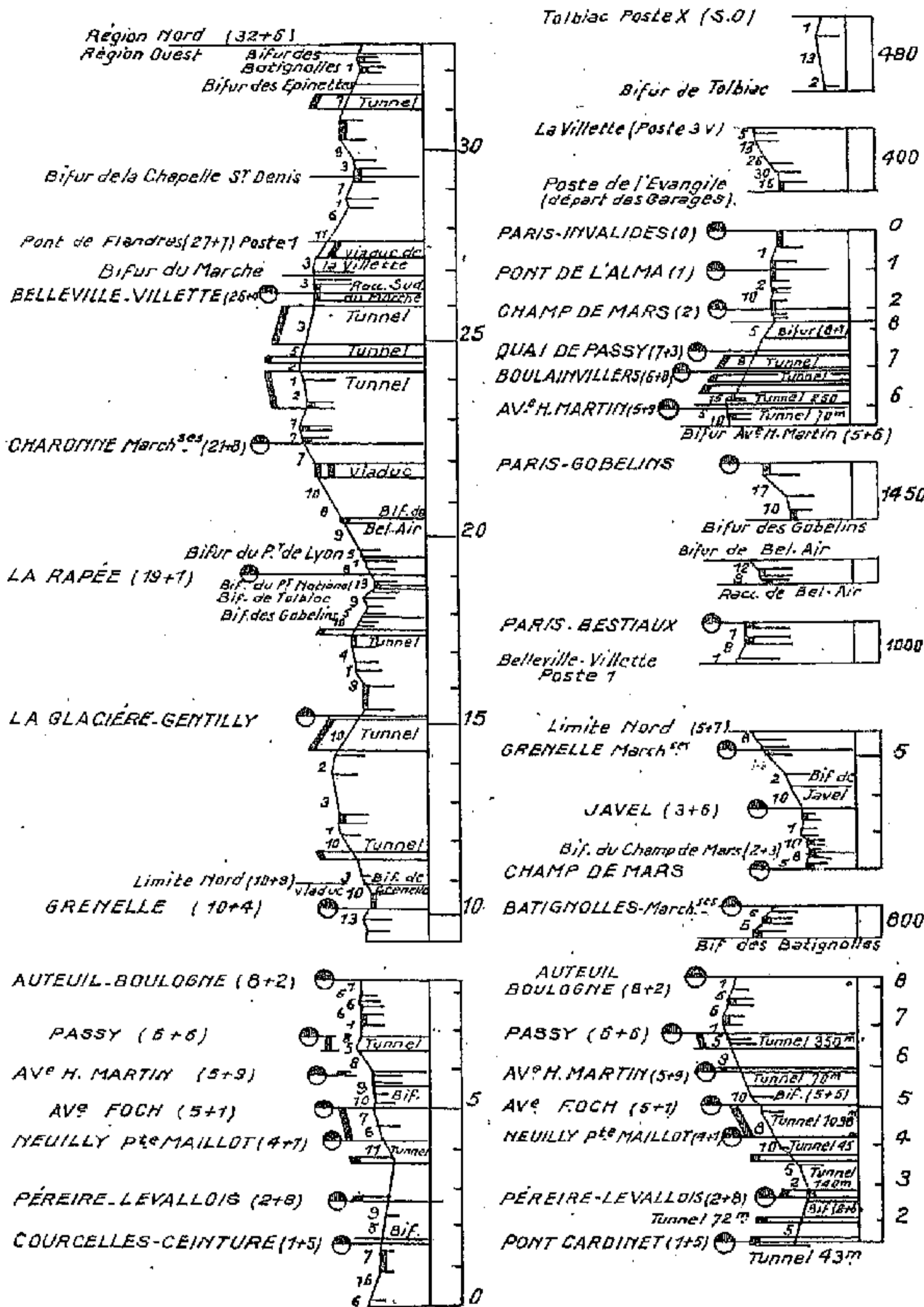

PETITE CEINTURE

Ligne de GRANDE CEINTURE
Section de Bobigny a Valenton

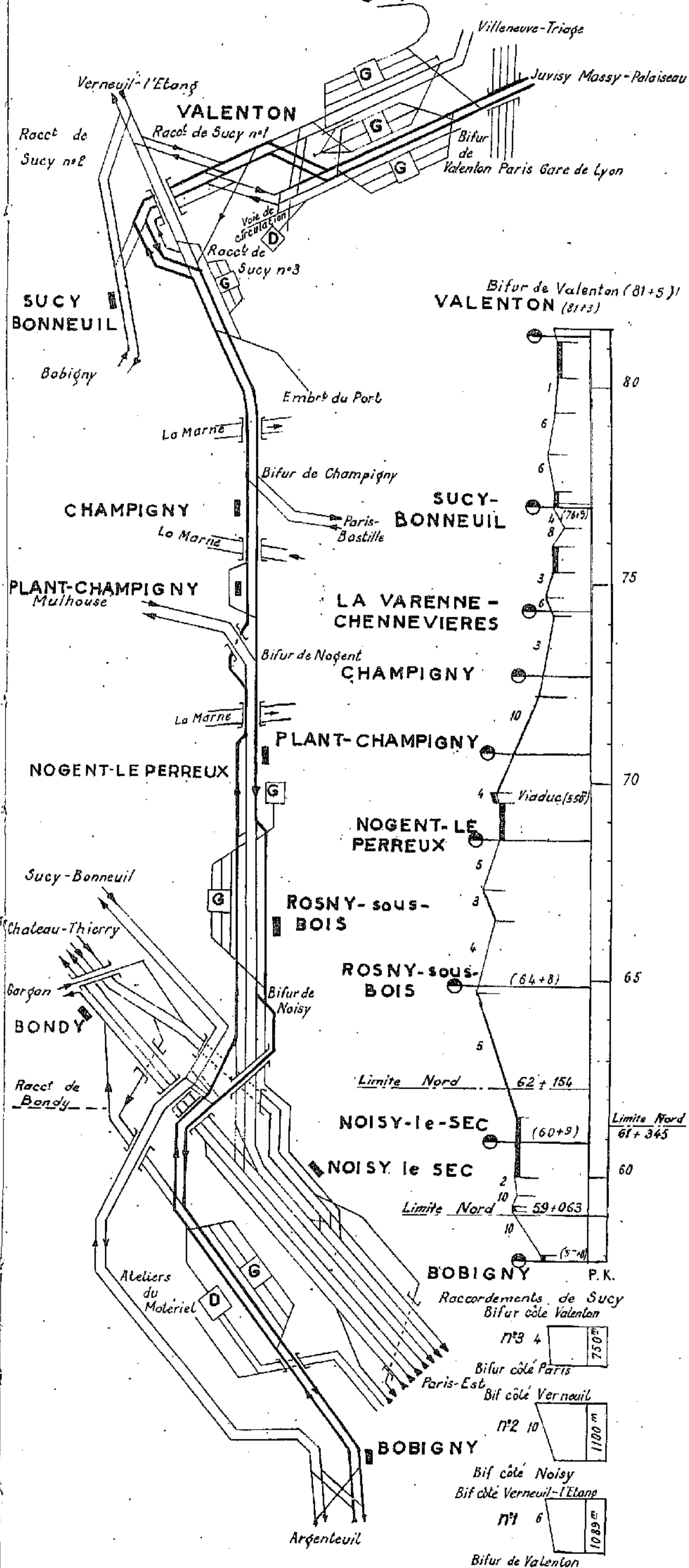

Ligne de BOBIGNY à SUCY BONNEUIL

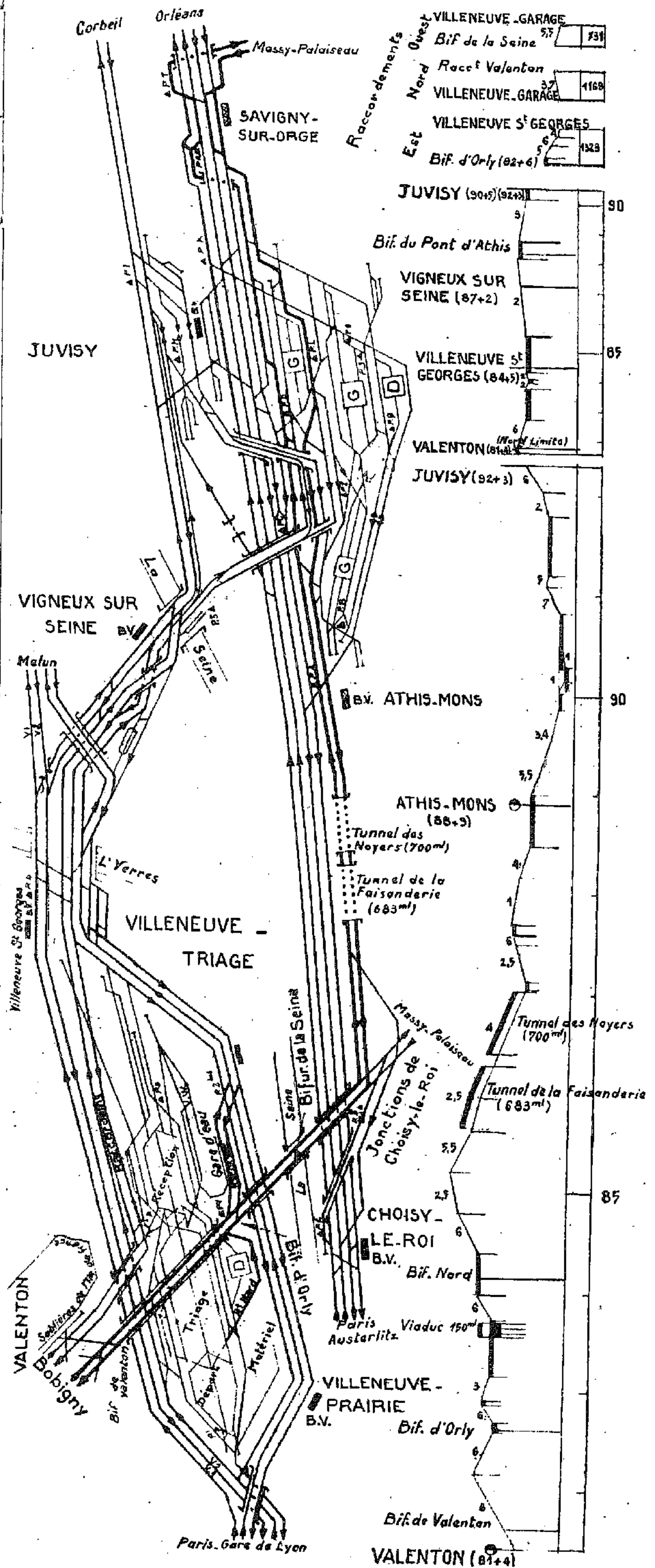
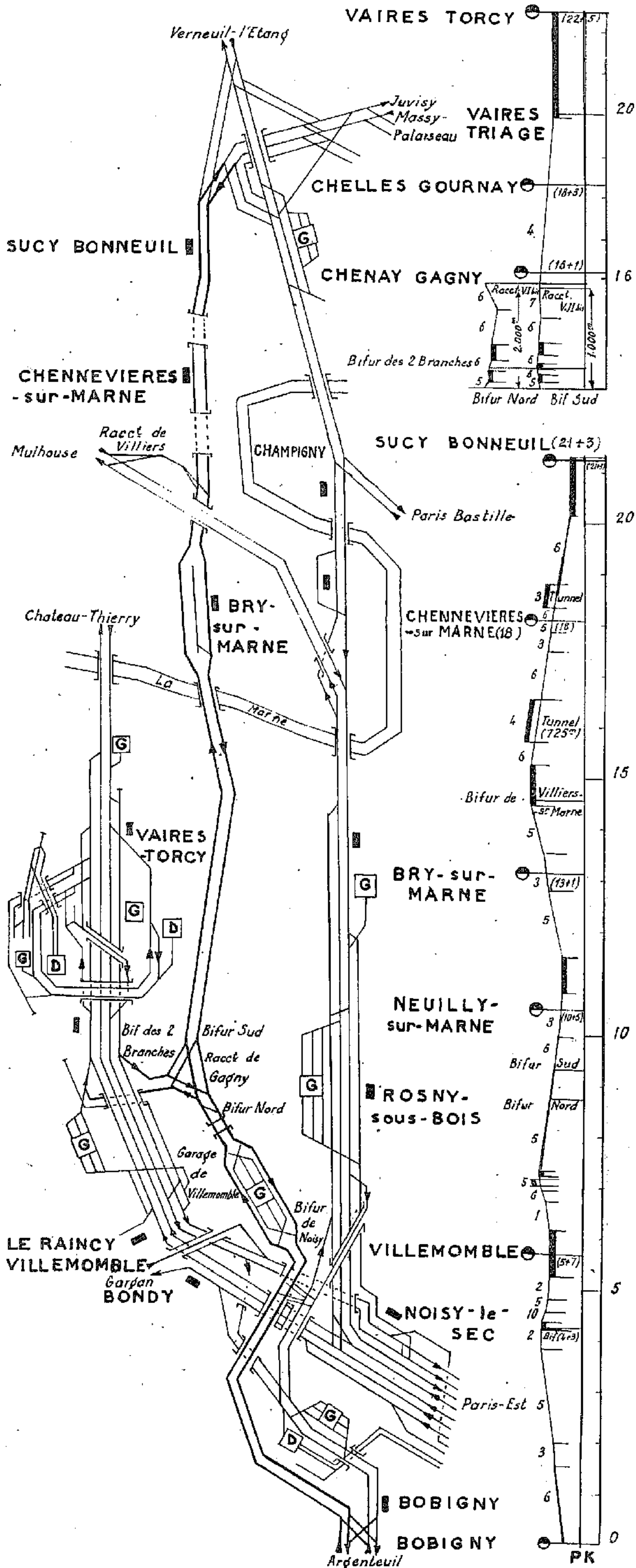

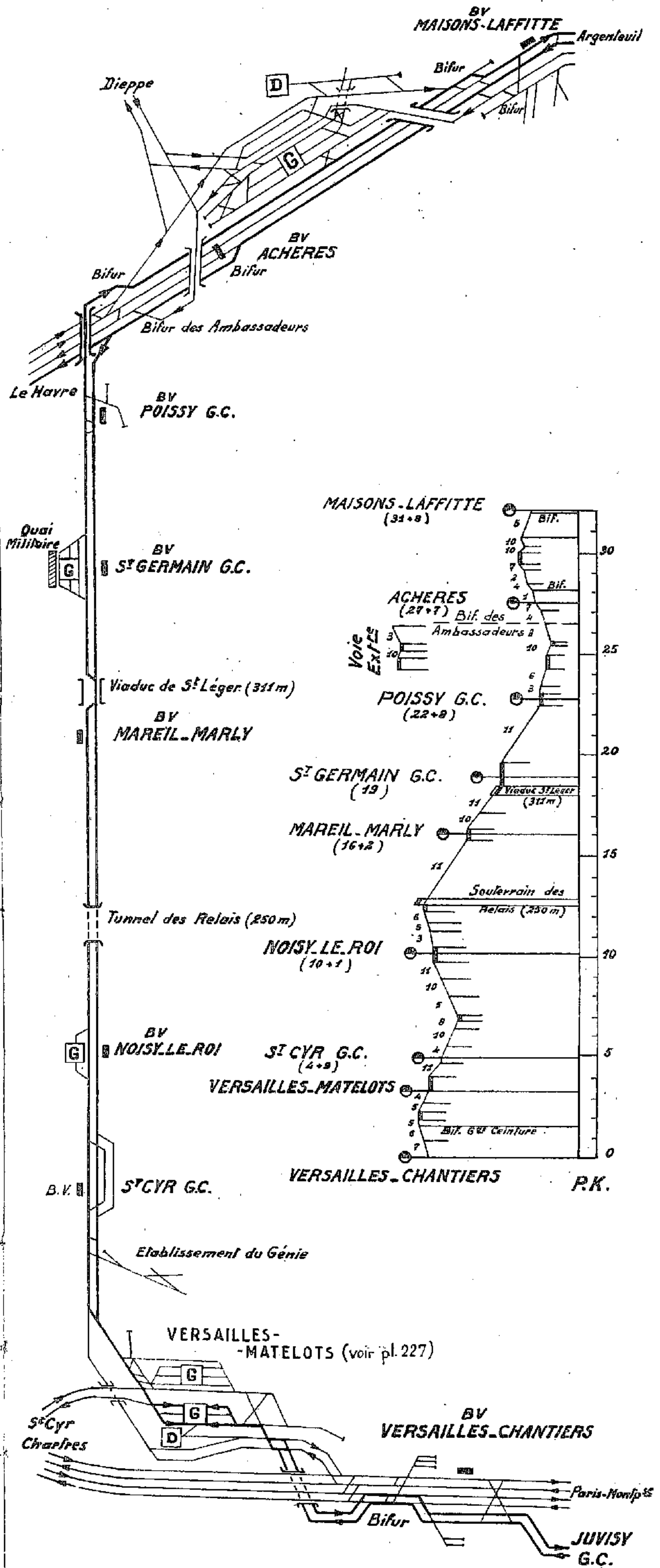
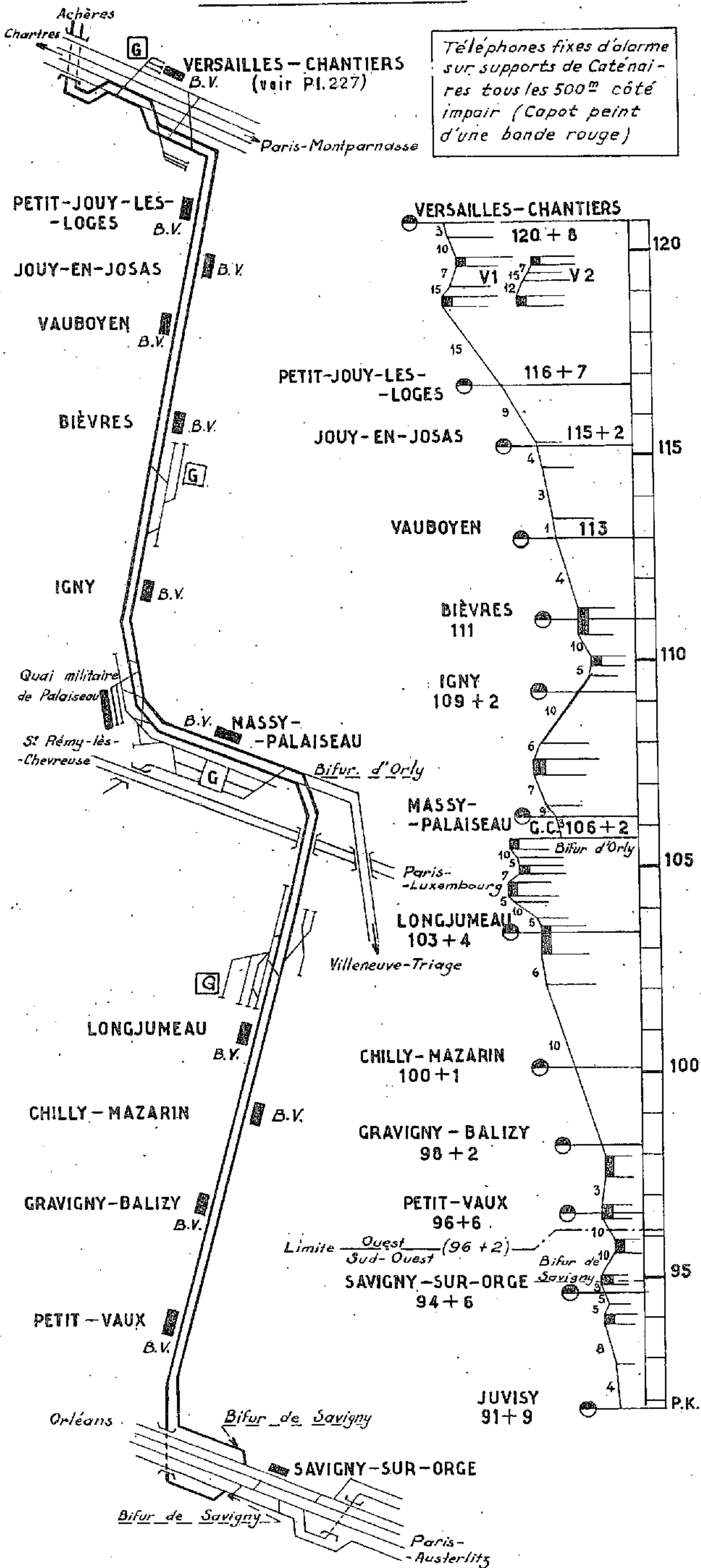

Ligne de GRANDE-CEINTURE Section d'Achères à Bobigny

Noisy-le-Sec

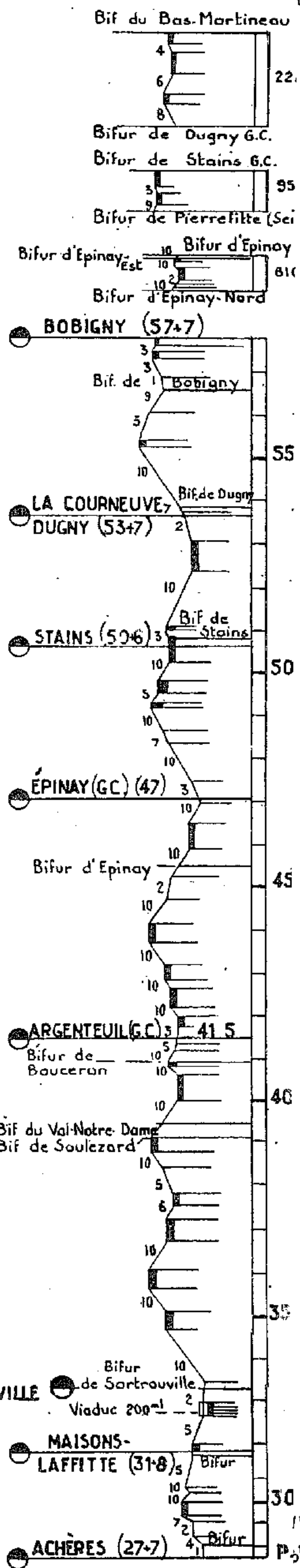
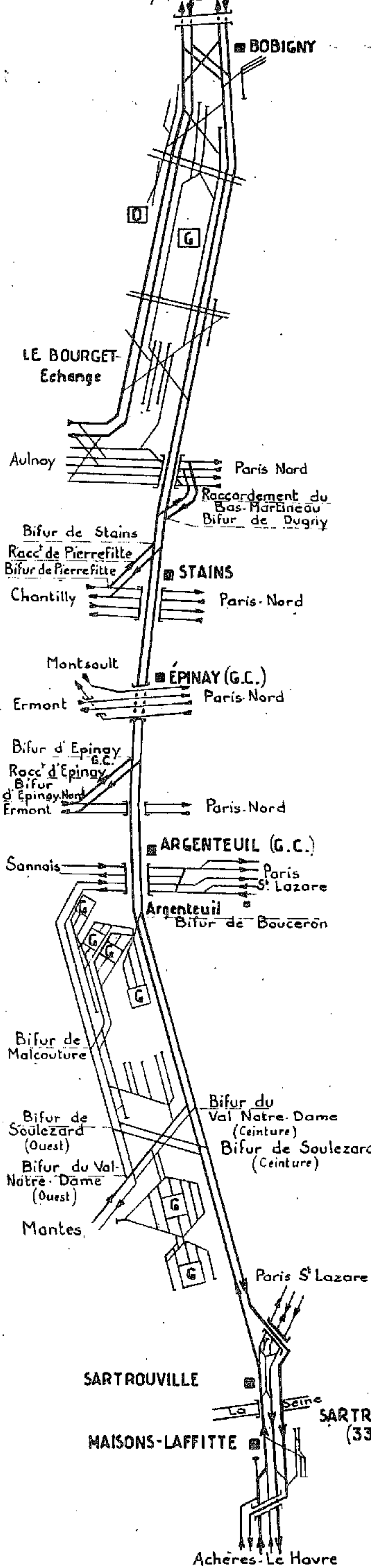

Choisy-Le-Roi à Massy-Palaiseau

De la bifur. de Valenton à la bifur. de Choisy

Telephones fixes d'Alarme sur supports de catenaires tous les 500 m côté impair, (capot peint d'une bande rouge.)

